



Munster Simms Engineering Ltd
 Old Belfast Road, Bangor, Co. Down,
 N. Ireland BT19 1LT.
 Tel: 028 91 270531 Fax: 028 91 466421

www.whalepumps.com Email: sales@whalepumps.com

WHALE® GUSHER® 10 MK3 PUMP

Models: BP3708 and BP3740

READ CAREFULLY BEFORE INSTALLATION AND USE

To the Fitter: Check that the product is suitable for the intended application, follow installation instructions and ensure operating instructions are passed on to the end user.

To the User: Read the following instructions carefully. (See parts diagram).

APPLICATION

This bilge pump is designed to exhaust standing water. Output capacity depends on installation conditions and pumping rate. Users should be aware that capacity may not be sufficient to cope with rapid influx of water.

If it is intended for use for any other purpose or with any other liquid, it is the users' responsibility to ensure that the pump is suitable for the intended use and, in particular, that the materials are fully compatible with the liquids to be used. With all applications it is important that a system of safe working practice is applied to installation, use and maintenance.

INSTALLATION

The Gusher 10 is designed for mounting on or through deck, or on or through bulkhead. The handle can be fixed in four different positions relative to the inlet and outlet. (See Fig. 1).

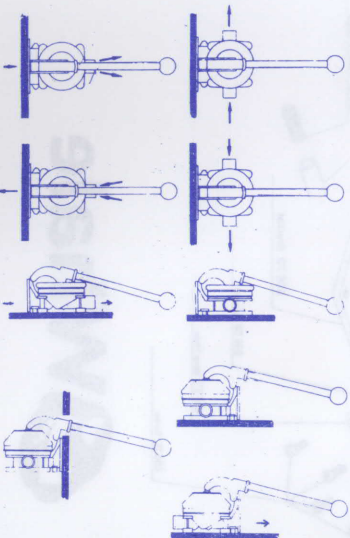

Fig. 1 Some of the many mounting arrangements possible with the standard pump.

To Reposition Handle:

- Slacken wormdrive clip and remove diaphragm.
- Undo the bolts from bracket and rotate body to new position relative to the fork and diaphragm. Note: Inlet and outlet are always at 180 to each other.

c) Reassemble bolts washers and securing bushes in bracket and tighten.

Select a suitable position free from obstructions where the pump can be operated efficiently and comfortably.

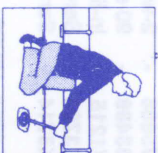

Avoid installations which require a cockpit locker to be opened in order to operate the pump.

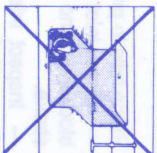

To minimise pumping effort, site the pump halfway (in height) between the stum-box/strainer and hull outlet.

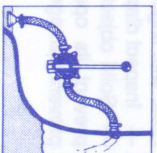

To ensure good priming and flow, avoid sharp bends in pipework and fit a Whale stum-box/strainer (incorporating a non-return valve) which prevents the end of the hose sucking against a flat surface and allows the water level to be reduced to a minimum.

Ensure that the pump is installed to allow easy access for servicing.

For Mounting On Deck/Bulkhead:

- Using pump as template, mark off and drill four 1/4" (6mm) holes.

Fig. 2

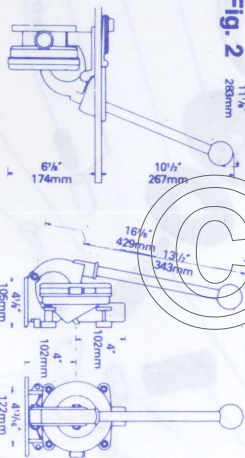

- Check flow direction and secure the pump with 1/4" (6mm) bolts.

- Attach 1 1/2" (38mm) smooth bore reinforced hose with stainless steel worm drive hose clips. Tighten clips to prevent air leaks.

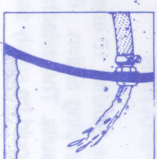

- With thru-hull discharge, make sure that the discharge point is well above the water line

- Check the installation for air leaks, correct priming and discharge.

For Mounting Underdeck or Through Bulkhead:

Three deck plates are available see ACCESSORIES.

- Using template mark off the 6 holes for the mounting and cut out the hole for the pump handle. Round off top edge of large hole as shown in fig. 3.

DECK-FITTING FOR GUSHER PUMPS

HALF SECTIONAL ELEVATION OF DECK-FITTING, PUMP & BRACKET

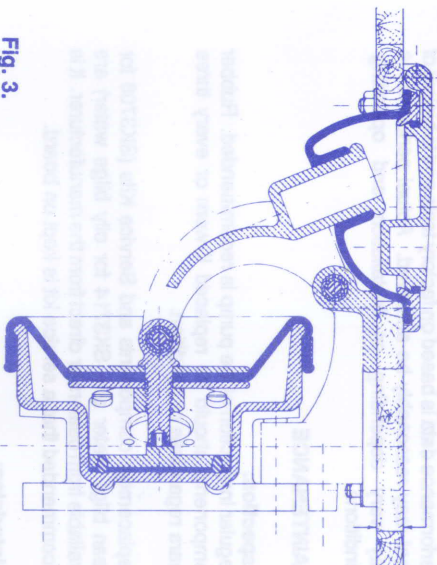

Fig. 3.

- Minimum deck thickness required is 1/4" (6mm). For thinner decks use a backing plate of suitable thickness so that the backing plate plus the deck is at least the minimum thickness and no greater than 1" (25mm). Bond the backing plate to the deck.

Note: If using deck plate DP3804 minimum deck thickness is 1/2" (13mm).

- Position pump under deck and check flow direction. Work the rubber gaffer up through the hole until its flange rests on the deck. Secure the six 1/4" (6mm) countersunk mounting screws provided.

- As points 3, 4 and 5 of previous instructions.