

p70s / p70Rs Pilot Controller

INSTALLATION & OPERATION INSTRUCTIONS

English (EN)

Date: 05-2016

Document number: 81365-2

© 2016 Raymarine UK Limited

SWAB



Raymarine[®]
BY **FLIR**

SWIB

Trademark and patents notice

Raymarine, Tacktick, Clear Pulse, Truzoom, HSB, SeaTalk, SeaTalk^{hs}, SeaTalk^{ng}, Micronet, Raytech, Gear Up, Marine Shield, Seahawk, Autohelm, Automagic, and Visionality are registered or claimed trademarks of Raymarine Belgium.

FLIR, DownVision, SideVision, Dragonfly, Quantum, Instalert, Infrared Everywhere, and The World's Sixth Sense are registered or claimed trademarks of FLIR Systems, Inc.

All other trademarks, trade names, or company names referenced herein are used for identification only and are the property of their respective owners.

This product is protected by patents, design patents, patents pending, or design patents pending.

Fair Use Statement

You may print no more than three copies of this manual for your own use. You may not make any further copies or distribute or use the manual in any other way including without limitation exploiting the manual commercially or giving or selling copies to third parties.

Software updates

Important: Check the Raymarine website for the latest software releases for your product.

www.raymarine.com/software

Product handbooks

The latest versions of all English and translated handbooks are available to download in PDF format from the website www.raymarine.com. Please check the website to ensure you have the latest handbooks.

Copyright ©2016 Raymarine UK Ltd. All rights reserved.

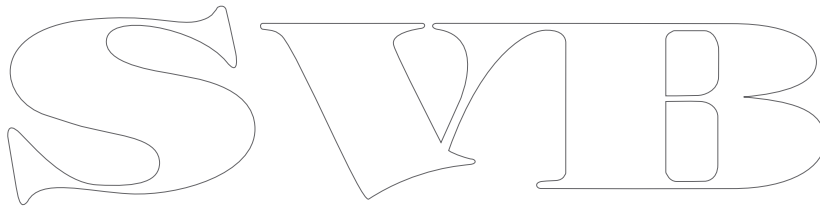

SWIB

Contents

Chapter 1 Important information.....	7	Chapter 7 Commissioning - Evolution autopilot system	41
TFT Displays	8	7.1 Evolution autopilot installation	42
Water ingress	8	7.2 Autopilot commissioning — main differences between Evolution and SPX systems	42
Disclaimer	8	7.3 Autopilot response levels	43
EMC installation guidelines	8	7.4 Initial setup and commissioning	43
Suppression ferrites	8	7.5 Powering the Pilot controller on	44
Connections to other equipment	8	7.6 Using the Set-up Wizard	45
Declaration of conformity	8	7.7 Using the Dockside wizard	45
Product disposal	8	7.8 Adjusting the hard-over time — Evolution	47
Warranty registration	9	7.9 Compass linearization — Evolution autopilots	47
IMO and SOLAS	9	7.10 Compass lock	49
Technical accuracy	9		
Chapter 2 Document and product information.....	11	Chapter 8 Commissioning - SPX and SmartPilot systems	51
2.1 Document information	12	8.1 SPX and SmartPilot autopilot installation	52
2.2 Product overview	13	8.2 Pilot response	52
Chapter 3 Planning the installation	15	8.3 Initial setup and commissioning	53
3.1 Installation checklist	16	8.4 Powering the Pilot controller on	53
3.2 Parts Supplied	16	8.5 Using the Set-up Wizard	54
3.3 Compatible autopilot systems	17	8.6 Dockside calibration	55
3.4 Software updates	17	8.7 Dealer settings	56
3.5 Tools	18	8.8 Adjusting the hard-over time — SmartPilot and SPX	57
3.6 System protocols	18	8.9 Sea trial calibration	57
3.7 Warnings and cautions	19	8.10 Checking autopilot operation	59
3.8 General location requirements	19		
3.9 Unit dimensions	20	Chapter 9 Pilot modes.....	61
Chapter 4 Cables and connections.....	21	9.1 Auto	62
4.1 General cabling guidance	22	9.2 Mode menu	63
4.2 Connections overview	22	9.3 Patterns	63
4.3 SeaTalk ^{ng} ® power supply	23	9.4 Track mode	64
4.4 Cable ferrite installation	25	9.5 Wind vane mode (Sailing boats only)	66
4.5 SeaTalk ^{ng} ® connection	25	9.6 Power steer	68
4.6 SeaTalk connection	26	9.7 Jog steer (tiller pilots only)	69
4.7 NMEA 2000 network connection	27	9.8 Shortcut key	69
Chapter 5 Installation.....	29	Chapter 10 Pilot views	71
5.1 Bezel removal	30	10.1 Available pilot views	72
5.2 Removing the keypad	30	10.2 Graphical view	72
5.3 Mounting	31	10.3 Large view	73
5.4 Refitting the keypad	32	10.4 Standard view	73
Chapter 6 Getting started	33	10.5 Multiple view	74
6.1 Pilot controls	34	10.6 2D View	74
6.2 Before using your product	35	10.7 Setting the pilot view	75
6.3 Powering the Pilot controller on	35	10.8 Setting up data boxes	75
6.4 Completing the startup wizard	36		
6.5 Pilot functions	36	Chapter 11 Pilot controller alarms	77
6.6 Display settings	37	11.1 Alarms	78
6.7 Multiple data sources (MDS) overview	38		
		Chapter 12 Set up menu options	83
		12.1 Set up menu	84
		12.2 Autopilot calibration menu	84

12.3 User preferences menu	92
12.4 System set-up menu.....	94
12.5 Diagnostics menu.....	95
Chapter 13 Maintenance	97
13.1 Routine equipment checks	98
13.2 Product cleaning	98
13.3 Cleaning the display screen	99
13.4 Cleaning the display case	99
13.5 Cleaning the sun cover	100
Chapter 14 System checks and troubleshooting	101
14.1 Troubleshooting	102
14.2 Power up troubleshooting	103
14.3 System data troubleshooting.....	104
14.4 Miscellaneous troubleshooting	105
14.5 Performing a Factory Reset	106
Chapter 15 Technical specification.....	107
15.1 Technical specification	108
Chapter 16 Technical support	109
16.1 Raymarine product support and servicing	110
16.2 Learning resources.....	111
Chapter 17 Spares and accessories	113
17.1 Spares and Accessories	114
17.2 SeaTalk ^{ng} ® cables and accessories	114
17.3 SeaTalk ^{ng} cable kits	116
17.4 SeaTalk accessories.....	119
Appendix A Supported NMEA 2000 PGN list	121
Appendix B Software releases	121

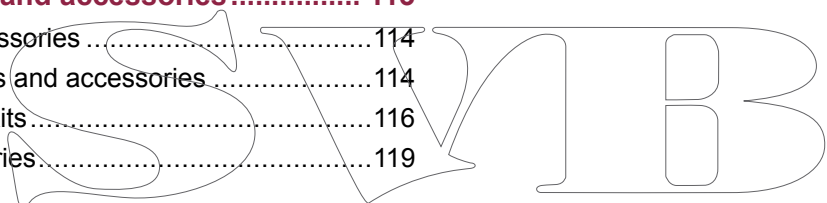

Chapter 1: Important information



Warning: Autopilot system Installation

As correct performance of the vessel's steering is critical for safety, we STRONGLY RECOMMEND that an Authorized Raymarine Service Representative fits this product. You will only receive full warranty benefits if you can show that an Authorized Raymarine Service Representative has installed and commissioned this product.



Warning: Product installation and operation

- This product must be installed and operated in accordance with the instructions provided. Failure to do so could result in personal injury, damage to your vessel and/or poor product performance.
- Raymarine recommends certified installation by a Raymarine approved installer. A certified installation qualifies for enhanced product warranty benefits. Contact your Raymarine dealer for further details, and refer to the separate warranty document packed with your product.



Warning: Maintain a permanent watch

Always maintain a permanent watch, this will allow you to respond to situations as they develop. Failure to maintain a permanent watch puts yourself, your vessel and others at serious risk of harm.



Warning: Ensure safe navigation

This product is intended only as an aid to navigation and must never be used in preference to sound navigational judgment. Only official government charts and notices to mariners contain all the current information needed for safe navigation, and the captain is responsible for their prudent use. It is the user's responsibility to use official government charts, notices to mariners, caution and proper navigational skill when operating this or any other Raymarine product.



Warning: Potential ignition source

This product is NOT approved for use in hazardous/flammable atmospheres. Do NOT install in a hazardous/flammable atmosphere (such as in an engine room or near fuel tanks).



Warning: Product grounding

Before applying power to this product, ensure it has been correctly grounded, in accordance with the instructions provided.



Warning: Positive ground systems

Do not connect this unit to a system which has positive grounding.



Warning: Switch off power supply

Ensure the vessel's power supply is switched OFF before starting to install this product. Do NOT connect or disconnect equipment with the power switched on, unless instructed in this document.



Warning: Power supply voltage

Connecting this product to a voltage supply greater than the specified maximum rating may cause permanent damage to the unit. Refer to the *Technical specification* section for voltage rating.

Caution: Power supply protection

When installing this product ensure the power source is adequately protected by means of a suitably-rated fuse or automatic circuit breaker.

Caution: Sun covers

- If your product is supplied with a sun cover, to protect against the damaging effects of ultraviolet (UV) light, always fit the sun cover when the product is not in use.
- Sun covers must be removed when travelling at high speed, whether in water or when the vessel is being towed.

Caution: Product cleaning

When cleaning products:

- If your product includes a display screen, do NOT wipe the screen with a dry cloth, as this could scratch the screen coating.
- Do NOT use abrasive, or acid or ammonia based products.
- Do NOT use a jet wash.

Caution: Service and maintenance

This product contains no user serviceable components. Please refer all maintenance and repair to authorized Raymarine dealers. Unauthorized repair may affect your warranty.

TFT Displays

The colors of the display may seem to vary when viewed against a colored background or in colored light. This is a perfectly normal effect that can be seen with all color Thin Film Transistor (TFT) displays.

Water ingress

Water ingress disclaimer

Although the waterproof rating capacity of this product meets the stated IPX standard (refer to the product's *Technical Specification*), water intrusion and subsequent equipment failure may occur if the product is subjected to commercial high-pressure washing. Raymarine will not warrant products subjected to high-pressure washing.

Disclaimer

Raymarine does not warrant that this product is error-free or that it is compatible with products manufactured by any person or entity other than Raymarine.

Raymarine is not responsible for damages or injuries caused by your use or inability to use the product, by the interaction of the product with products manufactured by others, or by errors in information utilized by the product supplied by third parties.

EMC installation guidelines

Raymarine equipment and accessories conform to the appropriate Electromagnetic Compatibility (EMC) regulations, to minimize electromagnetic interference between equipment and minimize the effect such interference could have on the performance of your system

Correct installation is required to ensure that EMC performance is not compromised.

Note: In areas of extreme EMC interference, some slight interference may be noticed on the product. Where this occurs the product and the source of the interference should be separated by a greater distance.

For **optimum** EMC performance we recommend that wherever possible:

- Raymarine equipment and cables connected to it are:
 - At least 1 m (3 ft) from any equipment transmitting or cables carrying radio signals e.g. VHF radios, cables and antennas. In the case of SSB radios, the distance should be increased to 7 ft (2 m).
 - More than 2 m (7 ft) from the path of a radar beam. A radar beam can normally be assumed to spread 20 degrees above and below the radiating element.
- The product is supplied from a separate battery from that used for engine start. This is important to

prevent erratic behavior and data loss which can occur if the engine start does not have a separate battery.

- Raymarine specified cables are used.
- Cables are not cut or extended, unless doing so is detailed in the installation manual.

Note: Where constraints on the installation prevent any of the above recommendations, always ensure the maximum possible separation between different items of electrical equipment, to provide the best conditions for EMC performance throughout the installation

Suppression ferrites

- Raymarine cables may be pre-fitted or supplied with suppression ferrites. These are important for correct EMC performance. If ferrites are supplied separately to the cables (i.e. not pre-fitted), you must fit the supplied ferrites, using the supplied instructions.
- If a ferrite has to be removed for any purpose (e.g. installation or maintenance), it must be replaced in the original position before the product is used.
- Use only ferrites of the correct type, supplied by Raymarine or its authorized dealers.
- Where an installation requires multiple ferrites to be added to a cable, additional cable clips should be used to prevent stress on the connectors due to the extra weight of the cable.

Connections to other equipment

Requirement for ferrites on non-Raymarine cables

If your Raymarine equipment is to be connected to other equipment using a cable not supplied by Raymarine, a suppression ferrite **MUST** always be attached to the cable near the Raymarine unit.

Declaration of conformity

Raymarine UK Ltd. declares that this product is compliant with the essential requirements of EMC directive 2004/108/EC.

The original Declaration of Conformity certificate may be viewed on the relevant product page at www.raymarine.com.

Product disposal

Dispose of this product in accordance with the WEEE Directive.



The Waste Electrical and Electronic Equipment (WEEE) Directive requires the recycling of waste electrical and electronic equipment.

Warranty registration

To register your Raymarine product ownership, please visit www.raymarine.com and register online.

It is important that you register your product to receive full warranty benefits. Your unit package includes a bar code label indicating the serial number of the unit. You will need this serial number when registering your product online. You should retain the label for future reference.

IMO and SOLAS

The equipment described within this document is intended for use on leisure marine boats and workboats NOT covered by International Maritime Organization (IMO) and Safety of Life at Sea (SOLAS) Carriage Regulations.

Technical accuracy

To the best of our knowledge, the information in this document was correct at the time it was produced. However, Raymarine cannot accept liability for any inaccuracies or omissions it may contain. In addition, our policy of continuous product improvement may change specifications without notice. As a result, Raymarine cannot accept liability for any differences between the product and this document. Please check the Raymarine website (www.raymarine.com) to ensure you have the most up-to-date version(s) of the documentation for your product.

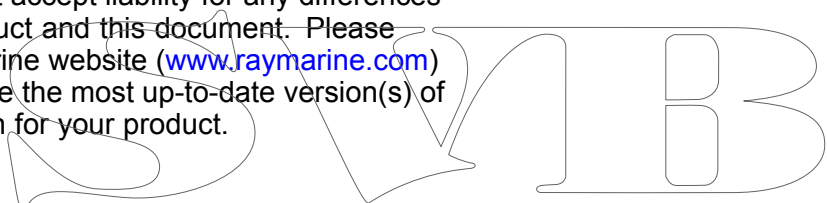

SWIB

Chapter 2: Document and product information

Chapter contents

- [2.1 Document information on page 12](#)
- [2.2 Product overview on page 13](#)

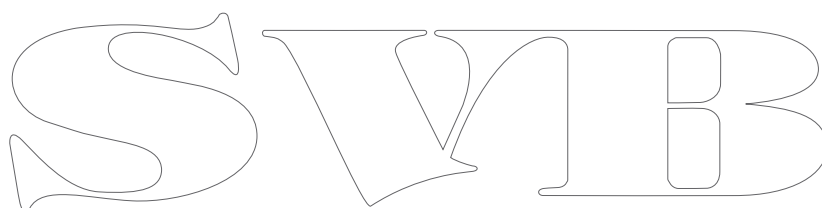
The image shows the letters 'SWIB' in a large, stylized, outlined font. The letters are white with a thin black outline. The 'S' is a simple, rounded shape. The 'W' is composed of two 'V' shapes joined at the top. The 'I' is a simple vertical bar. The 'B' has a rounded top and a vertical stem. The letters are spaced out horizontally.

2.1 Document information

This document contains important information related to the installation of your Raymarine product.

The document includes information to help you:

- plan your installation and ensure you have all the necessary equipment;
- install and connect your product as part of a wider system of connected marine electronics;
- troubleshoot problems and obtain technical support if required.

This and other Raymarine product documents are available to download in PDF format from www.raymarine.com.

Applicable products

This document is applicable to the following products:

	Part number	Name	Description
	E70328	p70s	SeaTalk ^{ng} 8 button pilot controller (Sail)
	E70329	p70Rs	SeaTalk ^{ng} Rotary pilot controller (Power)

Software revision

Raymarine regularly updates product software to add new features and improve existing functionality.

This document covers Pilot controller software — **LightHouse** Version 3.xx, which should be used in conjunction with EV and ACU software version 2.xx.

Please refer to the *Software Releases* section for details on software releases.

Check the **Raymarine**[®] website to ensure you have the latest software and user manuals:

- www.raymarine.com/software
- www.raymarine.com/manuals

Product documentation

The following documentation is applicable to your product:

Description	Part number
p70s / p70Rs Installation and operation instructions	88057 / 81365
p70s / p70Rs Mounting template	87260

Additional handbooks

Description	Part number
SeaTalk ^{ng} [®] reference manual	81300
SeaTalk to SeaTalk ^{ng} [®] converter	87121

Document illustrations

Your product may differ slightly from that shown in the illustrations in this document, depending on product variant and date of manufacture.

All images are provided for illustration purposes only.

2.2 Product overview

The **p70s** and **p70Rs** are **SeaTalk^{ng}** pilot controllers.

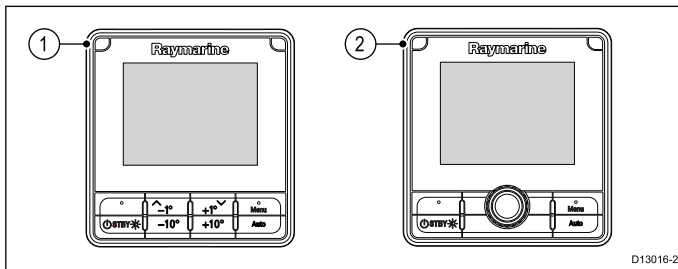

1. **p70s** 8 button (sail) Pilot Controller
2. **p70Rs** Rotary (power) Pilot Controller

The unit has the following features:

- 3.45" high brightness color LCD with wide viewing angles
- **SeaTalk^{ng}**, **NMEA 2000** and **SeaTalk** compatible
- All weather optically bonded LCD
- Large clear characters for easy reading in any conditions
- Easy to use **LightHouseTM** operating system
- 12 V dc operation.
- Low power consumption
- Waterproof to IPx6 and IPx7

SVIB

SWIB

Chapter 3: Planning the installation

Chapter contents

- 3.1 Installation checklist on page 16
- 3.2 Parts Supplied on page 16
- 3.3 Compatible autopilot systems on page 17
- 3.4 Software updates on page 17
- 3.5 Tools on page 18
- 3.6 System protocols on page 18
- 3.7 Warnings and cautions on page 19
- 3.8 General location requirements on page 19
- 3.9 Unit dimensions on page 20

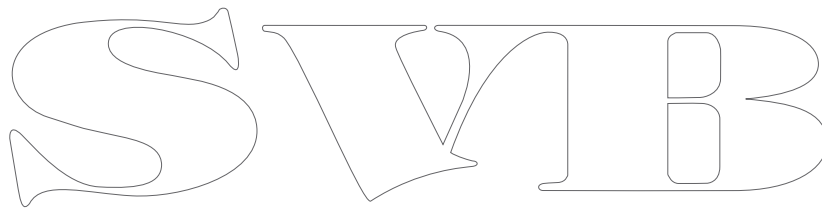

3.1 Installation checklist

Installation includes the following activities:

Installation Task	
1	Plan your system.
2	Obtain all required equipment and tools.
3	Site all equipment.
4	Route all cables.
5	Drill cable and mounting holes.
6	Make all connections into equipment.
7	Secure all equipment in place.
8	Power on and test the system.

Schematic diagram

A schematic diagram is an essential part of planning any installation. It is also useful for any future additions or maintenance of the system. The diagram should include:

- Location of all components.
- Connectors, cable types, routes and lengths.

3.2 Parts Supplied

The following parts are supplied with your product.

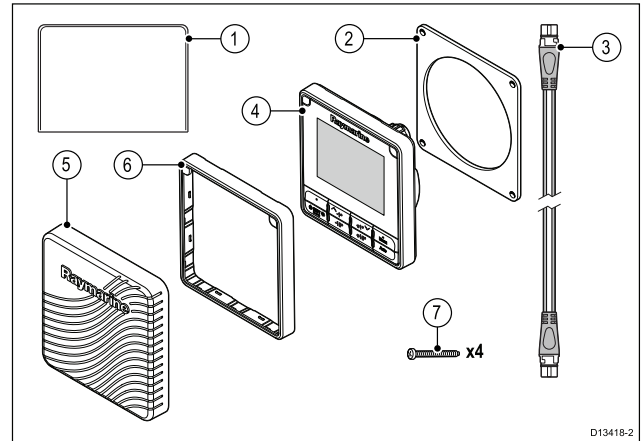

1. Documentation
2. Panel seal gasket
3. 400 mm (15.7 in) **SeaTalkng** spur cable (A06038)
4. **p70s** or **p70Rs** Pilot controller (p70s shown) (supplied with keymat and black bezel (A80353) fitted)
5. Suncover (**p70s** = A80357, **p70Rs** = A80358)
6. Spare gunmetal bezel (A80354)
7. Mounting fixings x 4

Unpack your product carefully to prevent damage or loss of parts, check the box contents against the list above. Retain the packaging and documentation for future reference.

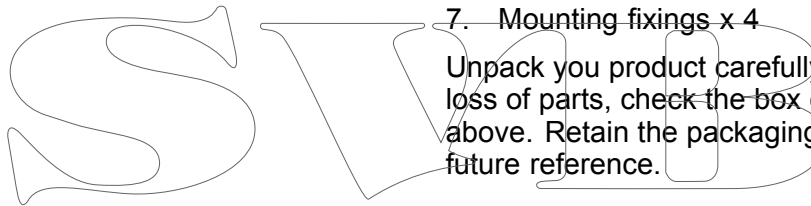

3.3 Compatible autopilot systems

Your product is compatible with the Raymarine Autopilot systems shown below.

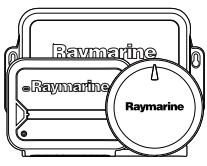
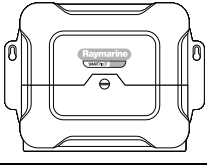
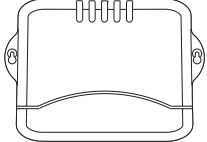
Product	Description	Connection
	Evolution autopilots	SeaTalk ^{ng}
	SPX SmartPilot	SeaTalk ^{ng}
	S1, S2 & S3 SmartPilot	SeaTalk via a SeaTalk to SeaTalk ^{ng} adaptor cable.

3.4 Software updates

The software running on the product can be updated.

- Raymarine periodically releases software updates to improve product performance and add new features.
- You can update the software for your product using a connected and compatible multifunction display.
- Refer to www.raymarine.com/software/ for the latest software updates and the software update procedure for your product.
- If in doubt as to the correct procedure for updating your product software, refer to your dealer or Raymarine technical support.

Caution: Installing software updates

The software update process is carried out at your own risk. Before initiating the update process ensure you have backed up any important files.

Ensure that the unit has a reliable power supply and that the update process is not interrupted.

Damage caused by incomplete updates are not covered by Raymarine warranty.

By downloading the software update package, you agree to these terms.

Evolution software updates

The components of the Evolution autopilot system (EV sensor and ACU) must be upgraded in the correct order.

Using the System Software Update process, available on a **LightHouse™ II** powered MFD running Release 15 or greater, will ensure that the Evolution components are updated in the correct order.

If you are using another method or are updating the system components individually then the EV Sensor **MUST** be updated before the ACU.

Note:

- Updating in the wrong order may cause the autopilot to cease to function.
- After successful completion of the software update process the autopilot will require re-calibration.

3.5 Tools

Tools required for installation

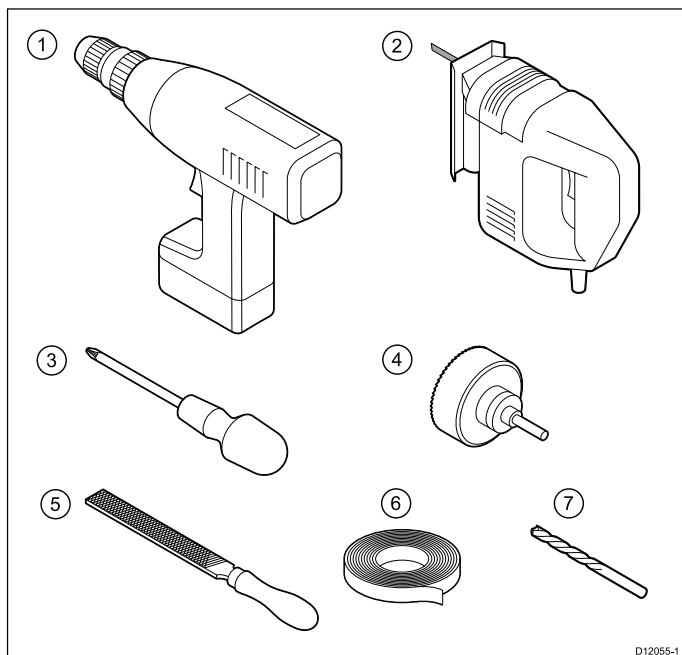

1.	Power drill
2.	Jig saw
3.	Screwdriver
4.	Suitable size (10 mm to 30 mm) hole cutter
5.	File
6.	Adhesive tape
7.	Drill bit of appropriate size ⁽¹⁾

Note: (1) Drill bit size is dependent on the thickness and type of material that the unit is to be mounted on.

3.6 System protocols

Your product can be connected to various products and systems to share information and so improve the functionality of the overall system. These connections may be made using a number of different protocols. Fast and accurate data collection and transfer is achieved by using a combination of the following data protocols:

- **SeaTalk^{ng}**
- **NMEA 2000**
- **SeaTalk**

Note: You may find that your system does not use all of the connection types or instrumentation described in this section.

Seataalk^{ng}

SeaTalk^{ng} (Next Generation) is an enhanced protocol for connection of compatible marine instruments and equipment. It replaces the older **SeaTalk** and **SeaTalk²** protocols.

SeaTalk^{ng} utilizes a single backbone to which compatible instruments connect using a spur. Data and power are carried within the backbone. Devices that have a low draw can be powered from the network, although high current equipment will need to have a separate power connection.

SeaTalk^{ng} is a proprietary extension to **NMEA 2000** and the proven CAN bus technology. Compatible **NMEA 2000** and **SeaTalk / SeaTalk²** devices can also be connected using the appropriate interfaces or adaptor cables as required.

NMEA 2000

NMEA 2000 offers significant improvements over **NMEA 0183**, most notably in speed and connectivity. Up to 50 units can simultaneously transmit and receive on a single physical bus at any one time, with each node being physically addressable. The standard was specifically intended to allow for a whole network of marine electronics from any manufacturer to communicate on a common bus via standardized message types and formats.

SeaTalk

SeaTalk is a protocol which enables compatible instruments to connect to each other and share data.

The **SeaTalk** cable system is used to connect compatible instruments and equipment. The cable carries power and data and enables connection without the need for a central processor.

Additional instruments and functions can be added to a **SeaTalk** system, simply by plugging them into the network. **SeaTalk** equipment can also communicate with other non-SeaTalk equipment via the **NMEA 0183** standard, provided a suitable interface is used.

3.7 Warnings and cautions

Important: Before proceeding, ensure that you have read and understood the warnings and cautions provided in the [Chapter 1 Important information](#) section of this document.

3.8 General location requirements

Important considerations when choosing a suitable location for your product.

This product is suitable for mounting above or below decks.

The product should be mounted where it will be:

- protected from physical damage and excessive vibration.
- well ventilated and away from heat sources.
- away from any potential ignition source such as an engine room, near fuel tanks or a gas locker.

When choosing a location for the product, consider the following points to ensure reliable and trouble-free operation:

- **Access** — there must be sufficient space to enable cable connections to the product, avoiding tight bends in the cable.
- **Diagnostics** — the product must be mounted in a location where the diagnostics LED is easily visible.

Note: Not all products include a diagnostics LED. Refer to the [Chapter 14 System checks and troubleshooting](#) for more information.

- **Electrical interference** — the product should be mounted far enough away from any equipment that may cause interference such as motors, generators and radio transmitters / receivers.
- **Magnetic compass** — refer to the *Compass safe distance* section in this document for advice on maintaining a suitable distance between this product and any compasses on your vessel.
- **Power** — to keep cable runs to a minimum, the product must be located as close as possible to the vessel's dc power supply.
- **Mounting surface** — ensure the product is adequately supported on a secure surface. Refer to the weight information provided in the *Technical specification* for this product and ensure that the intended mounting surface is suitable for bearing the product weight. Do NOT mount units or cut holes in places which may damage the structure of the vessel.

SVT

Site Requirements

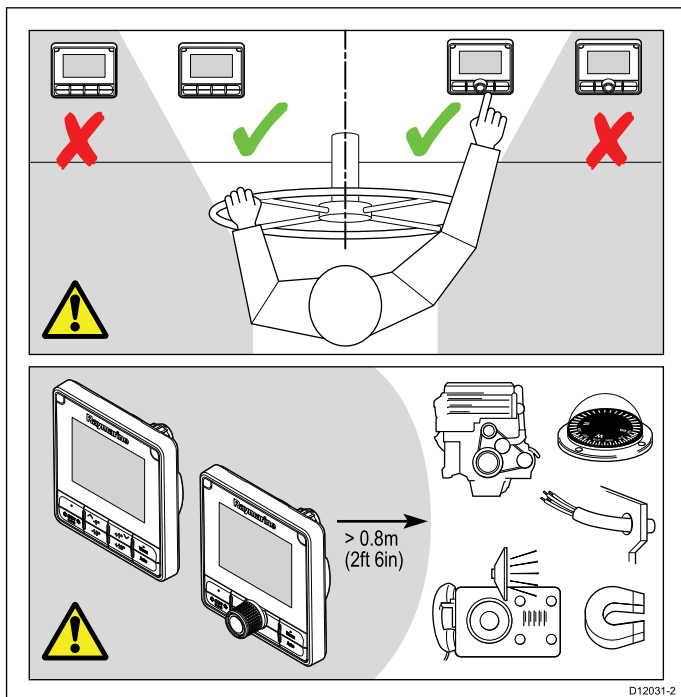

3.9 Unit dimensions

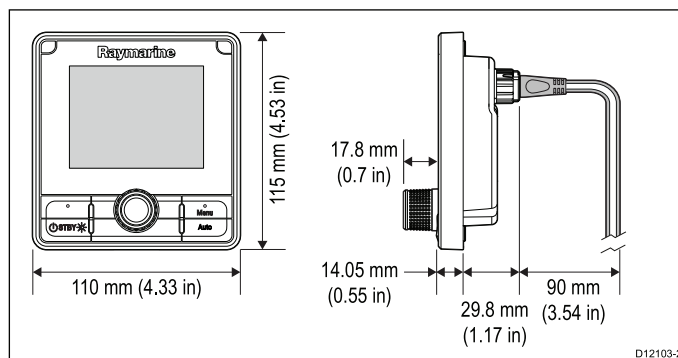

Site requirements for the **p70s / p70Rs** Pilot controller are as follows:

- There should be no obstacle between the user and the pilot controller.
- The pilot controller should be situated at least 0.8 m from an engine, compass, high current power cables, or any magnetic device.

Viewing angle considerations

As display contrast, color and night mode performance are all affected by the viewing angle, Raymarine recommends you temporarily power up the display when planning the installation, to enable you to best judge which location gives the optimum viewing angle.

Chapter 4: Cables and connections

Chapter contents

- [4.1 General cabling guidance on page 22](#)
- [4.2 Connections overview on page 22](#)
- [4.3 SeaTalk^{ng}® power supply on page 23](#)
- [4.4 Cable ferrite installation on page 25](#)
- [4.5 SeaTalk^{ng}® connection on page 25](#)
- [4.6 SeaTalk connection on page 26](#)
- [4.7 NMEA 2000 network connection on page 27](#)

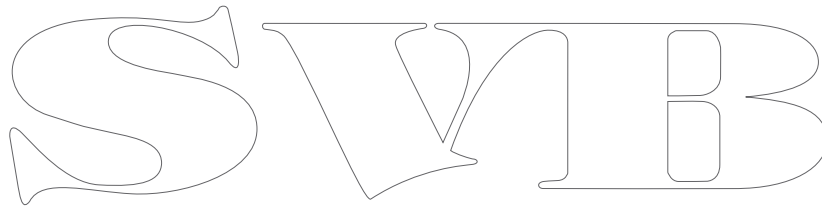

4.1 General cabling guidance

Cable types and length

It is important to use cables of the appropriate type and length

- Unless otherwise stated use only standard cables of the correct type, supplied by Raymarine.
- Ensure that any non-Raymarine cables are of the correct quality and gauge. For example, longer power cable runs may require larger wire gauges to minimize voltage drop along the run.

Routing cables

Cables must be routed correctly, to maximize performance and prolong cable life.

- Do NOT bend cables excessively. Wherever possible, ensure a minimum bend diameter of 200 mm (8 in) / minimum bend radius of 100 mm (4 in).

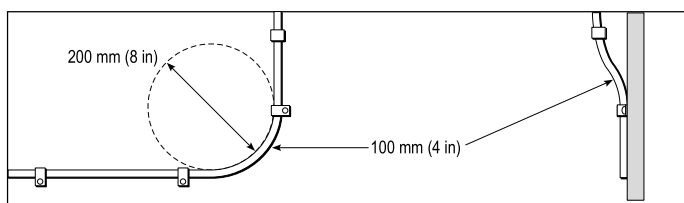

- Protect all cables from physical damage and exposure to heat. Use trunking or conduit where possible. Do NOT run cables through bilges or doorways, or close to moving or hot objects.
- Secure cables in place using tie-wraps or lacing twine. Coil any extra cable and tie it out of the way.
- Where a cable passes through an exposed bulkhead or deckhead, use a suitable watertight feed-through.
- Do NOT run cables near to engines or fluorescent lights.

Always route data cables as far away as possible from:

- other equipment and cables,
- high current carrying AC and DC power lines,
- antennae.

Caution: Pulling cables

Do NOT use cords or ropes, attached to cable connectors, to pull cables through restricted apertures (e.g. as in bulkheads), as this could cause damage to cables.

Strain relief

Ensure adequate strain relief is provided. Protect connectors from strain and ensure they will not pull out under extreme sea conditions.

Cable shielding

Ensure that all data cables are properly shielded that the cable shielding is intact (e.g. hasn't been scraped off by being squeezed through a tight area).

4.2 Connections overview

Use the following information to help you identify the connections on your product.

Connector	Qty	Connects to:	Suitable cables
	1	<ol style="list-style-type: none"> 1. SeaTalk^{ng} backbone 2. NMEA 2000 backbone 3. SeaTalk backbone 	<ol style="list-style-type: none"> 1. SeaTalk^{ng} spur cables 2. SeaTalk^{ng} to DeviceNet adaptor cable (A06045) 3. SeaTalk to SeaTalk^{ng} adaptor cable (A06073)

Connecting SeaTalk^{ng}® cables

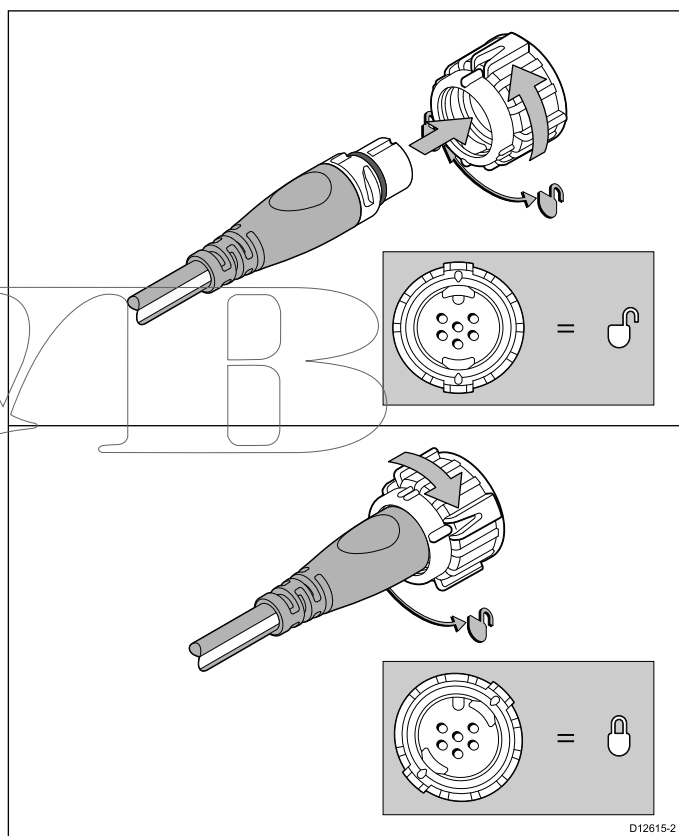

1. Rotate the locking collar on the unit to the unlocked position.
2. Ensure the cable's connector is correctly oriented.
3. Fully insert the cable connector.
4. Rotate locking collar clockwise (2 clicks) until it is in the locked position.

SeaTalk^{ng}® product loading

The number of products that can be connected to a **SeaTalk^{ng}** backbone depends on the power consumption of each product and the physical overall length of the backbone.

SeaTalk^{ng} products have a Load Equivalency Number (LEN), which indicates the product's power consumption. The LEN for each product can be found in the product's Technical Specification.

4.3 SeaTalk^{ng}® power supply

Power is supplied to the product over the **SeaTalk^{ng}** backbone.

A **SeaTalk^{ng}** backbone requires one 12 V dc power supply, connected to the **SeaTalk^{ng}** backbone. This can be provided by:

- a battery ⁽¹⁾, via the distribution panel,
- an Autopilot Control Unit (**ACU**)⁽²⁾,
- an **SPX** course computer ⁽²⁾,
- for 24 V vessels a 5 amp, regulated, continuous 24 V dc to 12 V dc converter is required.

Note:

- (1) The battery used for starting the vessel's engine(s) should NOT be used to power the **SeaTalk^{ng}** backbone as this can cause sudden voltage drops, when the engines are started.
- (2) The **ACU-100** and **SPX-5** cannot be used to power the **SeaTalk^{ng}** backbone.

SeaTalk^{ng}® power connection point

Small systems

If the backbone length is 60 m (197 ft) or less, the power connection point may be connected at any point in the backbone.

Large systems

If the backbone length is greater than 60 m (197 ft), the power connection point should be connected at a point that creates a balanced current draw from each side of the backbone. The Load Equivalency Number (LEN) is used to determine the power connection point for the system.

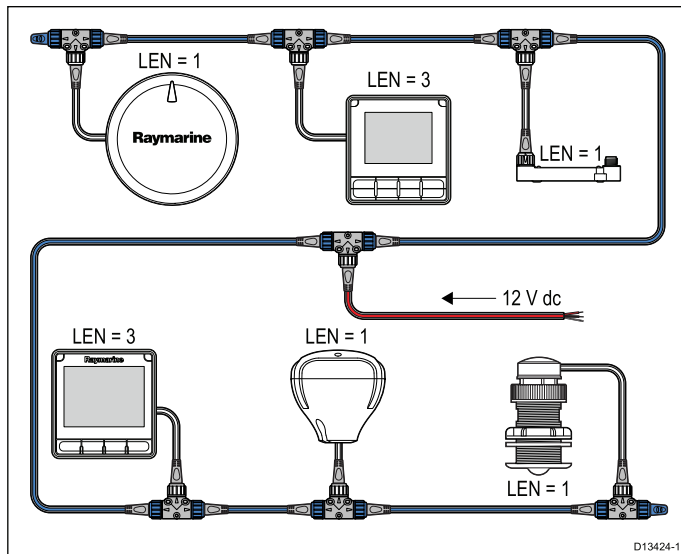

In the example above the system has an overall LEN of 10, so the optimum connection point would be to have 5 LEN either side of the connection point.

In-line fuse and thermal breaker ratings

The **SeaTalk^{ng}** network's power supply requires an in-line fuse or thermal breaker to be fitted.

In-line fuse rating	Thermal breaker rating
5 A	3 A (if only connecting one device)

Note:

- The suitable fuse rating for the thermal breaker is dependent on the number of devices you are connecting. If in doubt consult an authorized Raymarine dealer.

SeaTalk^{ng}® system loading

The maximum loading / LEN for a **SeaTalk^{ng}** system depends on the length of the backbone.

Loading type	Backbone length	Total LEN
Unbalanced	20 m (66 ft)	40
Unbalanced	40 m (131 ft)	20
Unbalanced	60 m (197 ft)	14
Balanced	60 m (197 ft) or less	100
Balanced	80 m (262 ft)	84
Balanced	100 m (328 ft)	60
Balanced	120 m (394 ft)	50
Balanced	140 m to 160 m (459 ft to 525 ft)	40
Balanced	180 m to 200 m (591 ft to 656 ft)	32

Power distribution — SeaTalk^{ng}®

Recommendations and best practice.

- Only use approved **SeaTalk^{ng}** power cables. Do NOT use a power cable designed for, or supplied with, a different product.
- See below for more information on implementation for some common power distribution scenarios.

Important: When planning and wiring, take into consideration other products in your system, some of which (e.g. sonar modules) may place large power demand peaks on the vessel's electrical system.

Note: The information provided below is for guidance only, to help protect your product. It covers common vessel power arrangements, but does NOT cover every scenario. If you are unsure how to provide the correct level of protection, please consult an authorized Raymarine dealer or a suitably qualified professional marine electrician.

Implementation — direct connection to battery

- **SeaTalk^{ng}** power cables may be connected directly to the vessel's battery, via a suitably rated fuse or breaker.

- You **MUST** fit a suitably rated fuse or breaker between the red wire and the battery's positive terminal.
- Refer to the inline fuse ratings provided in the product's documentation.
- If you need to extend the length of the power cable, ensure you use suitably rated cable and that sufficient power (12 V dc) is available at the **SeaTalk^{ng}** backbone's power connection.

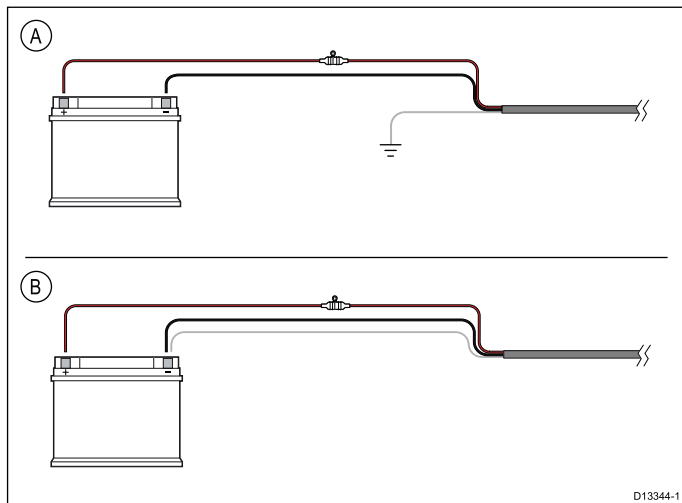

A	Battery connection scenario A: suitable for a vessel with a common RF ground point. In this scenario, if your product's power cable is supplied with a separate drain wire then it should be connected to the vessel's common ground point.
B	Battery connection scenario B: suitable for a vessel without a common grounding point. In this case, if your product's power cable is supplied with a separate drain wire then it should be connected directly to the battery's negative terminal.

Implementation — connection to distribution panel

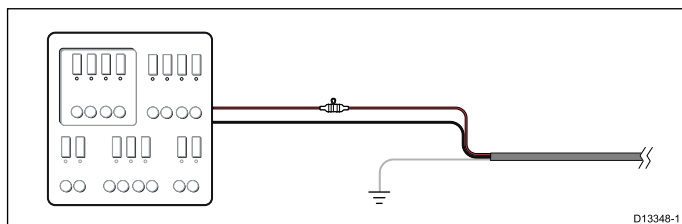

- Alternatively, the **SeaTalk^{ng}** power cable may be connected to a suitable breaker or switch on the vessel's distribution panel or factory-fitted power distribution point.
- The distribution point should be fed from the vessel's primary power source by 8 AWG (8.36 mm²) cable.
- Ideally, all equipment should be wired to individual suitably-rated thermal breakers or fuses, with appropriate circuit protection. Where this is not possible and more than 1 item of equipment shares a breaker, use individual in-line fuses for each power circuit to provide the necessary protection.
- In all cases, observe the recommended breaker / fuse ratings provided in the product's documentation.

- If you need to extend the length of the power cable, ensure you use suitably rated cable and that sufficient power (12 V dc) is available at the **SeaTalk^{ng}** backbone's power connection.

Important: Be aware that the suitable fuse rating for the thermal breaker or fuse is dependent on the number of devices you are connecting.

More information

Raymarine recommends that best practice is observed in all vessel electrical installations, as detailed in the following standards:

- BMEA Code of Practice for Electrical and Electronic Installations in Boats
- NMEA 0400 Installation Standard
- ABYC E-11 AC & DC Electrical Systems on Boats
- ABYC A-31 Battery chargers and Inverters
- ABYC TE-4 Lightning Protection

Sharing a breaker

Where more than 1 piece of equipment shares a breaker you must provide protection for the individual circuits. E.g. by connecting an in-line fuse for each power circuit.

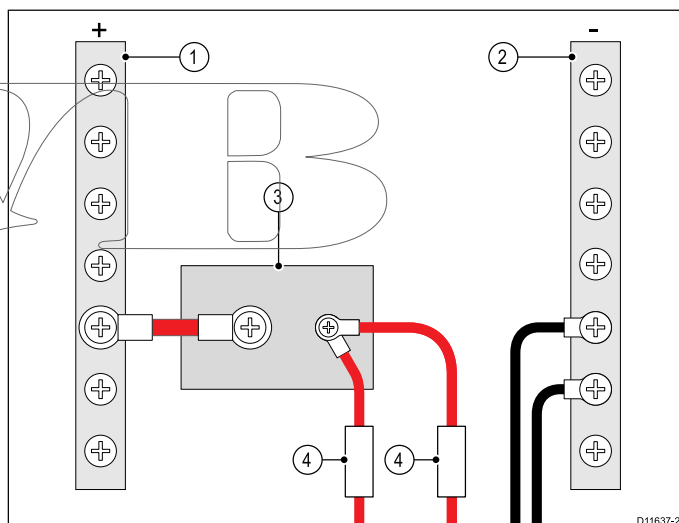

1	Positive (+) bar
2	Negative (-) bar
3	Circuit breaker
4	Fuse

Where possible, connect individual items of equipment to individual circuit breakers. Where this is not possible, use individual in-line fuses to provide the necessary protection.

Warning: Product grounding

 Before applying power to this product, ensure it has been correctly grounded, in accordance with the instructions provided.

Warning: Positive ground systems

 Do not connect this unit to a system which has positive grounding.

4.4 Cable ferrite installation

Your product is supplied with a cable ferrite. To ensure EMC Compliance, the supplied ferrite must be fitted to the cable according to the following instructions.

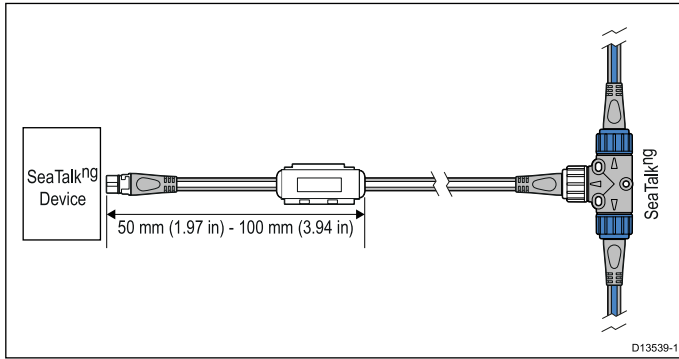

1. The ferrite must be fitted to the end of the cable closest to the device.
2. The ferrite must be fitted at the distance specified in the illustration above.
3. Ensure a tight and secure fit so that the ferrite will not move up or down the cable.

4.5 SeaTalkng® connection

The unit connects as part of a **SeaTalkng** network.

Example: SeaTalkng® system with Evolution autopilot and iTC-5

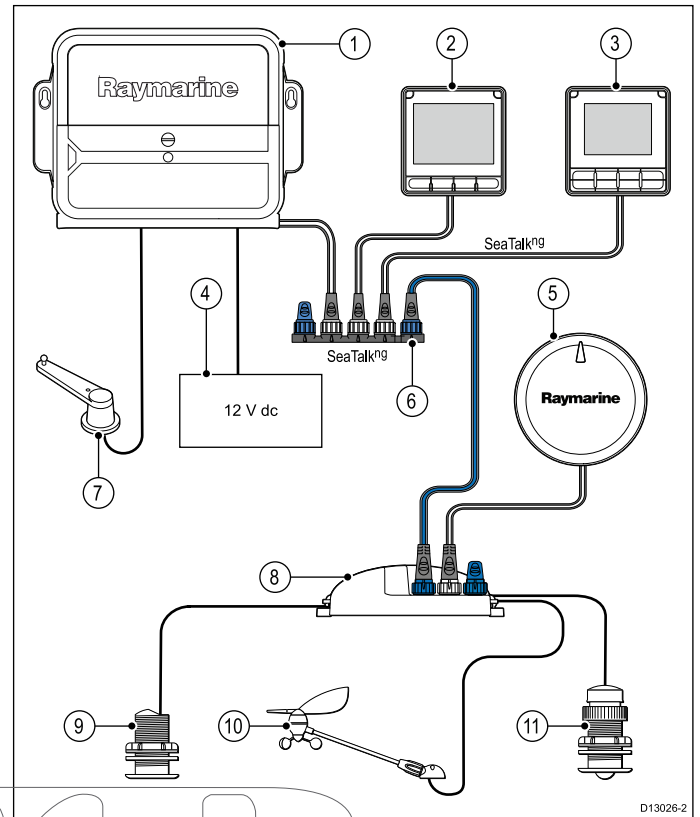

1	ACU unit
2	i70s Multifunction instrument display
3	p70s / p70Rs Pilot controller (p70s shown)
4	Vessel's 12 V dc power supply
5	EV unit
6	SeaTalkng 5-way connector
7	Rudder reference transducer
8	iTC-5 converter
9	Depth transducer
10	Wind transducer
11	Speed transducer

Note: In the above example if an **ACU-100** were used, the **SeaTalkng** network would require a dedicated 12 V dc power supply because the **ACU-100** does not supply power to the **SeaTalkng** network.

Example: SeaTalk^{ng}® system with SPX SmartPilot and transducer pods

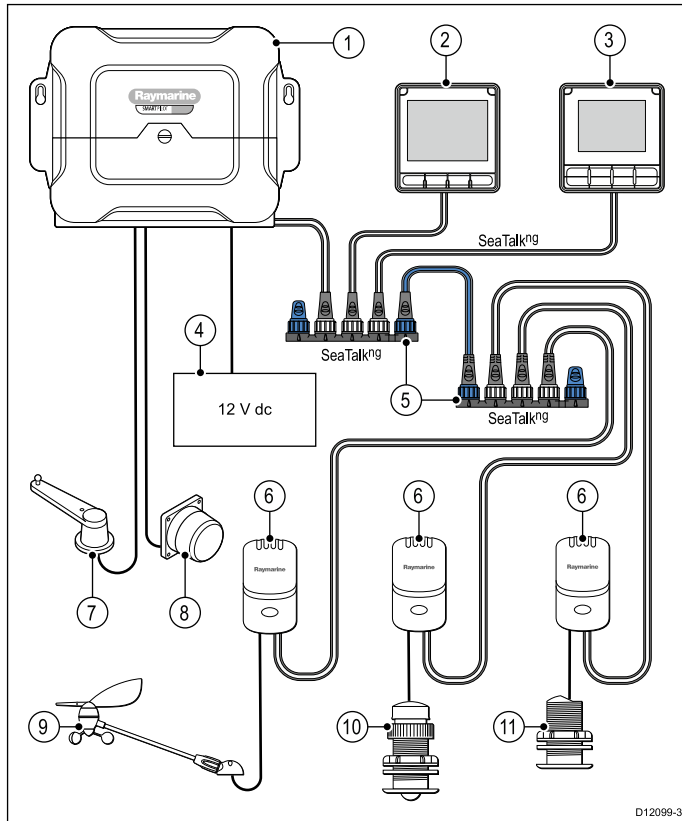

Item	Description
1	SPX (supplying 12 V dc to the SeaTalk^{ng} network.)
2	i70s Multifunction instrument displays
3	p70s / p70Rs Pilot controller (p70s shown)
4	Vessel's 12 V dc power supply
5	SeaTalk^{ng} 5-way connector
6	Transducer pods
7	Rudder reference transducer
8	Fluxgate compass
9	Wind transducer
10	Speed transducer
11	Depth transducer

4.6 SeaTalk connection

Connections to a SeaTalk network are made using a SeaTalk to SeaTalk^{ng} adaptor cable (not supplied).

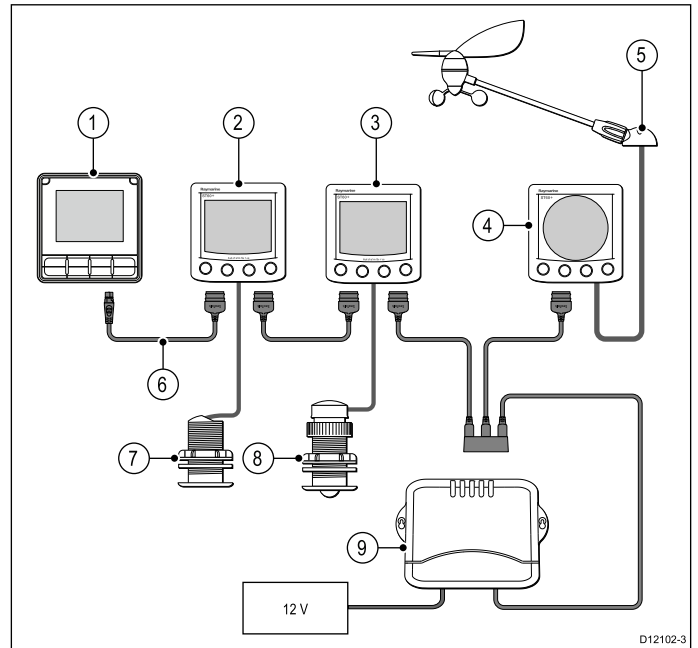

Item	Description
1.	p70s Pilot controller
2.	ST60+ Depth instrument
3.	ST60+ Speed instrument
4.	ST60+ Wind instrument
5.	Wind transducer
6.	SeaTalk to SeaTalk^{ng} adaptor cable
7.	Depth transducer
8.	Speed transducer
9.	Course computer (supplying 12V to SeaTalk network.)

For **SeaTalk** cables and extensions, use **SeaTalk** cable accessories.

SeaTalk power protection

The power supply must be protected by a 5 A fuse or a circuit breaker providing equivalent protection.

Raymarine recommends that the power is connected to a SeaTalk system in such a way that the current drawn on each side of the power connection point is equal.

4.7 NMEA 2000 network connection

Your **SeaTalk^{ng}**® device can be connected to a **DeviceNet / NMEA 2000** network.

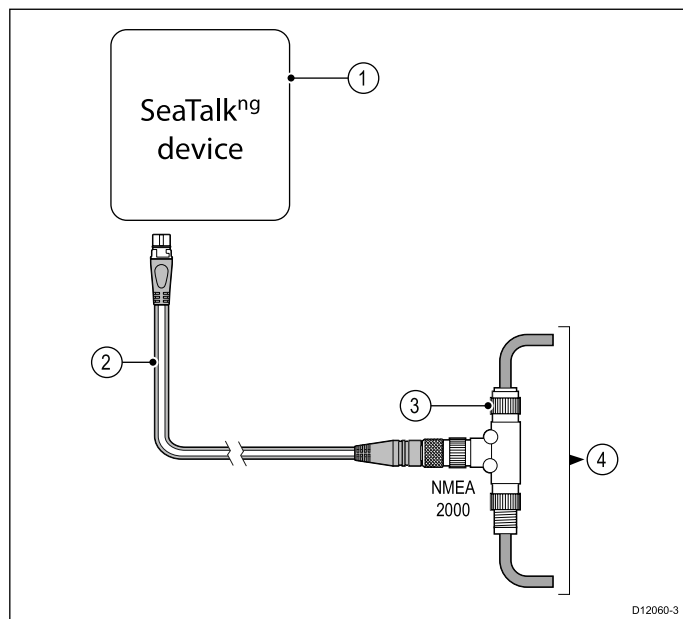

1. **SeaTalk^{ng}**® device
2. **SeaTalk^{ng}**® to **DeviceNet** adaptor cable (A06045)
3. **DeviceNet** T-piece
4. **NMEA 2000** backbone

SVIB

SWIB

Chapter 5: Installation

Chapter contents

- [5.1 Bezel removal on page 30](#)
- [5.2 Removing the keypad on page 30](#)
- [5.3 Mounting on page 31](#)
- [5.4 Refitting the keypad on page 32](#)

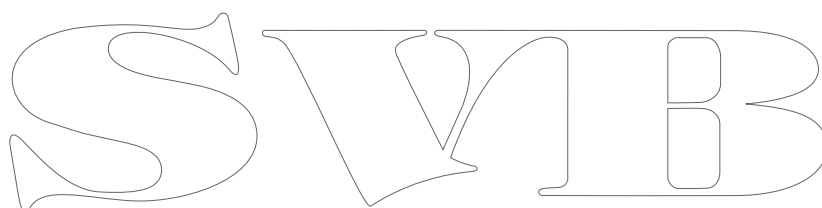

5.1 Bezel removal

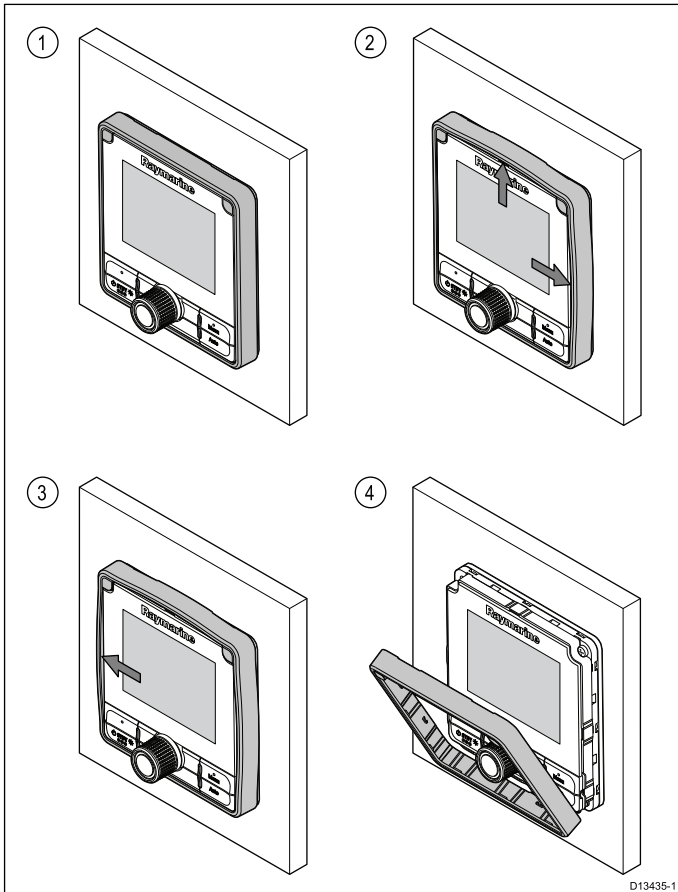

5.2 Removing the keypad

To remove the keypad from the unit follow the steps below.

- **Care Point** — Take care not to bend the keypad as this may prevent the keypad from fitting correctly.

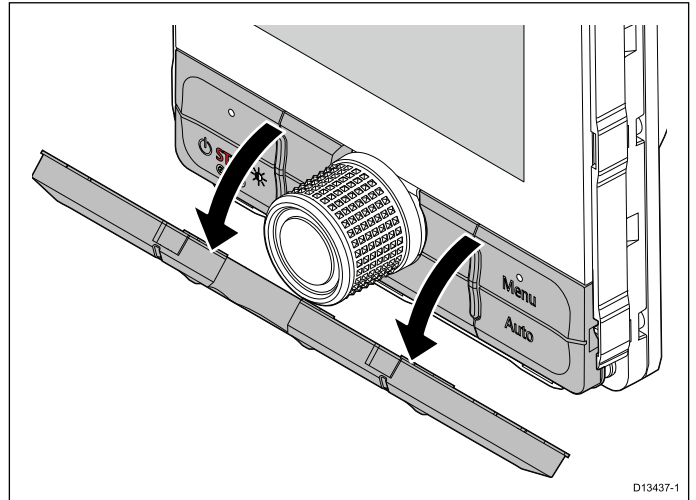

1. Remove the Front bezel.
2. Using your fingers, grip the top edge of the keypad and pull it down and away from the unit.

Removing the bezel

Note: Take care when removing the bezel. Do not use any tools to lever the bezel, doing so may cause damage.

1. Using your fingers pull the bezel away from the unit at the top and on one side.
You should hear a click as each side is released.
2. Now pull the bezel away from the unit on the opposite side.
The bezel can now be pulled away from the unit.

5.3 Mounting

Pre-mounting check

The product is designed to be surface mounted. Before mounting the unit, ensure you have:

- Selected a suitable location.
- Identified the cable connections and route that the cables will take.
- Detached the front bezel.
- Remove the keypad mat.

Mounting diagram

p70s Mounting

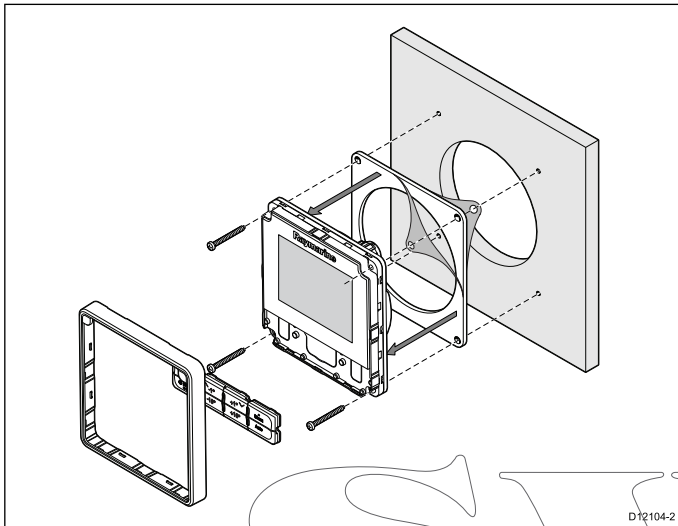

p70Rs Mounting

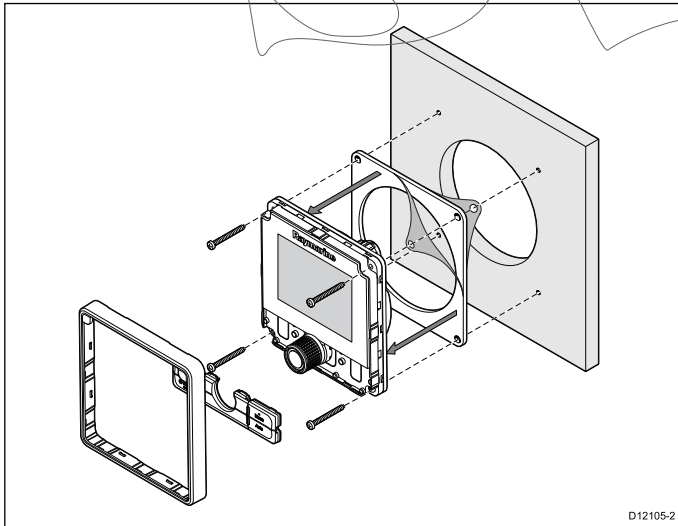

5. Ensure that the unit fits into the removed area and then file around the cut edge until smooth.
6. Drill any required holes as indicated on the mounting template for the mounting fixings.
7. Peel the backing off of the supplied gasket and place the adhesive side of the gasket onto the display unit and press firmly onto the flange.
8. Connect the relevant cables to the unit.
9. Slide the unit into place and secure using the fixings provided.
10. Fit keypad mat and front bezel.

Note: Drill, tap size and tightening torques are dependant upon the material type and thickness of the mounting surface.

Note: The supplied gasket provides a seal between the unit and a suitably flat and stiff mounting surface or binnacle. The gasket should be used in all installations. It may also be necessary to use a marine-grade sealant if the mounting surface or binnacle is not entirely flat and stiff or has a rough surface finish.

Mounting instructions

1. Check the selected location for the unit, a clear, flat area with suitable clearance behind the panel is required.
2. Fix the mounting template supplied with the product, to the selected location, using masking or self adhesive tape.
3. If possible use an appropriate size hole cutter and cut out the centre hole cut out area as indicated on the mounting template, or
4. Using a suitable drill bit, make pilot holes in each corner of the cut out area and using a jigsaw cut along the inside edge of the cut out line.

5.4 Refitting the keypad

The keypad is held in place by tabs, located on the top and bottom edge of the keypad. To refit the keypad correctly all of the tabs must be engaged.

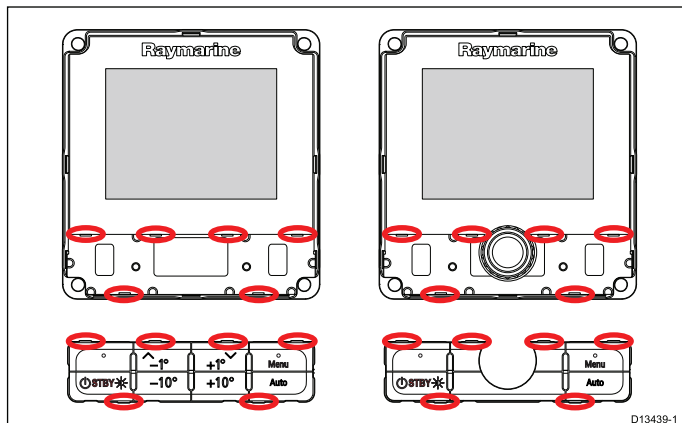

1. Tilt the top edge of the keypad forwards and insert the bottom edge into the unit, ensuring the tabs line up with their respective slots.

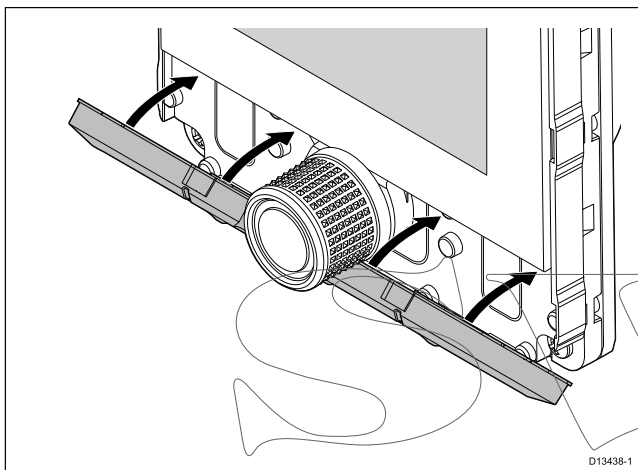

2. Push the top edge of the keypad back and up into the unit.
3. Using your fingers, apply pressure at each tab location, ensuring that the keypad tabs are fully engaged.
4. Refit the bezel.

Chapter 6: Getting started

Chapter contents

- [6.1 Pilot controls on page 34](#)
- [6.2 Before using your product on page 35](#)
- [6.3 Powering the Pilot controller on on page 35](#)
- [6.4 Completing the startup wizard on page 36](#)
- [6.5 Pilot functions on page 36](#)
- [6.6 Display settings on page 37](#)
- [6.7 Multiple data sources \(MDS\) overview on page 38](#)

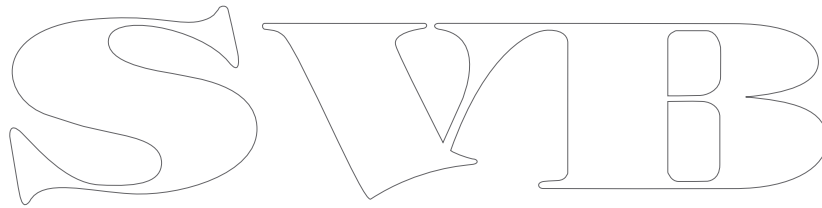

6.1 Pilot controls

p70s – 8 button pilot controller

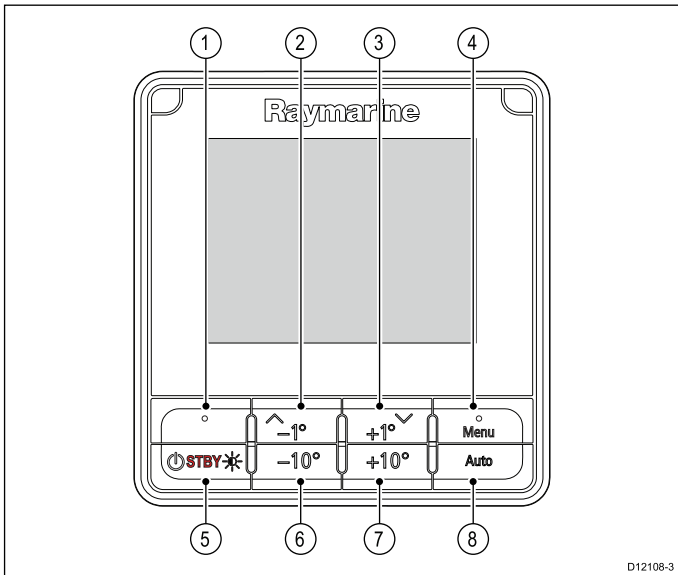

Item	Description
1.	LEFT SOFT BUTTON Cancel, Back, mode selection.
2.	UP BUTTON / -1 Up navigation, Adjust Up, Decrease angle.
3.	DOWN BUTTON / +1 Down navigation, Adjust Down, Increase angle.
4.	RIGHT SOFT BUTTON Menu, Select, OK, Save.
5.	STANDBY BUTTON Disengage pilot, Manual control, Power, Brightness.
6.	-10 BUTTON Decrease angle.
7.	+10 BUTTON Increase angle.
8.	AUTO BUTTON Engage Auto pilot.

Item	Description
1.	LEFT SOFT BUTTON Cancel, Back, mode selection.
2.	STANDBY BUTTON Disengage pilot, Manual control, Power, Brightness.
3.	ROTARY CLOCKWISE Down navigation in list, Adjust Up, Increase angle (locked heading), adjust numerical values, power steer.
4.	ROTARY ANTI-CLOCKWISE Up navigation in list, Adjust Down, Decrease angle (locked heading), adjust numerical values, power steer.
5.	RIGHT SOFT BUTTON Menu, Select, OK, Save.
6.	AUTO BUTTON Engage Auto pilot.
7.	ROTARY END PUSH BUTTON Menu, Select, OK, Save.

The pilot controller supports the following combination button presses:

Combination button press

Buttons	Action
STANDBY and AUTO.	Puts pilot in to Wind Vane mode.
-1 and -10 or +1 and +10.	AutoTack (in wind vane mode), AutoTurn

p70Rs — rotary pilot controller

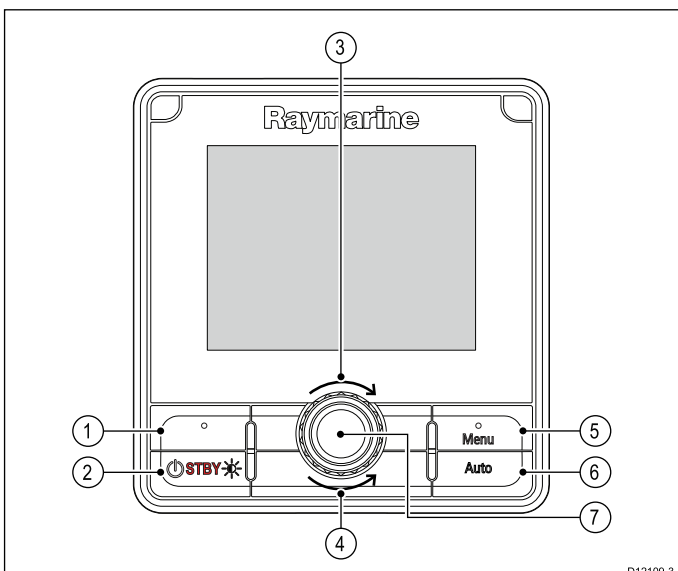

6.2 Before using your product

Commissioning

Before using your autopilot system for the first time you must ensure that the system has been correctly commissioned in accordance with the supplied documentation.

6.3 Powering the Pilot controller on

1. Press and hold the **STANDBY** button for one second, until the logo appears.
If the unit is being switched on for the first time or after a factory reset the set up wizard will be launched.

Note: The logo is not displayed if the unit is in 'sleep mode'. In Sleep mode the unit may appear off but still has power.

2. To turn the Pilot controller off press and hold the **STANDBY** button. After 1 second a pop up count down is displayed.
3. Continue to hold the **STANDBY** button for a further 3 seconds to complete the power off.

Note: You cannot power off the Pilot controller whilst the Autopilot is engaged.

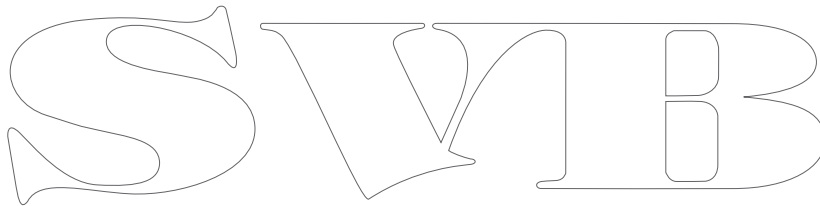

6.4 Completing the startup wizard

When you power-up the unit for the first time or after a system reset the Startup Wizard is displayed.

The setup wizard guides you through the following basic configuration settings:

1. Language
2. Boat Type
3. Welcome



1. Using the **Up** and **Down** buttons, highlight the user interface Language that you want to use and then press the **Menu** button to confirm the selection.
2. Using the **Up** and **Down** buttons, highlight the Boat Type that you want to use and then press the **Menu** button to confirm the selection.
The Welcome page is displayed.
3. Select **Continue**.
The first of a pre-defined set of Favorite pages is displayed.

Note: The Startup Wizard may not be displayed if these settings have already been set on the system that the unit is connected to.

6.5 Pilot functions

The SmartPilot has various modes:

Standby	Manual steering, activated by STANDBY button.
Auto	Autopilot engaged steering to a heading, activated by AUTO button.
Wind vane	Autopilot engaged steering to maintain a selected apparent or true wind angle, activated from the Mode menu, or by pressing AUTO and STANDBY together.
Track	Autopilot engaged steering to a waypoint, activated from the Mode menu.
Pattern	Autopilot engaged in fishing pattern mode, activated from the Mode menu.
Power steer (p70Rs rotary or joystick only)	Autopilot engaged in power steering mode, activated from the Mode menu.
Jog steer	Autopilot disengaged in jog steer mode (tiller drives and SeaTalk only), activated whilst in Standby mode.

6.6 Display settings

Adjusting the unit's brightness

To adjust the unit's LCD brightness level, when it is not part of a Shared Brightness group follow the steps below.

1. Press the **Power** button.
The Display Brightness page is displayed.
2. Use the **Up** and **Down** buttons to adjust the brightness to the required level.
3. Select **Ok**.
The Display Brightness page will time-out after 2 seconds, saving the new brightness level.

Shared Brightness

You can set up Shared Brightness groups which enables simultaneous brightness adjustment the all units that are part of the same group.

The following products are compatible with Shared Brightness:

- **LightHouse™** powered MFDs
- **SeaTalk^{ng}®** Instrument displays and Pilot controllers
- **Ray50 / Ray52 / Ray60 / Ray70** VHF DSC Radios

Any adjustments to the Shared Brightness level will be reflected on all units assigned to the same group.



Multiple brightness groups can be configured. These groups could be used to reflect the physical location of units on your vessel. For example, the units at your helm can be set to one group, and the units on the flybridge can be set to a different group.

Shared Brightness requires:

- all units to be compatible with the Shared Brightness function (see list of compatible units above).
- the **Share brightness** setting set to On for all units in the brightness group.
- units to be assigned to Network Groups.
- all the displays in that group to be synchronized.

Assigning A Network Group

To enable the Shared Brightness and Color, unit's must be assigned to the same network group.

Compatible Instrument Displays and Pilot Controllers will also share their Color Scheme.

From the Network Group menu: (**Menu > Set-up > System Set-up > Network Group**)

1. Select the Network Group that you want to assign the unit to.
A list of network groups will be displayed:
 - None (default)
 - Helm 1
 - Helm 2
 - Cockpit
 - Flybridge
 - Mast
 - Group 1 — Group 5
2. Select **Brightness/Color Group**.
3. Select **This Group**.
4. Select **Sync**.

The System will now synchronize all units assigned to the same group.

5. Select **OK**.
6. Carry out steps 1 to 5 on all unit's.

The location of the Shared Brightness menu on **LightHouse™** MFDs is: (**Homescreen > Customize > Display Preferences > Shared Brightness**)

Adjusting the Brightness level will now effect all units assigned to the same group.

Unsharing a unit

Instrument Displays and Pilot Controllers can be removed from the Shared Brightness.

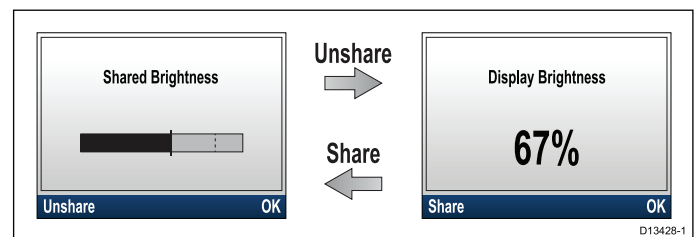

1. Press the **Power** button to display the Shared Brightness page.
2. Select **Unshare**.

Selecting **Share** from the Display Brightness page will switch back to Shared Brightness.

Changing the color scheme

From the colors menu: (**Menu > Display Settings > Colors**)

1. Select a color scheme from the list
 - Day 1
 - Day 2
 - Inverse
 - Red/Black

If the unit is part of a network group, the color scheme selected will change on all units that support color schemes and are part of the same group.

Display response

Setting the Display Response

Setting the Display Response to a low value will dampen data fluctuations to provide a more stable reading. Setting the Display Response to a high value will reduce then damping to make readings more responsive.

From the Display Settings menu: (**Menu > Display Settings**)

1. Select **Display Response**.
2. Select the data type:
 - Speed
 - Depth
 - Wind speed
 - Wind angle
 - Heading
3. Adjust the value as required.
4. Select **Save**.

6.7 Multiple data sources (MDS) overview

When a system includes multiple instances of a data source the preferred data source is selected automatically. The systems preferred source may not be your preferred source, or if you are experiencing a data conflict you can manually select your preferred data source.

MDS enables you to choose a preferred source for the following data types:

- GPS Position
- GPS Datum
- Time & Date
- Heading
- Depth
- Speed
- Wind

This exercise would usually be completed as part of the initial installation, or when new equipment is added.

For MDS to be available all products in the system that use the data sources listed above, must be MDS-compliant. The system will report any products that are NOT MDS-compliant. It may be possible to upgrade the software for these products, to make them compliant. Visit the Raymarine website (www.raymarine.com) to obtain the latest software for your products.

If MDS-compliant software is not available for the product and you do NOT want to use the systems preferred data source, you must remove any non-compliant product from the system. You should then be able to select your preferred data source.

Note: Once you have completed setting up your preferred data sources, you may be able to add the non-compliant products back into the system.

Selecting a preferred data source

From the System Set-up menu: (**Menu > Set-up > System Set-up**)

1. Select **Data Sources**.
2. Select the Data type.

The unit will now search for and display a list of all sources for the selected data type.

Depth	
<input checked="" type="checkbox"/>	Auto
<input type="checkbox"/>	00380016 STng - ACTIVE ST70 Depth Pod
<input type="checkbox"/>	00420065 STng iTC-5 Converter
Back	Select

3. Select your preferred data source, or
4. Select **Auto** to allow the system to decide.

ACTIVE is displayed next to the data source that is the current source for the data type.

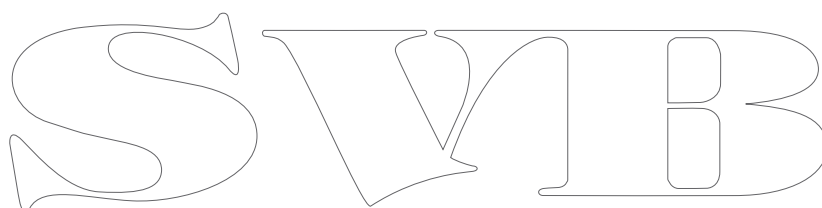
The image shows the letters 'SWIB' in a large, stylized, outlined font. The letters are white with a black outline. The 'S' is a simple, rounded shape. The 'W' is composed of two 'V' shapes joined at the top. The 'I' is a simple vertical bar. The 'B' is a simple, rounded shape with a vertical bar in the middle.

SWIB

Chapter 7: Commissioning - Evolution autopilot system

Chapter contents

- [7.1 Evolution autopilot installation on page 42](#)
- [7.2 Autopilot commissioning — main differences between Evolution and SPX systems on page 42](#)
- [7.3 Autopilot response levels on page 43](#)
- [7.4 Initial setup and commissioning on page 43](#)
- [7.5 Powering the Pilot controller on on page 44](#)
- [7.6 Using the Set-up Wizard on page 45](#)
- [7.7 Using the Dockside wizard on page 45](#)
- [7.8 Adjusting the hard-over time — Evolution on page 47](#)
- [7.9 Compass linearization — Evolution autopilots on page 47](#)
- [7.10 Compass lock on page 49](#)

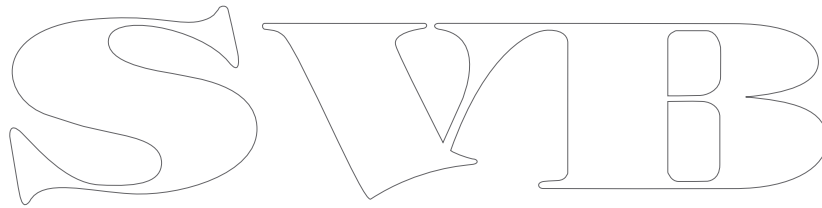

7.1 Evolution autopilot installation

For information on installing and connecting an Evolution autopilot system, refer to the installation instructions that accompany the EV-1 and EV-2 units, as appropriate.

7.2 Autopilot commissioning — main differences between Evolution and SPX systems

The Evolution system provides a number of features to improve upon the commissioning process required by existing SPX and some other autopilot systems.

- **Built-in heading and attitude sensor** — no additional fluxgate compass required.
- **Automatic set-up** — the rudder gain, counter rudder, manual compass calibration and autolearn settings required for existing SPX systems are no longer required. This results in a greatly simplified dockside calibration process for Evolution autopilot systems.

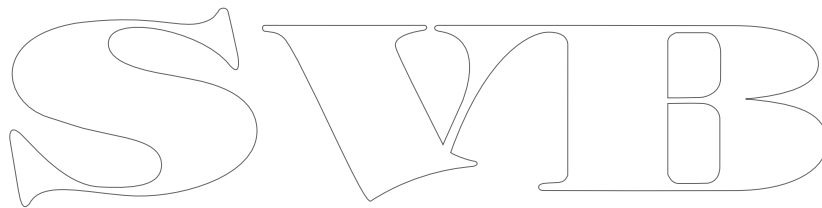
The image shows the letters 'SWIB' in a large, stylized, outlined font. The letters are white with a black outline, set against a plain white background. The font is a classic serif style with decorative flourishes.

7.3 Autopilot response levels

The Evolution autopilot system features a number of different response levels to help you quickly configure the system for optimum performance for the current conditions. In Wind Vane mode, Wind Trim is automatically set by your selected response level.

The available response levels are:

- **Leisure** — suitable for long passages where tight heading control is not critical.
- **Cruising** — good course-keeping without overworking the pilot.
- **Performance** — emphasis on tight heading control.

You can change the response level at any time by selecting **MENU > Response Level**. Then select **Save** to keep the changes.

7.4 Initial setup and commissioning

Commissioning pre-requisites

Before commissioning your system for the first time, check that the following processes have been carried out correctly:

- Autopilot system installation completed in accordance with the Installation instructions.
- SeaTalk^{ng} network installed in accordance with the SeaTalk^{ng} Reference Manual.
- Where fitted, the GPS receiver has been installed and connected in accordance with the associated Installation instructions.

Check also that the commissioning engineer is familiar with the installation and components of the autopilot system including:

- Vessel type.
- Vessel steering system information.
- What the autopilot will be used for.
- System layout: components and connections (you should have a schematic of the vessel's autopilot system).

Initial set-up

Initial set-up involves the following steps:

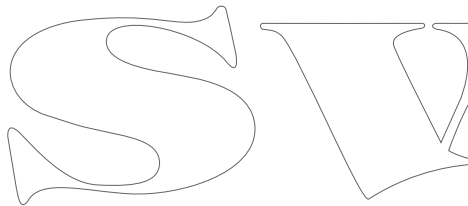

Important: Before proceeding with the initial set-up or commissioning of an Evolution autopilot system with a **p70, p70s, p70R or p70Rs** Pilot Controller, ensure that the Pilot controller, EV and ACU software is updated to the latest versions. Refer to <http://www.raymarine.co.uk/software> to download the latest software and view instructions on how to upgrade the software of your products, using an MFD.

1. Power-up your Pilot Controller.
2. Specify your preferred language and appropriate vessel type, using the **Set-up wizard**.
3. Complete the dockside calibration process, using the **Dockside wizard**:

For vessels without a rudder reference transducer:	For vessels with a rudder reference transducer:
Drive Type selection	Drive Type selection
	Align Rudder (rudder alignment)
Rudder Limit setting	Rudder Limit setting
Hard Over Time (if you do not already know your hard over time, you should skip this step in the Dockside Wizard and enter the value manually afterwards.	
Rudder Drive check	Rudder Drive check

4. Once the dockside wizard is complete, specify the hard-over time (only applies to systems that do NOT include a rudder reference transducer).

5. Familiarize yourself with the important information in this document related to **Compass Linearization**. Follow the guidelines provided to ensure that the process is completed successfully.
6. Once you've successfully completed steps 1 to 5 above, familiarize yourself with the information related to the **Compass Lock**.

7.5 Powering the Pilot controller on

1. Press and hold the **STANDBY** button for one second, until the logo appears.
If the unit is being switched on for the first time or after a factory reset the set up wizard will be launched.

Note: The logo is not displayed if the unit is in 'sleep mode'. In Sleep mode the unit may appear off but still has power.

2. To turn the Pilot controller off press and hold the **STANDBY** button. After 1 second a pop up count down is displayed.
3. Continue to hold the **STANDBY** button for a further 3 seconds to complete the power off.

Note: You cannot power off the Pilot controller whilst the Autopilot is engaged.

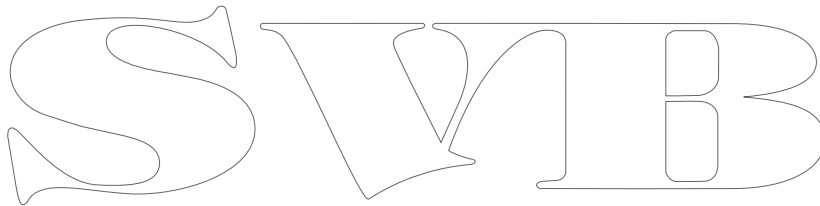

7.6 Using the Set-up Wizard

The set-up wizard guides you through the steps for setting important preferences, such as preferred language and correct vessel type.

The Set-up Wizard contains 3 steps: Language Selection, Vessel Hull Type selection and Welcome Screen. When powering the Pilot Controller for the first time, in an unconfigured system, the Set-up Wizard is displayed automatically, and the first 3 steps listed below will not be required.

With the pilot in **Standby** mode:

1. Select **Menu**.
2. Select **Set-up**.
3. Select **Set-up Wizard**.
4. Select the required language.
5. Select the required vessel type.
The welcome screen will now be displayed and your choices have been saved.
6. Select **OK** to complete the Set-up Wizard.

Vessel hull type selection

The vessel hull type options are designed to provide optimum steering performance for typical vessels.

It is important to complete the vessel hull type selection as part of the initial set-up, as it forms a key part of the autopilot calibration process. You can also access the options at any time with the pilot in Standby by selecting **MENU > Set-up > Autopilot Calibration > Vessel Settings > Vessel Hull Type**.

Select the option that most closely matches your vessel type and steering characteristics. The options are:

- **Power**
- **Power (slow turn)**
- **Power (fast turn)**
- **Sail**
- **Sail (Slow turn)**
- **Sail Catamaran**

It is important to be aware that steering forces (and therefore rate-of-turn) vary significantly depending on the combination of vessel type, steering system, and drive type. Therefore, the available vessel hull type options are provided for guidance only. You may wish to experiment with the different vessel hull type options, as it might be possible to improve the steering performance of your vessel by selecting a different vessel type.

When choosing a suitable vessel type, the emphasis should be on safe and dependable steering response.

7.7 Using the Dockside wizard

The dockside calibration process must be completed before the Evolution autopilot system can be used for the first time. The Dockside wizard guides you through the steps required for dockside calibration.

The Dockside wizard contains different steps depending on whether you have a rudder reference transducer fitted to your vessel:

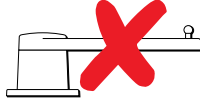
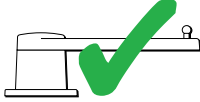
	
<p>The following Dockside wizard procedures only apply to vessels without a rudder reference transducer:</p> <ul style="list-style-type: none"> • Drive Type selection. • Rudder Limit setting. • Hard-over time setting (Raymarine recommends that this information is specified once the dockside wizard and Rudder Drive check is complete, using the Hard Over Time menu option). • Rudder Drive check. 	<p>The following Dockside wizard procedures only apply to vessels with a rudder reference transducer:</p> <ul style="list-style-type: none"> • Drive Type selection. • Align Rudder (rudder alignment). • Rudder Limit setting. • Rudder Drive check.

To access the wizard, ensure the pilot is in **Standby** mode and then:

1. Select **Menu**.
2. Select **Set-up**.
3. Select **Autopilot Calibration**.
4. Select **Commissioning**.
5. Select **Dockside Wizard**.

Selecting a drive type

Drive Type selection is available when the pilot is in standby, from either the Dockside wizard, or from the Vessel setting menu: **MENU > Set-up > Autopilot Calibration > Vessel Settings**.

With the **Drive Type** menu displayed:

1. Select your drive type.

Note: If your drive type is not listed, contact your Raymarine dealer for advice.

Checking the rudder alignment (Align Rudder)

This procedure establishes port and starboard rudder limits for systems using a rudder reference transducer.

The rudder check forms part of the dockside calibration process.

	<p>The following procedure only applies to vessels with a rudder reference transducer.</p>
--	--

1. Center the rudder and select **OK**.

2. When prompted, turn the rudder hard to port and select **OK**.
 3. When prompted, turn the rudder hard to starboard and select **OK**.
 4. When prompted, turn the rudder back to the center and select **OK**.
- Note:** You can cancel Dockside calibration at any time by selecting **STANDBY**.
5. For vessels **without** a rudder reference transducer, you will be asked to confirm that the rudder has turned to port by selecting **YES** or **NO**.
 6. Select **OK** if it is safe to engage the rudder in the opposite direction.
 7. You will be asked to confirm the rudder turned to starboard by selecting **YES** or **NO**.
 8. Dockside calibration is now complete, select **CONTINUE**.

Rudder Limit setting

As part of the Dockside calibration process, the system will set-up the rudder limits.

- **For vessels with a rudder reference transducer** — This procedure establishes the rudder limit. The rudder limit will be displayed with a message confirming that the rudder limit has been updated. This value can be changed if required.
- **For vessels without a rudder reference transducer** — a default of 30 degrees is displayed, and can be changed as required.

Note: If you confirmed a “NO” response for the rudder movement to both port and starboard, the wizard will exit. It is possible that the steering system did not move the rudder in any direction, and it will be necessary to check the steering system before completing the Dockside wizard procedure again.

You can cancel Dockside calibration at any time by pressing **STANDBY**.

Hard over time

The hard over time setting can be specified as part of the Dockside wizard.

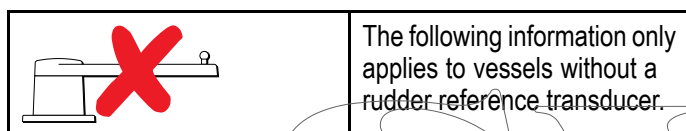

- **If you already know the hard-over time** for your vessel's steering system: enter this time during the Dockside wizard procedure.
- **If you do NOT know the hard-over time** for your vessel's steering system: skip this step during the Dockside wizard procedure by selecting **SAVE**, then proceed to [Checking the rudder drive](#) section in this document to complete the Dockside wizard procedure. Once the wizard is complete, proceed to [8.8 Adjusting the hard-over time — SmartPilot and SPX](#) in this document for information on how to calculate and adjust the hard-over time.

Checking the rudder drive

As part of the dockside calibration process, the system will check the drive connection. Once it has completed the check successfully, a message will appear asking if it is safe for the system to take the helm.

During this procedure the autopilot will move the rudder. Ensure it is safe to proceed before pressing **OK**.

When in dockside calibration mode, with the Motor Check page displayed:

1. Centre and let go of the rudder.
2. Disengage any rudder drive clutch.
3. Select **CONTINUE**.
4. Check it is safe to proceed before selecting **OK**.
For vessels **with** a rudder reference transducer, the autopilot will now automatically move the rudder to port and then starboard.

7.8 Adjusting the hard-over time — Evolution

On vessels without a rudder reference transducer, it is important to set a Hard Over Time.

Before attempting to follow this procedure ensure you have read and understood the Rudder Check warning provided in this document.

To estimate your hard over time follow the steps below:

1. With the autopilot in **Standby**, manually turn the rudder / engine full to port. (For vessels with power steering the engine should be running when turning the rudder.)
2. Engage **Auto** mode.
3. Press the **+10** and **+1** buttons at the same time (p70/p70s) or use the **Rotary** (p70R/p70Rs) to alter your locked heading by 90 degrees. Use a stop watch to time the movement of the rudder / engine.
4. Estimate how long it would take to move the rudder from full port to full starboard. This estimate is your **Hard Over Time**.
5. Enter this estimate as your Hard Over Time. The Hard Over time setting can be accessed from the Drive Settings menu: **Menu > Set-up > Autopilot Calibration > Drive Settings > Hard Over Time**.
6. After setting your Hard Over Time, observe your autopilot's behavior and if required, make small adjustments to the Hard Over Time value until a satisfactory result is achieved.



Warning: Rudder check

If no rudder reference has been fitted you **MUST** ensure that adequate provision is made to prevent the steering mechanism from impacting the end stops.

7.9 Compass linearization — Evolution autopilots

The EV unit's internal compass needs to compensate for local and the Earth's magnetic fields. This is achieved using an automatic process known as linearization.

Initial linearization

When the EV unit is first installed and powered-up (or after a factory reset or compass restart) linearization is required. A progress bar is displayed to indicate linearization is required.

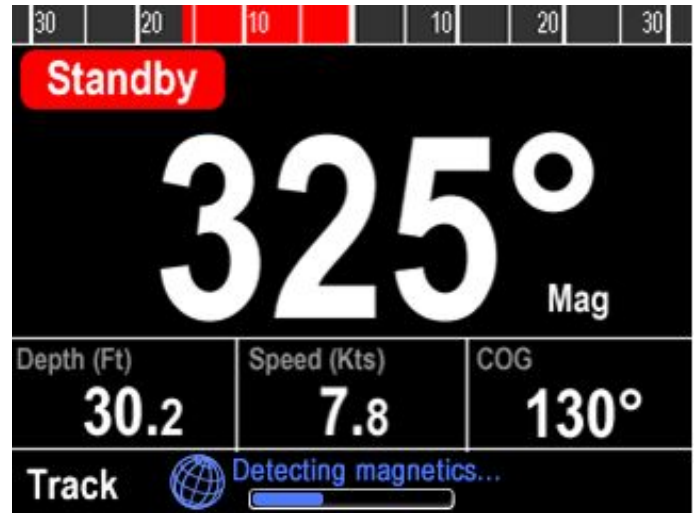

The linearization process will start automatically after your vessel has turned approximately 100° at a speed of between 3 – 15 knots. Linearization requires no user input, however at least a 270° turn is required before linearization can complete. The progress bar will fill to indicate progress, the progress bar will turn Red if the process is paused or otherwise interrupted. Time it takes to complete the linearization will vary according to the characteristics of the vessel, the installation environment of the EV unit, and the levels of magnetic interference at the time of conducting the process. Sources of significant magnetic interference may increase the time required to complete the linearization process. Examples of such sources include:

- Marine pontoons
- Metal-hulled vessels
- Underwater cables

You can speed-up the linearization process by completing a full 360° turn (at a speed of 3 – 15 knots). You can also restart the linearization process at any time by selecting the **Restart Compass** menu item.

Once the initial linearization is completed the Deviation page is displayed and the current maximum compass deviation is shown.

Evolution autopilot has successfully detected and compensated for local & Earth's magnetic fields.



Max deviation:

6.4

Linearisation will continue in the background...

OK

2. Select **Set-up**.
3. Select **Diagnostics**.
4. Select **About Pilot**.

The details related to the pilot diagnostics are displayed.

5. Scroll down to the bottom of the list to view the entry for **Deviation**.

Note: If “-” is displayed as the Deviation value, it means that linearization has not been successfully completed yet.

Adjusting the Compass Offset

With the pilot in Standby:

1. From the **Vessel Settings** menu: (**Menu > Set-up > Autopilot Calibration > Vessel Settings**).
2. Select **Compass Offset**.
3. Use the **+/- 10** button (p70/p70s) or **ROTARY** control (p70R/p70Rs) to adjust the compass offset as appropriate.

The **Compass Offset** can be adjusted between -10° and $+10^{\circ}$.

Compass deviation

If the reported deviation is 45° or higher, it is highly recommended that the EV unit is moved and re-installed in a location which is subject to less magnetic interference. After the linearization process has successfully completed you can check the current deviation value at anytime from the diagnostics pages.

Note: If “-” is displayed as the Deviation value, it means that linearization has not been successfully completed yet.

Check the compass heading data

As part of the autopilot system commissioning process, it is recommended that you check the compass heading value displayed, against a good known heading source on various headings.

Note: Once the linearization process has completed, it is possible that the heading value may have a slight offset of 2 to 3 degrees. This is common where installation space is limited, and the EV unit cannot be properly aligned to the vessel's longitudinal axis. In this case, it is possible to manually adjust the Compass Offset value.

Note: Do NOT rely on the reported heading until compass linearization and alignment is complete.

System monitoring and adaptation

To ensure optimum performance, after the initial linearization process is complete the EV continues to monitor and adapt the compass linearization to suit current conditions.

If the conditions for linearization are less than ideal, the automatic linearization process temporarily pauses until conditions improve again. The following conditions can cause the linearization process to temporarily pause:

- Boat speed < 3 knots.
- Boat speed > 15 knots.
- Rate-of-turn is too slow.
- Significant magnetic interference is present

Accessing the compass deviation indicator

1. Select **MENU**.

7.10 Compass lock

Once you are satisfied with the compass accuracy, you can lock the setting to prevent the autopilot system from completing a further automatic linearization in the future.

This feature is particularly useful for vessels in environments that are exposed to strong magnetic disturbances on a regular basis (such as offshore wind farms or very busy rivers, for example). In these situations it may be desirable to use the Compass lock feature to disable the continuous linearization process, as the magnetic interference may build a heading error over time.

Note: The compass lock may be released at any time, to allow the compass continuous linearization to restart. This is particularly useful if planning a long voyage. The earth's magnetic field will change significantly from one geographical location to another, and the compass can continuously compensate for the changes, ensuring you maintain accurate heading data throughout the voyage.

Locking the compass

Follow the steps below to lock the compass linearization.

From the Commissioning menu: (**Menu > Set-up > Autopilot Calibration > Commissioning**)

1. Select **Compass Lock**.
2. Select **On**.

The compass linearization is now locked.

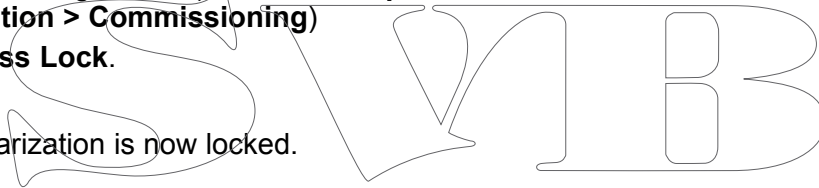

SWIB

Chapter 8: Commissioning - SPX and SmartPilot systems

Chapter contents

- [8.1 SPX and SmartPilot autopilot installation on page 52](#)
- [8.2 Pilot response on page 52](#)
- [8.3 Initial setup and commissioning on page 53](#)
- [8.4 Powering the Pilot controller on on page 53](#)
- [8.5 Using the Set-up Wizard on page 54](#)
- [8.6 Dockside calibration on page 55](#)
- [8.7 Dealer settings on page 56](#)
- [8.8 Adjusting the hard-over time — SmartPilot and SPX on page 57](#)
- [8.9 Sea trial calibration on page 57](#)
- [8.10 Checking autopilot operation on page 59](#)

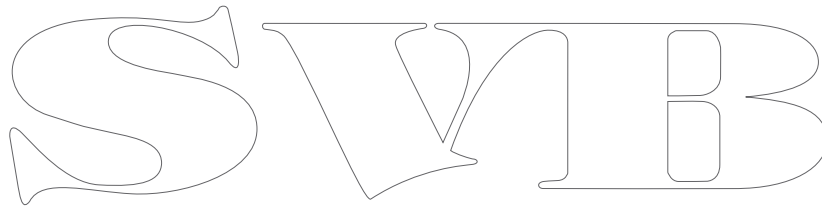

8.1 SPX and SmartPilot autopilot installation

For information on installing and connecting an SeaTalk^{ng} SPX autopilot system or a SeaTalk SmartPilot autopilot system, refer to the installation instructions that accompanied your course computer.

8.2 Pilot response

The response level controls the relationship between course keeping accuracy and the amount of helm/drive activity. Range is from 1 to 9.

Making temporary changes to pilot response

Pilot response is set up during commissioning of the SmartPilot system however you can make temporary changes to the pilot response at any time by accessing the **Pilot response** menu from; **Main menu > Pilot Response**

1. From the Main menu highlight **Pilot response** and press **SELECT**.
2. Use the **UP** and **DOWN** buttons to change the response value to the required setting.
3. Press **SAVE** to save the response value.

Setting	Options
Levels 1 to 3	Minimize the amount of pilot activity. This conserves power, but may compromise short-term course-keeping accuracy.
Levels 4 to 6	Should give good course keeping with crisp, well controlled turns under normal operating conditions.
Levels 7 to 9	Gives the tightest course keeping and greatest rudder activity (and power consumption). This can lead to a rough passage in open waters as the SPX system may 'fight' the sea.

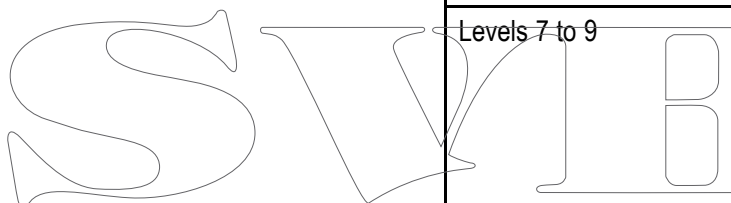

8.3 Initial setup and commissioning

Commissioning pre-requisites

Before commissioning your system for the first time, check that the following processes have been carried out correctly:

- Autopilot system installation completed in accordance with the Installation instructions.
- SeaTalk^{ng} network installed in accordance with the SeaTalk^{ng} Reference Manual.
- Where fitted, the GPS receiver has been installed and connected in accordance with the associated Installation instructions.

Check also that the commissioning engineer is familiar with the installation and components of the autopilot system including:

- Vessel type.
- Vessel steering system information.
- What the autopilot will be used for.
- System layout: components and connections (you should have a schematic of the vessel's autopilot system).

Commissioning process

- Check you have adhered to commissioning pre-requisites
- Initial power on and set-up
- Dockside calibration (Dealer Settings on SeaTalk systems)
- Set hard over time (non-rudder reference systems only)
- Sea trial calibration
- System checks

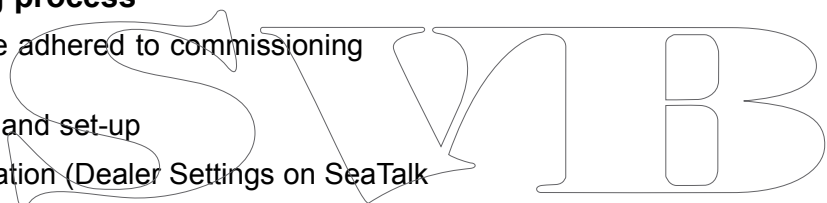

8.4 Powering the Pilot controller on

1. Press and hold the **STANDBY** button for one second, until the logo appears.
If the unit is being switched on for the first time or after a factory reset the set up wizard will be launched.

Note: The logo is not displayed if the unit is in 'sleep mode'. In Sleep mode the unit may appear off but still has power.

2. To turn the Pilot controller off press and hold the **STANDBY** button. After 1 second a pop up count down is displayed.
3. Continue to hold the **STANDBY** button for a further 3 seconds to complete the power off.

Note: You cannot power off the Pilot controller whilst the Autopilot is engaged.

8.5 Using the Set-up Wizard

The set-up wizard guides you through the steps for setting important preferences, such as preferred language and correct vessel type.

The Set-up Wizard contains 3 steps: Language Selection, Vessel Hull Type selection and Welcome Screen. When powering the Pilot Controller for the first time, in an unconfigured system, the Set-up Wizard is displayed automatically, and the first 3 steps listed below will not be required.

With the pilot in **Standby** mode:

1. Select **Menu**.
2. Select **Set-up**.
3. Select **Set-up Wizard**.
4. Select the required language.
5. Select the required vessel type.
The welcome screen will now be displayed and your choices have been saved.
6. Select **OK** to complete the Set-up Wizard.

Vessel hull type selection

The vessel hull type options are designed to provide optimum steering performance for typical vessels.

It is important to complete the vessel hull type selection as part of the initial set-up wizard, as it forms a key part of the autopilot calibration process.

You can also access the options at any time with the pilot in Standby by selecting **MENU > Set-up > Autopilot Calibration > Vessel Settings > Vessel Hull Type**.

As a general guide, select the option that most closely matches your vessel type and steering characteristics. The options are:

- **Race Sail.**
- **Sail Cruiser.**
- **Catamaran.**
- **Workboat.**
- **RIB.**
- **Outboard Speedboat**
- **Inboard Speedboat**
- **Power Cruiser 1 (<12 kts)**
- **Power Cruiser 2 (<30 kts)**
- **Power Cruiser 3 (>30 kts)**
- **Sport Fishing**
- **Pro Fishing**

It is important to be aware that steering forces (and therefore rate-of-turn) vary significantly depending on the combination of vessel type, steering system, and drive type. Therefore, the available vessel hull type options are provided for guidance only. You may wish to experiment with the different vessel hull type options, as it might be possible to improve the steering performance of your vessel by selecting a different vessel type.

When choosing a suitable vessel type, the emphasis should be on safe and dependable steering response.

Important: If you change the vessel type **after** completing the Dockside calibration process (using the Dockside wizard), all commissioning settings will be reset to default settings, and you will need to complete the Dockside calibration process again.

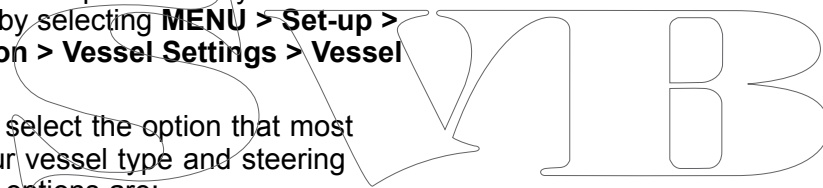

8.6 Dockside calibration

The dockside calibration process must be completed before your SPX autopilot system can be used for the first time. The Dockside wizard guides you through the steps required for dockside calibration.

The Dockside wizard contains different steps depending on whether you have a rudder reference transducer fitted to your vessel:

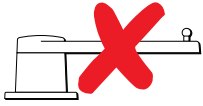
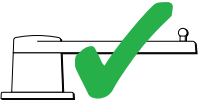
	
<p>The following Dockside wizard procedures only apply to vessels without a rudder reference transducer:</p> <ul style="list-style-type: none"> • Drive Type selection. • Rudder Limit setting. • Rudder Drive check. 	<p>The following Dockside wizard procedures only apply to vessels with a rudder reference transducer:</p> <ul style="list-style-type: none"> • Drive Type selection. • Align Rudder (rudder alignment). • Rudder Limit setting. • Rudder Drive check.

On older SeaTalk SmartPilot systems the Dockside wizard is named Dealer Settings. Please refer to [8.7 Dealer settings](#) for calibration details.

Using the Dockside wizard

To access the dockside wizard follow the steps below:

Ensure the pilot is in **Standby**.

1. Select **Menu**.
2. Select **Set-up**.
3. Select **Autopilot Calibration**.
4. Select **Commissioning**.
5. Select **Dockside Wizard**.
6. Follow the on-screen instructions.

Note: You can cancel the Dockside wizard at any time by pressing the **Standby** button.

Selecting a drive type

Drive Type selection is available when the pilot is in standby, from either the Dockside wizard, or from the Vessel setting menu: **MENU > Set-up > Autopilot Calibration > Vessel Settings** .

With the **Drive Type** menu displayed:

1. Select your drive type.

Note: If your drive type is not listed, contact your Raymarine dealer for advice.

Checking the rudder alignment (Align Rudder)

This procedure establishes port and starboard rudder limits for systems using a rudder reference transducer.

The rudder check forms part of the dockside calibration process.

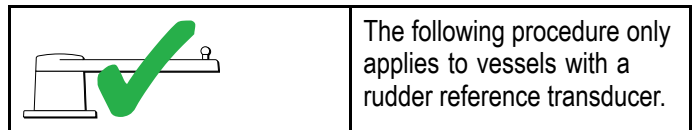

1. Center the rudder and select **OK**.
2. When prompted, turn the rudder hard to port and select **OK**.
3. When prompted, turn the rudder hard to starboard and select **OK**.
4. When prompted, turn the rudder back to the center and select **OK**.

Note: You can cancel Dockside calibration at any time by selecting **STANDBY**.

Rudder Limit setting

As part of the Dockside calibration process, the system will set-up the rudder limits.

- **For vessels with a rudder reference transducer** — This procedure establishes the rudder limit. The rudder limit will be displayed with a message confirming that the rudder limit has been updated. This value can be changed if required.
- **For vessels without a rudder reference transducer** — a default of 30 degrees is displayed, and can be changed as required.

Checking the rudder drive

As part of the dockside calibration process, the system will check the drive connection. Once it has completed the check successfully, a message will appear asking if it is safe for the system to take the helm.

During this procedure the autopilot will move the rudder. Ensure it is safe to proceed before pressing OK.

When in dockside calibration mode, with the Motor Check page displayed:

1. Centre and let go of the rudder.
2. Disengage any rudder drive clutch.
3. Select **CONTINUE**.
4. Check it is safe to proceed before selecting **OK**.
For vessels **with** a rudder reference transducer, the autopilot will now automatically move the rudder to port and then starboard.
5. For vessels **without** a rudder reference transducer, you will be asked to confirm that the rudder has turned to port by selecting **YES** or **NO**.
6. Select **OK** if it is safe to engage the rudder in the opposite direction.
7. You will be asked to confirm the rudder turned to starboard by selecting **YES** or **NO**.
8. Dockside calibration is now complete, select **CONTINUE**.

Note: If you confirmed a “NO” response for the rudder movement to both port and starboard, the wizard will exit. It is possible that the steering system did not move the rudder in any direction, and it will be necessary to check the steering system before completing the Dockside wizard procedure again.

You can cancel Dockside calibration at any time by pressing **STANDBY**.

8.7 Dealer settings

The dockside calibration wizard is only available on a SeaTalk^{ng} system, for SeaTalk systems the **Dealer settings** should be set before going out on the sea.

The dealer settings menu can be accessed from: **Main menu > Set up > Auto pilot calibration > Dealer settings**. Once entered the dealer settings menu will cycle through all available options.

Options and limits are dependent on the course computer installed.

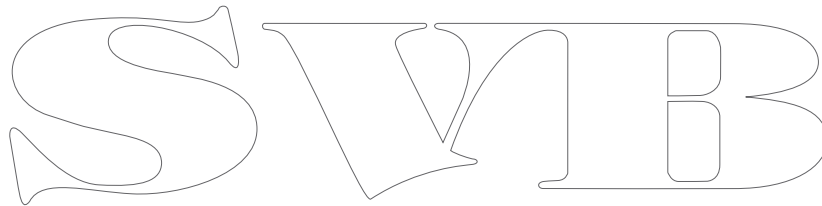
A large, stylized outline logo consisting of the letters 'S', 'W', and 'B' in a decorative, serif font. The 'S' is on the left, 'W' is in the middle, and 'B' is on the right. The letters are connected at the top and bottom, forming a continuous shape.

8.8 Adjusting the hard-over time — SmartPilot and SPX

On vessels without a rudder reference transducer, it is important to set a Hard Over Time.

Before attempting to follow this procedure ensure you have read and understood the Rudder Check warning provided in this document.

To estimate your hard over time follow the steps below:

1. Adjust your Rudder Gain setting to the maximum value, making a note of the original value. The Rudder Gain setting can be accessed from the Drive Setting menu: **Menu > Set-up > Autopilot Calibration > Drive Settings > Rudder Gain.**
2. With the autopilot in **Standby**, manually turn the rudder / engine full to port. (For vessels with power steering the engine should be running when turning the rudder.)
3. Engage **Auto** mode.
4. Press the **+10** and **+1** buttons at the same time (p70/p70s) or use the **Rotary** (p70R/p70Rs) to alter your locked heading by 90 degrees, use a stop watch to time the movement of the rudder / engine.
5. Estimate how long it would take to move the rudder from full port to full starboard. This estimate is your **Hard Over Time.**
6. Enter this estimate as your Hard Over Time. The Hard Over time setting can be accessed from the Drive Settings menu: **Menu > Set-up > Autopilot Calibration > Drive Settings > Hard Over Time.**
7. Change your Rudder Gain back to its original value.
8. After setting your Hard Over Time, observe your autopilot's behavior and if required, make small adjustments to the Hard Over Time value until a satisfactory result it achieved.



Warning: Rudder check

If no rudder reference has been fitted you **MUST** ensure that adequate provision is made to prevent the steering mechanism from impacting the end stops.

8.9 Sea trial calibration

Before you can use the autopilot open water checks are required. The water must be calm, with light or no wind. Leave plenty of room to manoeuvre. The Sea Trial wizard guides you through the steps required for Sea trial calibration.

The Sea trial wizard includes the following steps:

- Swing compass
- Align compass to GPS
- Align compass manually
- Auto Learn.

You can access the Sea trial wizard at any time from the Commissioning menu: **Menu > Set-up > Autopilot calibration > Commissioning.**

Note: Sailing vessels should perform the sea trial under engine power.

Note: The Sea trial wizard can be cancelled at any time by pressing the **Standby** button.



Warning: Seatrial calibration

Ensure you have sufficient sea room for calibration. The seatrial calibration maneuvers require a clear, familiar area of water. Ensure you are not likely to collide with any vessel or other obstruction during calibration.



Warning: Maintain sensible speeds

The autopilot may make unexpected turns.

Compass swing

You will need to turn your vessel in slow circles while the system automatically makes adjustments to account for compass deviation. Each 360-degree circle should take no less than two minutes, and you should complete at least two circles.

1. Start moving vessel in slow even circles, then press **START**.
2. Keep speed to below 2 knots. Watch the display to ensure your turn rate is not too fast. If the message 'Slow Down' is displayed reduce your rate of turn, this can be achieved by slowing down and / or steering in a wider circle.
If a 'Slow Down' message is displayed the current circle will have to be repeated.
3. When the compass has been calibrated, a message will be displayed showing the detected deviation. If this is more than 15 degrees you will need to abort the calibration process and resite the compass further away from metal items, then repeat the calibration process. If you still find a deviation of more than 15 degrees, contact your Raymarine dealer for advice. If the deviation is within acceptable limits, press **CONTINUE**.

You can cancel Seatrial calibration at any time by pressing **STANDBY**.

Aligning compass to GPS

Note: Systems without a GPS will skip this section and go straight to Manual compass alignment.

If your system has a GPS connected to your data network (SeaTalk, SeaTalk^{ng} or NMEA), the autopilot is tuned to the GPS heading while you steer to a known magnetic heading. This step provides a rough alignment and minimizes the amount of compass fine tuning required.

1. Steer the vessel on a steady course with minimal tide, increase speed to more than 3 knots and press **START** to align the compass to GPS.
2. Follow the on-screen instructions until the process completes, press the **CONTINUE** button when it is available to begin autolearn.

You can cancel Seatrial calibration at any time by pressing **STANDBY**.

Aligning compass manually

Where no GPS is present manual alignment of the compass is required.

1. Continue to steer on a steady course and use the Use **+1** and **-1** buttons, or the **ROTARY** controller to adjust the heading displayed until it matches the vessel's compass reading.
2. When complete press **CONTINUE** to begin **Autolearn**.

Auto Learn

You must have significant clear water in front of the vessel to accommodate a series of maneuvers, which include sudden, sharp turns. There should be a clear area at least 100m wide and 500m ahead.

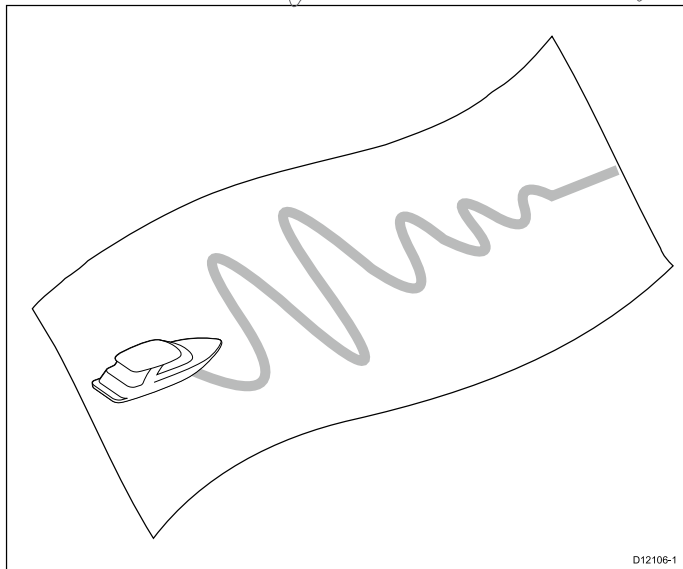

Caution: Autolearn

Please ensure sufficient free space ahead. (Minimum 100x500m long & significantly more for a high speed vessel.)

Performing Auto learn

Auto learn is available from the Sea trial wizard, or from the **Commissioning menu**.

Maintain a normal cruising speed (at least 3 kts) throughout the auto learn process.

1. Ensure there is sufficient free water in front of the vessel and select **continue**.

A warning message is displayed.

2. Select **Continue** or press the **Ok** button.

A warning message will be displayed letting you know that the vessel will zigzag and make Sudden SHARP TURNS.

3. Remove your hands from the wheel and press **Auto** to begin.

During this procedure the autopilot will progress through the required steps.

4. If 'PASS' is displayed then select **Continue** or press the **Ok** button to return to manual helm control.

The autopilot will be placed in Standby mode. You have successfully completed the commissioning process for your SmartPilot system.

5. If 'FAIL' is displayed after completion of the Auto learn process then select **Continue** or press the **Ok** button.

The Auto learn retry message is displayed.

6. You can retry the Auto learn process by selecting **Yes** or to cancel select **No**.

Note: The Sea trial wizard can be cancelled at any time by pressing the **Standby** button.

Caution: System changes

Any additional changes you make to your system settings may require you to repeat the calibration process.

8.10 Checking autopilot operation

After completing calibration, check the basic autopilot operation, as follows:

1. Steer onto a compass heading and hold a steady course at normal cruising speed. If necessary, steer the vessel manually for a short time to check how the vessel steers.
2. Ensure it is safe to engage the autopilot, then press **AUTO** to lock onto the current heading. The autopilot should hold a constant heading in calm sea conditions.
3. Use **-1**, **+1**, **-10** and **+10** or the **ROTARY** controller, to see how the SmartPilot alters the course to port and starboard.
4. Press **STANDBY** to return to manual steering.

Checking rudder gain

To determine whether the rudder gain is set correctly, carry out the following test:

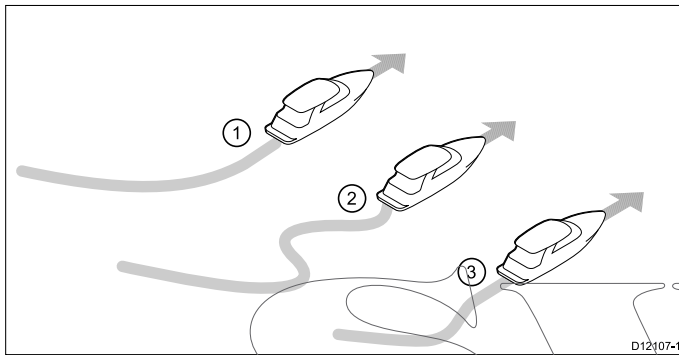

Item	Description
1.	Rudder gain too low
2.	Rudder gain too High
3.	Correct rudder gain

1. Ensure you have set the autopilot response to level 5.
 2. Drive your vessel at a typical cruising speed in clear water.
It is easier to recognize the steering response in calm sea conditions where wave action does not mask steering performance.
 3. Press **AUTO** to enter Auto mode, then alter course by 40°:
 - This course change should result in a crisp turn followed by an overshoot of no more than 5°, If the rudder gain is adjusted correctly.
 - If the course change causes a distinct overshoot (more than 5°) and/or there is a distinct 'S' in the course the rudder gain is too high.
 - If the vessel's performance is sluggish and it takes a long time to make the 40° turn, with no overshoot the rudder gain is too low.
- If necessary, adjust the rudder gain.

Checking counter rudder

Counter rudder is the amount of rudder your autopilot applies to try to prevent your vessel from over steering. A higher counter rudder setting results in more rudder being applied.

To check the counter rudder setting:

1. Ensure you have set the autopilot response to level 5.
2. Drive your vessel at a typical cruising speed in clear water.
3. Press **AUTO** and if necessary engage the autopilot.
4. Make a 90° course change:
 - When rudder gain and counter rudder are both set correctly, the vessel performs a smooth continuous turn with minimal overshoot.
 - If the counter rudder is too low, the vessel will overshoot before returning slowly to the course.
 - If counter rudder is too high, the vessel will 'fight' the turn and make a series of short, sharp turns. This results in a very 'mechanical' feel as the vessel changes course.
5. If necessary, adjust the counter rudder setting.

Counter Rudder is available from the **Drive Settings** menu: **Menu > Set-up > Autopilot Calibration > Drive Settings > Counter Rudder.**

Rudder Damping

If the autopilot is 'hunting' (i.e. continuously moving the steering backwards and forwards by small amounts) when trying to position the rudder, the rudder damping setting will require adjustment to minimize this.

Increasing the rudder damping value reduces hunting. The rudder damping value should be increased 1 level at a time until the autopilot stops hunting. Always ensure the lowest acceptable value is used.

If required the Rudder Damping setting can be adjusted from the Drive Settings menu: **Menu > Set-up > Autopilot Calibration > Drive Settings > Rudder Damping.**

AutoTrim settings

AutoTrim determines how quickly the autopilot applies 'standing helm' to correct for trim changes, caused, for example, by changes in the wind load on the superstructure, or an imbalance of engines. Increasing the AutoTrim level reduces the time the autopilot takes to return to the correct course, but makes the vessel less stable. If the autopilot:

- Gives unstable course keeping and the vessel 'snakes' around the desired course, decrease the AutoTrim level.
- Hangs off course for excessive periods of time, increase the AutoTrim level.

SWIB

Chapter 9: Pilot modes

Chapter contents

- [9.1 Auto on page 62](#)
- [9.2 Mode menu on page 63](#)
- [9.3 Patterns on page 63](#)
- [9.4 Track mode on page 64](#)
- [9.5 Wind vane mode \(Sailing boats only\) on page 66](#)
- [9.6 Power steer on page 68](#)
- [9.7 Jog steer \(tiller pilots only\) on page 69](#)
- [9.8 Shortcut key on page 69](#)

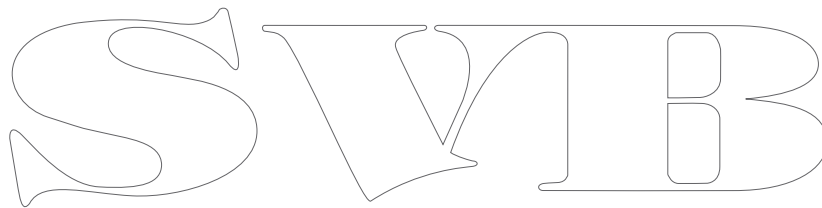

9.1 Auto

Caution: Maintain a permanent watch

Automatic course control makes it easier to steer your vessel, but it is NOT a substitute for good seamanship. ALWAYS maintain a permanent watch by the helm.

Automatically steering to a heading

1. Steady the vessel on the required heading.
2. For Wheel and Tiller drive systems see below instructions for engaging the autopilot.
 - **Wheel Pilot:** Engage the wheel drive clutch by rotating the clutch lever clockwise (so the lever fully engages onto the locating pip).
 - **Tiller Pilot:** Place the pushrod end over the tiller pin. If necessary, extend or retract the pushrod using the **-1, +1, -10,+10** buttons or the **Rotary** control.

Attention Always reach around (not through) the wheel to operate the clutch lever.

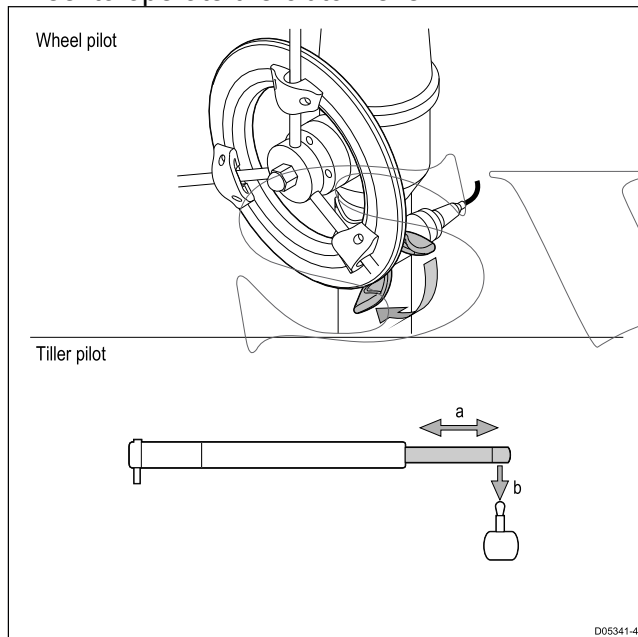

3. Press **AUTO**.

The autopilot is now in AUTO mode and will steer to the chosen locked heading.

Changing course in auto mode

To change course whilst in AUTO mode:

1. Use the **-1** and **-10** button, or turn the rotary controller anticlockwise to change the vessel's course to port.

Pressing **-1** button will increment the course to port by 1° and **-10** will increment by 10°.

Turning the rotary controller 1 click anticlockwise will increment the course to port by 1°.
2. Use the **+1** and **+10** buttons, or turn the rotary controller clockwise to change the vessel's course to starboard.

Pressing **+1** button will increment the course to starboard by 1° and **+10** will increment by 10°.

Turning the rotary controller 1 click clockwise will increment the course to Starboard by 1°.

e.g. pressing the **-1** button four times, or turning the rotary 4 clicks anticlockwise will result in a 4° course change to port.

Disengaging the autopilot (Standby mode)

The autopilot can be disengaged by following the steps below.

1. Press **Standby**.
2. For Wheel and Tiller drive systems see below instructions for disengaging the autopilot to return to manual steering
 - **Wheel Pilot:** Disengage the wheel drive clutch by rotating the clutch lever anti-clockwise (so the lever disengages fully from the locating pip).
 - **Tiller Pilot:** Remove the drive unit from the tiller pin. If necessary, extend or retract the pushrod using the **-1, +1, -10,+10** buttons or the **Rotary** control.

On wheel drive systems, always make sure that the clutch is fully disengaged before you leave the vessel.

9.2 Mode menu

Pilot modes are accessed from the Mode menu. The available modes are determined by the autopilot system and the selected Vessel Hull Type.

The modes available are shown below.

	Evolution	SPX SmartPilot
Pattern	Power vessel	Motor and Fishing vessels
Track	all	all
Wind vane ⁽²⁾	Sailing vessel only	Sailing vessel only
Power Steer ⁽¹⁾	p70Rs and joystick only	p70Rs and joystick only

Note:





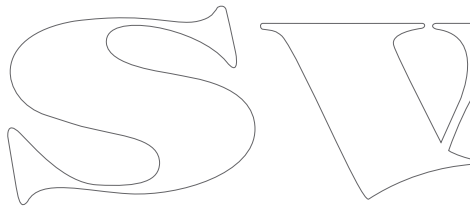



- ⁽¹⁾ Power steer mode is only available on vessels fitted with a rudder reference transducer.
- ⁽²⁾ Wind vane mode is only available if there is a connect source of wind data.

The mode menu also provides a shortcut key option that enables a mode to be assigned to the **Left Soft** button (The default option is Track).



9.3 Patterns

Fishing patterns are available, that can be used with their default settings or adjusted to your own preference. Fishing patterns require GPS data to be available on your system.

Pattern	Adjustment	Icon
Circle	Direction	
	Radius	
Zig Zag	Direction	
	Angle	
	Length	
Cloverleaf	Direction	
	Radius	
Spiral	Direction	
	Radius	
	Increment	
Circle against	Direction	
	Radius	
	Distance	
Figure 8	Direction	
	Radius	
Pattern search	Direction	
	Width	
	Height	
	Width increment	
	Height increment	
180 turn	Direction	
	Radius	
Box search	Direction	
	Width	
	Height	

Using a fishing pattern

1. Press the **RIGHT SOFT** button to open the menu.
2. Using the **UP** and **DOWN** buttons highlight **Mode** and press **SELECT**.
3. Using the **UP** and **DOWN** buttons highlight **Pattern** and press **SELECT**.
4. Using the **UP** and **DOWN** buttons highlight the fishing pattern you wish you use and press **SELECT**.
5. The pattern settings screen shall be displayed, showing the parameters currently set for the selected pattern. If you want to change any of the parameters:
 - i. Select the parameter you want to change, then press **EDIT**.
 - ii. Use the **UP** and **DOWN** buttons to set the value you want, then press **SAVE** to save

the setting and return to the Pattern settings screen.

- iii. Repeat steps i and ii as necessary, for the other parameters.
6. Where appropriate, engage the wheel pilot clutch or attached the tiller pushrod.
7. With the pattern settings screen displayed, press **AUTO**. The autopilot then steers the boat over the fishing pattern you selected.

To return to manual steering at any time, press **STANDBY** and then, where appropriate, disengage the wheel pilot clutch or tiller pushrod.

The 2 most commonly used fishing patterns are available from the **Mode** menu as **Pattern 1** and **Pattern 2**, you may select and then complete steps 5 and 6 above to quickly use your favorite patterns.

9.4 Track mode

You can use track mode to automatically steer your vessel.

In Track mode, the autopilot automatically steers your vessel to a target waypoint or along a route plotted on your multifunction display. It makes any course changes necessary to keep your vessel on course, automatically compensating for tidal streams and leeway.

Track mode is available only if you have connected the autopilot to a suitable multifunction display with autopilot control enabled.

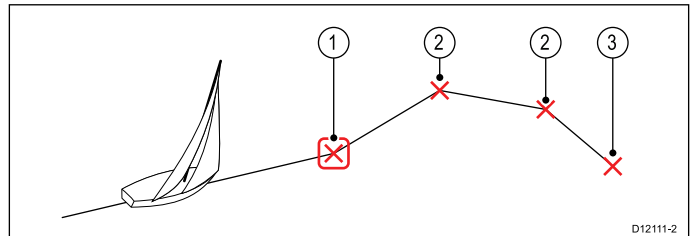

Item	Description
1	Current goto / waypoint
2	Subsequent waypoints in a route
3	Final waypoint in route

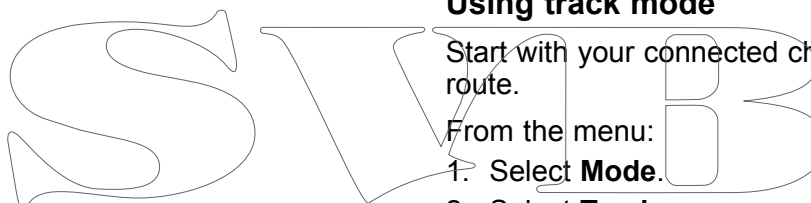

Using track mode

Start with your connected chartplotter following a route.

From the menu:

1. Select **Mode**.
2. Select **Track**.

The display will show the bearing to the next planned waypoint, and the direction in which the vessel will turn onto the track line.

3. If it is safe for the vessel to turn onto the new course, select **Track**.

The autopilot turns your vessel onto the new course with the display showing the heading required for the correct track.

Note: If the vessel is more than 0.3 nm from the track, the Large Cross Track Error warning will sound.

Waypoint arrival circle

The Waypoint Arrival Circle is a boundary line placed around the actual waypoint which, when reached triggers the waypoint arrival alarm. As the alarm is triggered by the waypoint arrival circle and not the waypoint your vessel may still be some distance from the actual waypoint when the alarm sounds. The size of the waypoint arrival circle can be customized, if the arrival circle is changed so that the radius is 0.3 nm or greater from the waypoint this can result in a cross track error alarm.

Waypoint arrival circle

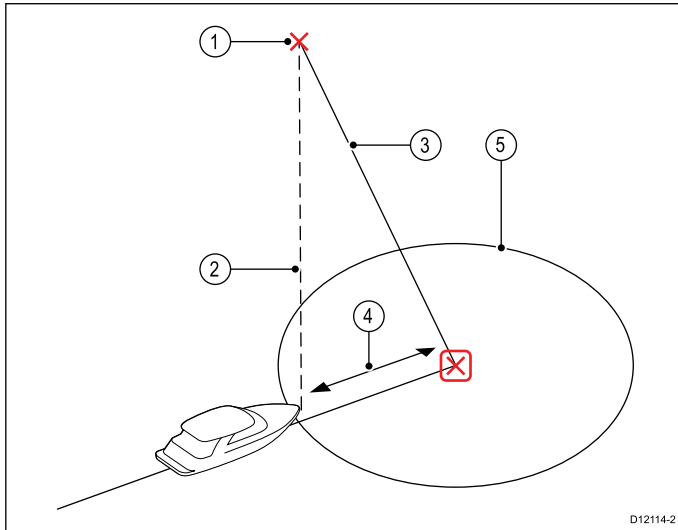

Item	Description
1	Next waypoint
2	Bearing to next waypoint
3	Track line
4	Cross track error
5	Waypoint arrival circle

Waypoint arrival

As the boat arrives at the target waypoint arrival circle the multifunction display will select the next target waypoint and transmit this to the autopilot. A Waypoint Advance warning is displayed that will identify the bearing to the next waypoint and the direction the boat will turn to acquire the new track.

Arriving at a waypoint and waypoint advance

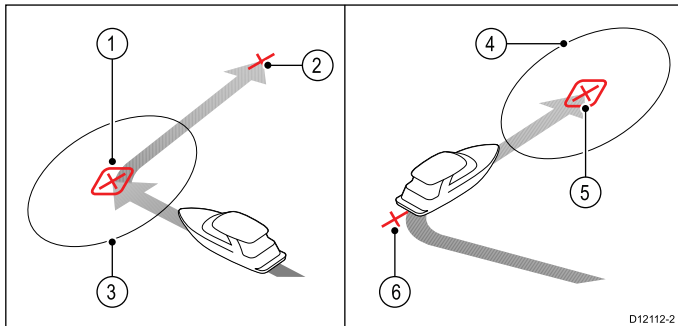

Item	Description
1	Target waypoint
2	Next waypoint
3	Waypoint arrival circle
4	Next target waypoint
5	Next waypoint arrival circle
6	Previous waypoint

Waypoint advance warning

The autopilot activates the Waypoint Advance warning in track mode whenever the target waypoint name changes. This occurs when:

- you select automatic acquisition by pressing **Track** from Auto.

- you request waypoint advance by pressing **Track** for 1 second in track mode (with SeaTalk navigators only).
 - the boat arrives at the target and the navigator accepts the next waypoint.
 - you activate the Man Overboard (MOB) function.
- When the warning sounds, the autopilot continues on its current heading but displays:
- the bearing to the next waypoint.
 - the direction the boat will turn to take up that bearing.

Arriving at a waypoint

As you approach each waypoint, an alarm sounds and a warning is displayed:

When the waypoint arrival warning is displayed:

1. Check that it is safe to turn onto the new heading.
2. If it is NOT safe or you do not want to advance to the next waypoint you can:
 - i. Select **CANCEL** or **Auto** to remain on the same heading, or
 - ii. Select **Standby** to return to manual steering.
3. If it is safe select **TRACK** to accept the new heading and proceed to the next waypoint.

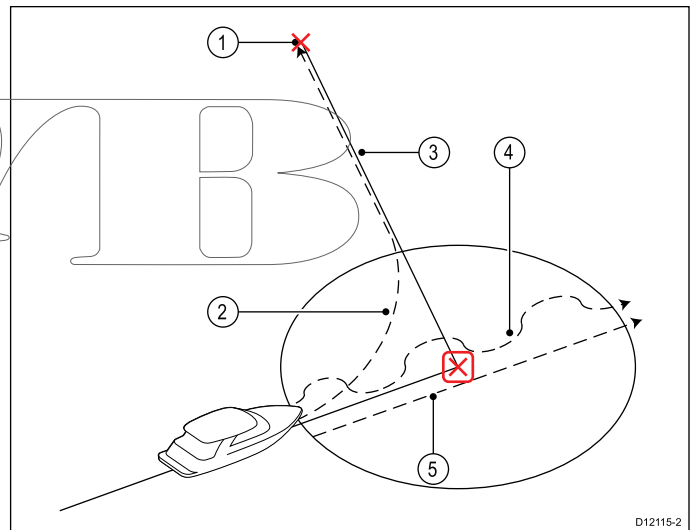

Item	Description
1	Next waypoint
2	Track — Track to next waypoint
3	Track line
4	Standby (manual control)
5	Auto or Cancel maintain current locked heading

Note: If you do not press **Track** to accept the Waypoint Advance, the autopilot will maintain the current heading and continue sounding the warning.

Cross track error

Cross track error (XTE) is the distance between the current position and a planned track line.

There are a number of reasons why you may have a cross track error (XTE), for example:

- Pressing the track button at a position some distance from the route.
- Course change to avoid an obstacle.
- Waypoint arrival under certain conditions.

If the cross track error is greater than 0.3 nm, the SmartPilot will sound the Large Cross Track Error warning and show whether you are to the port (Pt) or starboard (Stb) of the planned track.

Example 1

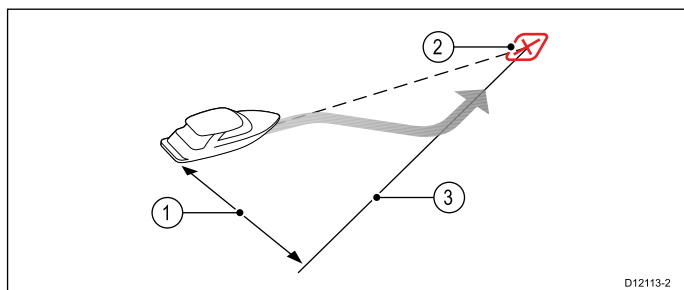

Example 1 shows the course correction which will be a turn away from the actual waypoint in order to reacquire the track line.

Item	Description
1.	Cross track error
2.	Target waypoint
3.	Track line

Note: The cross track error alarm will continue to display and sound until it is reduced to less than 0.3Nm.

Caution: Cross track error correction

When returning to TRACK mode the autopilot will correct the XTE in order to keep to the defined track leg. The direction of turn may not coincide with the bearing to waypoint and may be different from that expected.

Route completion

The autopilot displays the Route Complete warning when you have reached the last waypoint on a route.

Note: The 'Route Complete' alarm only sounds and displays in conjunction with a multifunction display.

Leaving track mode

To leave Track mode:

1. Press **AUTO** to return to Auto mode (autopilot control), or.
2. Press **STANDBY** to return to Standby mode (manual steering).

9.5 Wind vane mode (Sailing boats only)

When the autopilot is in Wind Vane mode it uses the wind angle as the primary heading reference. As changes in the true or apparent wind angle occur, it adjusts the locked heading to maintain the original wind angle.

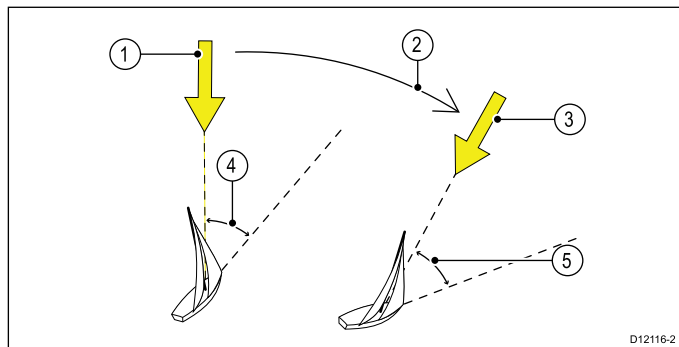

Item	Description
1	Wind direction
2	Wind shift
3	New wind direction
4	Relative wind angle
5	Vessel turns to maintain same relative wind angle

You can only select **Wind Vane** mode if your autopilot is receiving suitable **SeaTalk**, **SeaTalk^{ng}**, or **NMEA 2000** wind direction data.

Autopilots can maintain a course relative to either an **Apparent** or **True** wind angle. The default setting is **Apparent** wind. If required, you can change this to **True** wind from the **Wind Type** menu.

Using wind vane mode

You can select **Wind vane** mode from either **STANDBY** or **AUTO** mode:

1. Steady the vessel onto the required wind angle.
2. Select **Wind vane** mode:
 - i. Wind vane mode can be selected by pressing the **Auto** and **Standby** buttons together, or
 - ii. selecting **Wind vane** mode from the modes menu: **Menu > Mode > Wind vane**.

This will enable Wind vane mode and lock the current wind angle. The display shows the locked heading (e.g. 128°) and the wind angle (e.g. WIND 145P indicates a wind angle of 145° to port).
3. The autopilot will then adjust the vessel's heading to maintain the locked wind angle.

Adjusting the locked wind angle

1. You can adjust the locked wind angle by using the **-1**, **+1**, **-10** and **+10** buttons, or the **ROTARY** controller to change course. For example, to bear away by 10° when the boat is on a starboard tack:
 - i. press **-10** to turn the boat 10° to port – the locked wind angle and locked heading will both change by 10°.

- ii. the autopilot will then adjust the locked heading as required to maintain the new wind angle.

Note: Because turning the vessel affects the relationship between the true and apparent wind angles, you should only use this method to make minor adjustments to the wind angle. For major changes, return to **STANDBY** mode, steer onto the new heading, then re-select **Wind Vane** mode.

Leaving wind vane mode

To leave wind vane mode:

1. Press **AUTO** to return to Auto mode (autopilot control), or.
2. Press **STANDBY** to return to Standby mode (manual steering).

Wind Shift Alarm

Evolution autopilot

If the autopilot detects a wind shift of more than 30° for 60 seconds it will trigger the Wind Shift Alarm.

SPX and SmartPilot

If the autopilot detects a wind shift of more than 15° it will trigger the Wind Shift Alarm.

Enabling and disabling the Wind Shift alarm

The Wind Shift alarm is turned on by default, you can enable and disable the Wind Shift alarm at anytime.

In Wind Vane Mode:

1. Select **Sail Boat Settings** from the **Autopilot Calibration** menu: (**Menu > Set-up > Autopilot Calibration > Sail Boat Settings**).
2. Select **Wind Shift Alarm**.
3. Select Off to disable the alarm or On to enable the alarm.

Responding to the wind shift warning

1. To cancel the warning, and retain the existing wind angle and heading, press **Cancel**.
2. Alternatively, to cancel the warning and return to the previous heading:
 - i. adjust the locked wind angle using the **-1**, **+1**, **-10** and **+10** buttons or the **Rotary** controller.
 - ii. press **Standby** to return to manual steering, steer onto the required heading, and press **Cancel** to return to Wind Vane mode with the new wind angle.

Using AutoTack in wind vane mode

The autopilot has a built in automatic tack facility (AutoTack) that turns your vessel "relative" to the wind angle you're currently on, and it tacks the vessel to put you on the opposite relative wind angle.

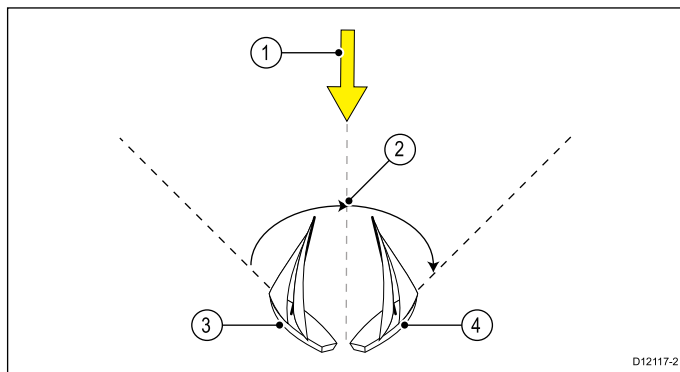

Item	Description
1	Starting position
2	Tack
3	Wind direction
4	Final position

AutoTack is always relative to wind angle and is not adjustable.

In Wind Vane mode:

1. Using a **p70 / p70s**:
 - i. Press the **-1** and **-10** buttons at the same time to Tack to port.
 - ii. Press the **+1** and **+10** buttons at the same time to Tack to starboard.
2. Using a **p70R** or a **p70Rs**:
 - i. Select **Tack Port** from the main menu to Tack to port.
 - ii. Select **Tack Starboard** from the main menu to Tack to Starboard.
- 3.

When you AutoTack in wind vane mode, the boat turns through the AutoTack angle. The autopilot will then trim the heading to mirror the locked wind angle from the previous tack.

Operating hints for wind vane mode

- Always trim your sails carefully to minimize the amount of standing helm.
- Reef the headsail and mainsail a little early rather than too late.
- In Wind Vane mode the autopilot will react to long-term wind shifts, but will not correct for short-term changes such as gusts.
- In gusty and unsteady inshore conditions, it is best to sail a few degrees further off the wind so that changes in wind direction can be tolerated.
- Avoid using Auto Tack in conditions where the wind may shift suddenly.

Caution: Allow time

Allow time for course changes

Caution: Major course changes

When making major course changes, the trim on the boat may change substantially. Due to this, the autopilot may take some time to settle accurately onto the new course.

9.6 Power steer

Power steer mode enables you to use the rotary controller of the p70Rs or a connected joystick to directly steer the vessel on manual heading.

Power steer has 2 options:

- Proportional
 - The rudder will behave in proportion to the movement of the rotary control or joystick.
- Bang Bang (Joystick only)
 - The rudder will move, and stay in the direction the joystick is moved.

Engaging power steer mode

To engage **Power steer** mode:

1. Go to the **Mode menu** found in **Main menu > Mode**.
2. Highlight **Power steer** and press **SELECT**.

You can change the type of steering at any time i.e. Proportional or Bang Bang by going to the **Power steer** settings in the **Drive settings** menu: **Main menu > Set up > Auto pilot calibration > Drive settings > Power steer**.

Accidental gybes

The gybe inhibit feature stops the vessel from turning away from the wind if you accidentally AutoTack in the wrong direction.

Note: For the gybe inhibit feature to work, the autopilot needs suitable wind data.

With gybe inhibit set to **Prevent Gybe**:

- you will be able to perform an AutoTack through the wind.
- the autopilot will prevent the boat from performing an AutoTack away from the wind.

With gybe inhibit set to **Allow Gybe**:

- you can perform an AutoTack through or away from the wind.

Note: Gybe inhibit feature can be changed from the Sail Boat Settings menu: **Menu > Set-up > Autopilot Calibration > Sail Boat Settings > Gybe Inhibit** .

Note: In order to use Bang Bang mode a connected joystick is required, the p70Rs rotary will only perform in Proportional mode.

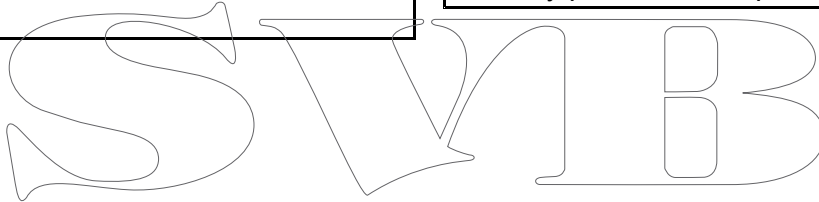

9.7 Jog steer (tiller pilots only)

If you have a tiller drive installed on a SeaTalk network, your vessel you can use the pilot controller to operate the ram in Jog steer mode.

Jog steer mode enables you to use the pilot controllers **-1**, **+1**, **-10**, **+10** buttons, or the **ROTARY** controller to move the ram in and out to aid connecting and disconnecting the ram.

Note: Jog Steer can only be used whilst your vessel is in **STANDBY**.

Using jog steer (tiller drives only)

1. Ensure your vessel pilot is in **STANDBY** mode.
2. Use the **-1** and **-10** buttons, or turn the rotary controller anticlockwise to retract the ram.
3. Use the **+1** and **+10** buttons, or turn the rotary controller clockwise to extend the ram.

9.8 Shortcut key

When in pilot view you can assign pilot modes to the **LEFT SOFT** button as a shortcut depending on which vessel type has been set up.

The following pilot modes can be assigned as shortcuts:

- Track (default) — All vessels
- Pattern — Power and fishing vessels
- Power steer — All vessels (Rotary only)
- Wind vane — Sailing vessels

Assigning the shortcut key

In order to assign a pilot mode as a shortcut mapped to the **LEFT SOFT** button follow the steps below:

1. Navigate to the **Shortcut** menu: **Menu > Mode > Shortcut**.
2. Select the required pilot mode.
3. Press **SAVE**.

The image shows the word "STANDBY" in a large, stylized, outlined font. The letters are white with a black outline, and they are set against a plain white background. The font is a serif typeface with a slightly decorative, calligraphic feel.

SWIB

Chapter 10: Pilot views

Chapter contents

- [10.1 Available pilot views on page 72](#)
- [10.2 Graphical view on page 72](#)
- [10.3 Large view on page 73](#)
- [10.4 Standard view on page 73](#)
- [10.5 Multiple view on page 74](#)
- [10.6 2D View on page 74](#)
- [10.7 Setting the pilot view on page 75](#)
- [10.8 Setting up data boxes on page 75](#)

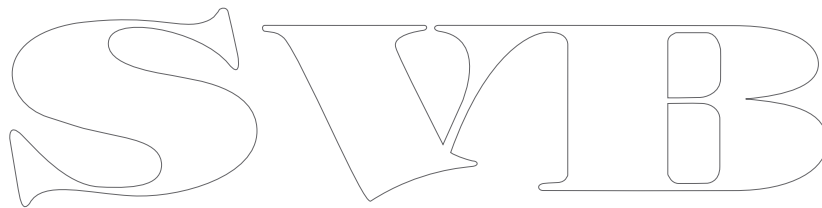

10.1 Available pilot views

Pilot views are used to display course and system data on the pilot controller's display screen.

The Available Pilot views are:

- Graphical
- Large (default)
- Standard
- Multiple
- 2D View

10.2 Graphical view

The Graphical displays a partial compass

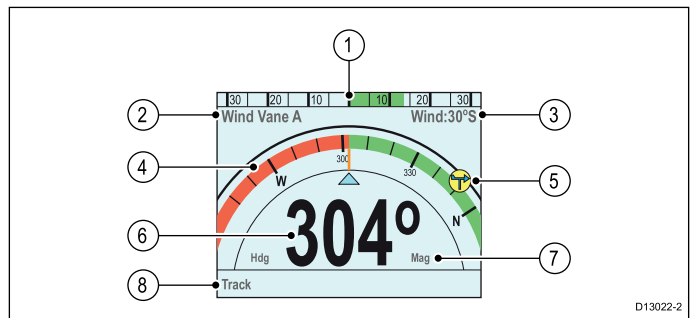

1	Rudder position
2	Pilot Mode
3	<ul style="list-style-type: none"> • Locked wind angle — Wind Vane • Pattern symbol — Pattern • Power Steer symbol — Power Steer
4	Partial compass
5	Wind direction indicator
6	<ul style="list-style-type: none"> • Current heading — Standby and Power Steer • Locked heading — Auto, Wind Vane and Pattern
7	Heading <ul style="list-style-type: none"> • Magnetic • True <p>The type of heading is determined by the language selection during the start up wizard.</p>
8	Shortcut key — Left Soft button <ul style="list-style-type: none"> • Track (default) • Pattern • Wind Vane

SWIB

Initiating Track when the Pilot View is set to Graphical will display the rolling road view.

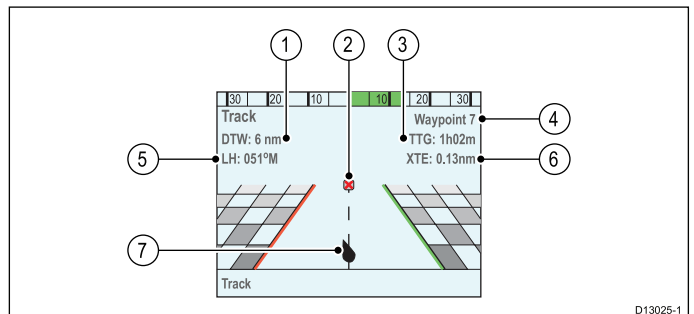

1	DTW — Distance To Waypoint
2	Destination waypoint
3	TTG — Time To Go
4	Destination waypoint name
5	Locked Heading
6	XTE — Cross Track Error
7	Vessel position

10.3 Large view

The Large view has been optimized to provide the largest possible sized text for heading data.

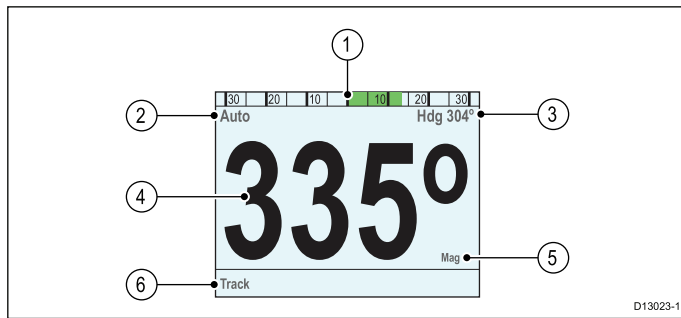

1	Rudder position
2	Pilot Mode
3	<ul style="list-style-type: none"> • Current Heading — Auto • Destination waypoint name — Track • Locked wind angle — Wind Vane • Pattern symbol — Pattern • Power Steer symbol — Power Steer
4	Heading <ul style="list-style-type: none"> • Current Heading — Standby and Power Steer • Locked Heading — Auto, Track, Wind Vane and Pattern
5	Heading <ul style="list-style-type: none"> • Magnetic • True <p>The type of heading is determined by the language selection during the start up wizard.</p>
6	Shortcut key — Left Soft button <ul style="list-style-type: none"> • Track (default) • Pattern • Wind Vane

10.4 Standard view

The Standard view provides large sized heading data combined with data boxes which provide further information.

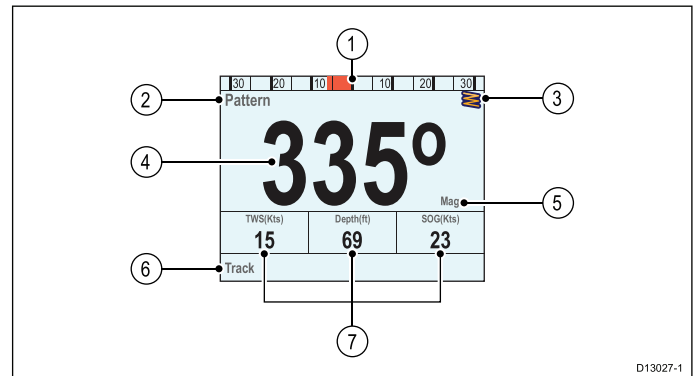

1	Rudder position
2	Pilot Mode
3	<ul style="list-style-type: none"> • Current Heading — Auto • Destination waypoint name — Track • Locked wind angle — Wind Vane • Pattern symbol — Pattern • Power Steer symbol — Power Steer
4	Heading <ul style="list-style-type: none"> • Current Heading — Standby and Power Steer • Locked Heading — Auto, Track, Wind Vane and Pattern
5	Heading <ul style="list-style-type: none"> • Magnetic • True <p>The type of heading is determined by the language selection during the start up wizard.</p>
6	Shortcut key — Left Soft button <ul style="list-style-type: none"> • Track (default) • Pattern • Wind Vane
7	Data Boxes x 3 <ul style="list-style-type: none"> • TWS (default) • Depth (default) • SOG (default)

10.5 Multiple view

The Multiple view includes multiple data boxes for displaying information.

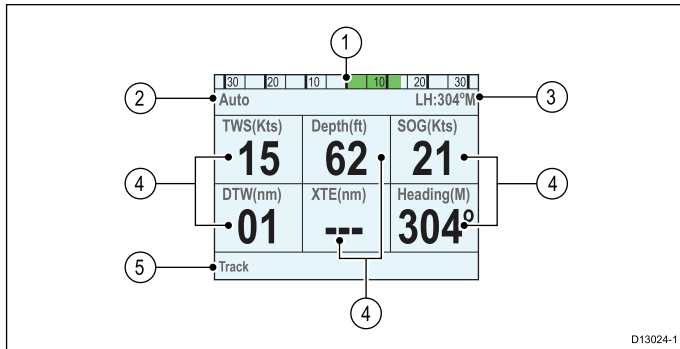

D13024-1

1	Rudder position
2	Pilot Mode
3	<ul style="list-style-type: none"> • Current Heading — Auto • Destination waypoint name — Track • Locked wind angle — Wind Vane • Pattern symbol — Pattern • Power Steer symbol — Power Steer
4	Data Boxes x 6 <ul style="list-style-type: none"> • TWS (default) • Depth (default) • SOG (default) • DTW (default) • XTE (default) • Heading (default)
5	Shortcut key — Left Soft button <ul style="list-style-type: none"> • Track (default) • Pattern • Wind Vane

10.6 2D View

The 2D view includes a full compass dial and data boxes for displaying information.

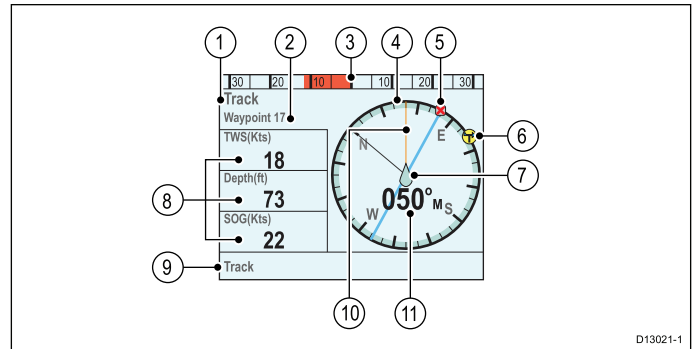

D13021-1

1	Pilot Mode
2	<ul style="list-style-type: none"> • Current Heading — Auto • Destination waypoint name — Track • Locked wind angle — Wind Vane • Pattern symbol — Pattern • Power Steer symbol — Power Steer
3	Rudder position
4	Full compass
5	Destination waypoint
6	Wind direction indicator
7	Vessel position
8	Data Boxes x 3 <ul style="list-style-type: none"> • TWS (default) • Depth (default) • SOG (default)
9	Shortcut key — Left Soft button <ul style="list-style-type: none"> • Track (default) • Pattern • Wind Vane
10	Track line
11	<ul style="list-style-type: none"> • Current heading — Standby and Power Steer • Locked heading — Auto, Wind Vane, Track and Pattern

10.7 Setting the pilot view

To set the pilot view to your desired layout:

1. Go to the **Pilot view** menu: **Main menu > Pilot view**.
2. Highlight and select **View type**.
3. Highlight the required view:
 - Graphical
 - Large
 - Standard
 - Multiple
 - 2D
4. Press **SELECT** to save the view as default.

10.8 Setting up data boxes

The Standard, Multiple and 2D Pilot views include data boxes which you can customize to display different data.

With your chosen Pilot view displayed:

1. Select **Menu**.
2. Select **Pilot View**.
3. Select **Data Boxes**.
4. Select the Data box that you want to change the data for.
A list of available data is displayed.
5. Select the relevant data type from the list.

Data boxes

The following data types are available which can be displayed in the data boxes:

Depth	
XTE	Cross track error
DTW	Distance to waypoint
BTW	Bearing to waypoint
AWA	Apparent wind angle
AWS	Apparent wind speed
TWS	True wind speed
TWA	True wind angle
COG	Course over ground
SOG	Speed over ground
Speed	
Log	
Trip	
Sea temperature	
Time	
Date	
Rate of turn	
Heading	

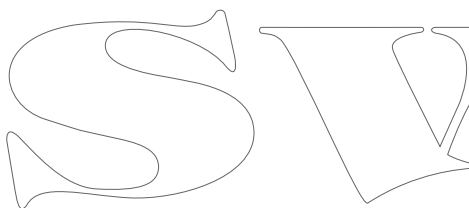

SWIB

Chapter 11: Pilot controller alarms

Chapter contents

- [11.1 Alarms on page 78](#)

SWIB

11.1 Alarms

Alarms are used to alert you to a situation or hazard requiring your attention.

Some examples of alarms are:

- Anchor alarm — Used when anchored, this alerts you to a change in depth which could mean that the chain length requires adjusting.
- Depth and speed alarms — These alarms alert you when your depth or speed moves outside of specified limits, for example a minimum depth.
- MOB (Man Overboard) alarm — Received from an MOB system.

When an alarm occurs, a message is displayed and an audible alarm may sound.



You can either:

- Silence the alarm, or
- Silence the alarm and edit the alarm settings.

Note: With the exception of the Alarm clock, Speed and Sea temperature; SeaTalk systems will only be able to switch alarms on and off, SeaTalk^{ng} systems will also be able to adjust settings.

Alarm settings

Most alarms are generated locally using specified limits. They are also transmitted on the **SeaTalk^{ng}** network.

Alarm name	Alarm type	Description	Action
Detecting magnetics		Linearization is required.	Linearize the internal compass.
Magnetic fields detected		Initial Linearization complete, further linearization will be performed in the background.	None.
Calibration required		Indicates a pilot that has not been fully calibrated. Initiated in Standby mode, for a few seconds after initial power-up.	Dockside and Seatrial calibration needs to be undertaken. <ul style="list-style-type: none"> • Change pilot mode • Self cancelling

Alarm name	Alarm type	Description	Action
Off Course		Indicates Vessel is off course by more than the pre defined alarm limit. Initiated from Auto, Track & Wind modes.	<ul style="list-style-type: none"> • Change pilot mode • Change course • Correct course
Route Complete		Flagged by chart plotter / navigator when the last waypoint in a route has been reached.	<ul style="list-style-type: none"> • Change pilot mode
Large Cross Track Error		Indicates cross track error (XTE) is greater than 0.3nm Initiated during Track mode or on entry to Track mode from any other mode.	<ul style="list-style-type: none"> • Steer back manually and enter track again. • Check autopilot settings. • Reset XTE on the multifunction display.
Loss of Waypoint data		Indicates the source (e.g. chartplotter) of the waypoint data has been lost	<ul style="list-style-type: none"> • Pilot drops out of track mode and into auto mode and continues on last locked heading. •
Wind Shift		Indicates true wind angle has changed by more than 15 degrees. Initiated from Wind vane mode only.	<ul style="list-style-type: none"> • Change pilot mode. • Change course. • Reduction of change in wind angle.

Alarm name	Alarm type	Description	Action
Auto release	Safety Alarm	Appears when the user has taken back control of the steering whilst in an engaged mode (Auto, Track, etc) using the fly-by-wire steering wheel.	<ul style="list-style-type: none"> Pilot drops to standby and alarm times out after 10 seconds.
Drive stopped	Safety Alarm	Indicates a rudder stall condition has persisted or that the power has been removed from the drive unit. Initiated in Auto, Track & Wind modes.	<ul style="list-style-type: none"> Check output from SPX, drive unit and connections. Pilot drops to standby and alarm times out after 10 seconds.
No Control Head	Safety Alarm	The course computer has lost communications with the Pilot controller, this alarm is generated by the course computer.	<ul style="list-style-type: none"> Check connections for short or open circuit. Check system for device fault. Pilot drops to standby and alarm times out after 10 seconds.
No Drive Detected	Safety Alarm	Communication between the EV unit and ACU has been lost or cannot be established.	<ul style="list-style-type: none"> Check LED diagnostics indicators. Check output from EV and ACU units. Check physical connections and cable condition, replace if necessary.

Alarm name	Alarm type	Description	Action
SeaTalk fail	Safety Alarm	Total SeaTalk data transmission problem.	<ul style="list-style-type: none"> Check connections for short or open circuit. Check system for device fault. Pilot drops to standby and alarm times out after 10 seconds.
EEPROM corruption	Safety Alarm	A corruption of critical configuration data has occurred.	<ul style="list-style-type: none"> Pilot drops to standby and alarm times out after 10 seconds.
No Pilot	Safety Alarm	The Pilot controller has lost communications with the course computer; this alarm is generated by the Pilot controller.	<ul style="list-style-type: none"> Check Seataalk or Seataalk^{ng} bus wiring between SPX and Pilot controller. Check that the course computer is powered up.
No Compass	Safety Alarm	Compass is not connected.	<ul style="list-style-type: none"> Check connections and compass transducer.
Rate Gyro fault	Safety Alarm	The gyro sensor has failed.	<ul style="list-style-type: none"> Internal Gyro failure, investigate fault and Consult a Raymarine Service Agent.

Alarm name	Alarm type	Description	Action
Current Limit	Safety Alarm	Drive overload current exceeded.	<ul style="list-style-type: none"> Check drive unit and connections for stall or short circuit wiring Pilot drops to standby and alarm times out after 10 seconds.
Rudder reference unit failure	Safety Alarm	Rudder Reference connection has been lost, or exceeded it's limits. Rudder reference transducer has failed while in auto. Angle is more than 50 degrees or connection to rudder reference is lost	<ul style="list-style-type: none"> Pilot drops to standby and alarm times out after 10 seconds.
AutoLearn fail 1 (not carried out)	Safety Alarm	Autolearn has not been carried out	<ul style="list-style-type: none"> Restart Au-toLearn.
AutoLearn fail 2 (Manual intervention)	Safety Alarm	Manual intervention during autolearn	<ul style="list-style-type: none"> Restart Au-toLearn.
AutoLearn fail 3 (Compass or drive error)	Safety Alarm	Investigate compass or drive fault	<ul style="list-style-type: none"> Restart Au-toLearn.
AutoLearn fail 4	Safety Alarm	AutoLearn has failed due to compass or drive error.	<ul style="list-style-type: none"> Restart Au-toLearn.
AutoLearn fail 5	Safety Alarm	AutoLearn has failed due to motor going into current limit.	<ul style="list-style-type: none"> Restart Au-toLearn.

Alarm name	Alarm type	Description	Action
AutoLearn fail 6	Safety Alarm	AutoLearn has failed as boat went into spin i.e. motor did not drive the rudder back to opposite side.	<ul style="list-style-type: none"> Restart Au-toLearn.
Turn rate too high	Safety Alarm	Indicates an excessive rate of turn whilst linearizing the fluxgate compass. Initiated in Calibration mode.	<ul style="list-style-type: none"> Reduce rate of turn.
Power & Motor Cables are swapped	Safety Alarm	If the motor pair and the power pair are swapped.	<ul style="list-style-type: none"> Swap motor and power wires at the course computer
Low battery	Alarm	Will appear when Battery goes below threshold set. 10 V (default)	<ul style="list-style-type: none"> Check batteries or power supply Will silence if current goes above threshold. Press cancel.
No Navigation data	Alarm	Indicates absence of one of the following primary control data items: <ul style="list-style-type: none"> Compass – Auto, Track & Wind modes. XTE – Track mode. Wind angle – Wind vane mode. 	<ul style="list-style-type: none"> Check the correct navigation data is available for the mode selected. Check the data source.

Alarm name	Alarm type	Description	Action
Pilot start up	Alarm	Will display start up for 20 seconds everytime the pilot is powered up	<ul style="list-style-type: none"> • Self cancelling.
Waypoint advance	Alarm	Indicates change in waypoint name or ID and direction to turn to new waypoint. Initiated in Track mode.	<ul style="list-style-type: none"> • Change pilot mode. • Accept new waypoint route.
No Wind data	Alarm	SmartPilot is in Wind Vane Mode but has not received Wind Angle data for 30 seconds.	<ul style="list-style-type: none"> • Check wind data source and connections. • Pilot drops out of wind vane mode and reverts to auto mode. • Change pilot mode
No speed data	Alarm	Speed data has stopped .	<ul style="list-style-type: none"> • Check Seataalk connections for short or open circuit. • Check system for Seataalk device fault.
SeaTalk 1 fail	Alarm	SeaTalk channel 1 has a communication problem.	<ul style="list-style-type: none"> • Change pilot mode.
SeaTalk 2 fail	Alarm	SeaTalk channel 2 has a communication problem.	<ul style="list-style-type: none"> • Change pilot mode.
Drive short	Warning	Indicates a short circuit in the drive unit	<ul style="list-style-type: none"> • Pilot will power down • User to fix short circuit

Alarm name	Alarm type	Description	Action
Clutch short	Warning	Indicates a short circuit in the Clutch	<ul style="list-style-type: none"> • Check clutch connections at SPX and drive unit • . Check drive unit clutch. • User to fix short circuit
Solenoid short	Warning	Indicates a short circuit in the solenoid	<ul style="list-style-type: none"> • Pilot will power down • User to fix short circuit

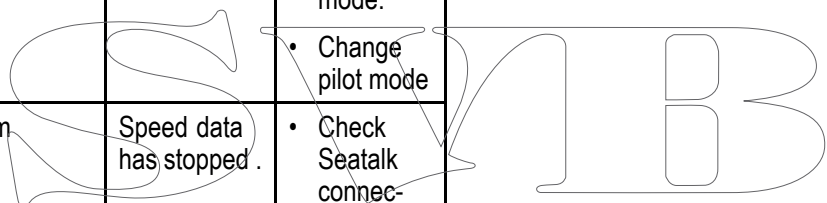

SWIB

Chapter 12: Set up menu options

Chapter contents

- [12.1 Set up menu on page 84](#)
- [12.2 Autopilot calibration menu on page 84](#)
- [12.3 User preferences menu on page 92](#)
- [12.4 System set-up menu on page 94](#)
- [12.5 Diagnostics menu on page 95](#)

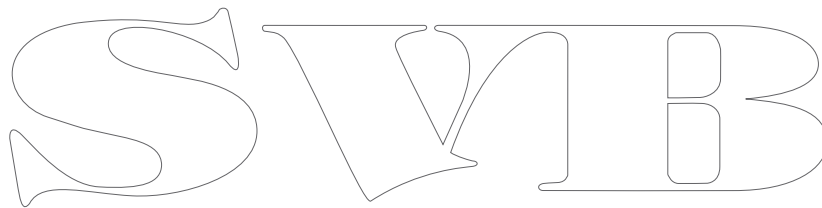

12.1 Set up menu

The set up menu provides a range of tools and settings to configure the pilot controller.

Menu item	Description	Options
Autopilot Calibration	Pilot commissioning / calibration settings	SeaTalk^{ng} <ul style="list-style-type: none"> • Vessel settings. • Drive settings. • Sailboat settings. • Commissioning. SeaTalk <ul style="list-style-type: none"> • User settings. • Dealer settings. • Seatrial calibration.
User Preferences	Set user preferences such as: Time & Date, Units of measurement, Language, Vessel type, Vessel details, and Variation.	User preferences menu.
System Set-up	Set system grouping, display and system color and brightness, Multiple data sources and about system set up.	System set up menu.
Simulator	Enables or disables simulator mode, which allows you to practice operating your instrument display without any data from any other external unit.	<ul style="list-style-type: none"> • On • Off
Factory Reset	Delete user settings and Restore unit to factory default settings.	<ul style="list-style-type: none"> • Yes • No
Diagnostics	Information About the display and system and key beep on / off setting.	<ul style="list-style-type: none"> • Yes • No
Set-up Wizard	Launch the initial set-up wizard.	<ul style="list-style-type: none"> • Language • Vessel hull type • Welcome page

12.2 Autopilot calibration menu

The Autopilot Calibration menu options are determined by the connected autopilot system.

Note: Not all options are available when Calibration Lock is turned On.	
Note:	
<ul style="list-style-type: none"> • (1) — SPX and SeaTalk SmartPilots only. • (2) — Evolution autopilots only. 	
Menu	Options
Vessel Settings	<ul style="list-style-type: none"> • Vessel Hull Type • Drive Type • Cruise Speed ⁽¹⁾ • Compass Offset • Latitude Compass Damping ⁽¹⁾ • Calibration Lock
Drive Settings	<ul style="list-style-type: none"> • Rudder Gain ⁽¹⁾ • Response Level ⁽¹⁾ • Counter Rudder ⁽¹⁾ • Rudder Damping • Auto Trim ⁽¹⁾ • Auto Turn • Power Steer ⁽²⁾ • Reverse Rudder Ref. • Off Course Alarm ⁽¹⁾ • Turn Rate Limit ⁽¹⁾ • Motor Phasing • Rudder Limit • Rudder Offset ⁽²⁾ • Hard Over Time

Menu	Options
Sail Boat Settings	<ul style="list-style-type: none"> • Gybe Inhibit • Wind Type • Wind Trim Response (1) • Wind Shift Alarm (2)
Commissioning	<ul style="list-style-type: none"> • Dockside Wizard • Sea Trial Wizard (1) • Motor Phasing (1) • Swing Compass (1) • Auto Learn (1) • Align Compass GPS • Align Compass (1) • Restart Compass (2) • Compass Lock (2) • Pilot Factory Reset • Debug Level (2) • ACU Debug Level (2)

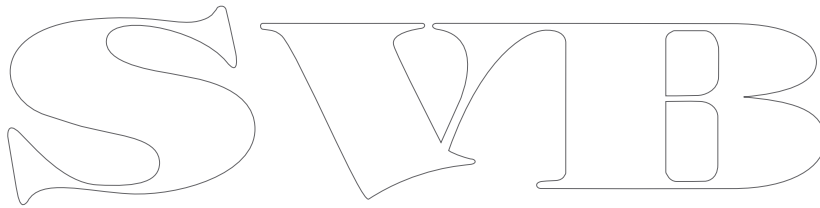

Vessel Settings

Vessel settings are dependant on connected autopilot system and vessel drive type.

The Vessel settings menu can be accessed from: **Menu > Set-up > Autopilot Calibration > Vessel Settings**.

Note: When connected to a SeaTalk system the vessel settings listed below are part of the **Dealer settings** menu, **Menu > Set-up > Autopilot Calibration > Dealer Settings**.

Note: Not all options are available when **Calibration Lock** is turned On.

Item	Description	Evolution autopilots	SeaTalk and SPX SmartPilot Options
Vessel hull type	The vessel type options will normally give optimum performance for typical vessels of each type. However, you may find you can improve the performance of your vessel by selecting an option for a different vessel type.	<ul style="list-style-type: none"> • Sail. • Sail (Slow turn). • Sail Catamaran. • Power. • Power (slow turn). • Power (fast turn). 	<ul style="list-style-type: none"> • Race sail. • Sail cruiser. • Catamaran. • Workboat. • RIB. • Outboard speed boat. • Inboard speed boat. • Power cruiser 1. — Vessel speeds up to 12 knots. • Power cruiser 2.— Vessel speeds up to 30 knots. • Power cruiser 3 — Vessels speeds greater than 30 knots. • Sport fishing. • Pro fishing.
Drive type	<p>List of compatible drive types. The list is dependant upon connected autopilot system.</p> <div style="border: 1px solid black; padding: 5px; margin-top: 10px;"> <p>Note: The drive type option is not available in systems comprising of an EV-2 and an ACU-300.</p> </div>	<ul style="list-style-type: none"> • Type 1 Linear — ACU-200 and ACU-400 • Type 2 Linear — ACU-400 only • Type 2 Hydraulic Linear — ACU-400 only • Type 3 Hydraulic Linear — ACU-400 only • I/O Stern — ACU-200 and ACU-400 • Wheel Drive — ACU-100, ACU-200 and ACU-400 • Tiller — ACU-100, ACU-200 and ACU-400 • CR Solenoid — auto detected — ACU-300 only (not selectable) • Sport Drive — ACU-200 and ACU-400 • Rotary Drive Type 1 — ACU-200 and ACU-400 • Rotary Drive Type 2 — ACU-400 only • Hydraulic Pump Type 1 (0.5L) — ACU-100 only • Hydraulic Pump Type 1 — ACU-200 and ACU-400 	<ul style="list-style-type: none"> • Type 1 linear • Type 2 linear • Type 3 linear • Hydraulic pump type 1 • Hydraulic pump type 2 • Hydraulic pump type 3 • Rotary drive type 1 • Rotary drive type 2 • Rotary type 1 • Rotary type 2 • I/O stern • CAN • Wheel drive. • Tiller • Sport drive • Constant running pump. • Verado

Item	Description	Evolution autopilots	SeaTalk and SPX SmartPilot Options
		<ul style="list-style-type: none"> Hydraulic Pump Type 2 — ACU-400 only Hydraulic Pump Type 3 — ACU-400 only Verado — ACU-200 and ACU-400 	
Speed Input	Select the source for speed data. In Auto the system will automatically choose the lowest value between Speed and SOG Cruise speed allows you to set a static speed.	<ul style="list-style-type: none"> Auto Speed (STW) SOG Cruise speed 	N/A
Cruise speed	Set the cruise speed to the vessel's typical cruising speed. If no speed data is available, the SmartPilot system will use the cruise speed value you set as a default.	<ul style="list-style-type: none"> 0 to 99 Kts 	<ul style="list-style-type: none"> 0 to 99 Kts
Compass Offset	On systems without a GPS then the compass heading must be manually aligned to the vessels known heading.	<ul style="list-style-type: none"> -10° to 10° 	<ul style="list-style-type: none"> -179° to 180°
Latitude Compass Damping	If no valid latitude data is available, the autopilot system will use this setting which provides the necessary adaptation for higher latitudes.	N/A	<ul style="list-style-type: none"> On Off (default)
Auto release	<p>Auto release allows you to override the pilot by taking hold of the wheel or tiller. When you release the wheel or tiller, the pilot will return to the last locked heading.</p> <div style="border: 1px solid black; padding: 5px; width: fit-content;"> <p>Note: Only available on S1, S2, or S3 course computers only with drive type set to I/O stern.</p> </div>	N/A	<ul style="list-style-type: none"> Enable (default) Disable
Calibration lock	The calibration lock is used to lock out specific calibration settings which if changed may require recommissioning of the autopilot system. If your system has been dealer installed then the lock may be turned on.	<ul style="list-style-type: none"> On (default) Off 	<ul style="list-style-type: none"> On Off (default)

Drive settings

The Drive Settings menu can be accessed from: **Menu > Set-up > Autopilot Calibration > Drive Settings.**

Note: Not all options are available when Calibration Lock is turned On.		
Item	Description	Options
*Rudder gain	Rudder gain is a measure of how much helm the autopilot will apply to correct course errors. A higher setting results in more rudder being applied. The rudder gain setting is set automatically as part of the Auto Learn process.	<ul style="list-style-type: none"> • 1 — 9
*Counter rudder	Counter rudder is the amount of rudder the autopilot system applies to try to prevent the vessel from yawing off course. A higher counter rudder setting results in more rudder being applied	<ul style="list-style-type: none"> • 1 — 9 Do not set to 0.
Rudder damping	On autopilot systems with a rudder reference transducer, you can set the rudder damping to prevent autopilot 'hunting'. Increasing the rudder damping value reduces hunting. When adjusting the value, increase the setting one level at a time until the autopilot stops hunting. Always use the lowest acceptable value. Rudder Damping	<ul style="list-style-type: none"> • 1 — 9 • 3 (default)
Rudder limit	If a rudder reference transducer is fitted, this screen is used to set the limits of the rudder control just inside the mechanical end stops, and thus avoid putting the steering system under unnecessary load. This should be set when commissioning the system. The limit should be set to approximately 5 degrees less than the maximum rudder angle. Note: If no rudder reference has been fitted you MUST ensure that adequate provision is made to prevent the steering mechanism from impacting the end stops.	<ul style="list-style-type: none"> • 10° — 40° • 30° (default)
Rudder offset	This specifies the offset from amidships (zero adjustment).	<ul style="list-style-type: none"> • -9° to 9°
Reverse rudder ref	This reverses the phase of the rudder reference display. Note: This option is not available unless you have a rudder reference transducer fitted. Note: This option is not available on SeaTalk systems, so you would need to reverse the RED and GREEN wires on the Rudder Reference connection to the course computer.	<ul style="list-style-type: none"> • Port • Starboard
*Auto Trim	The Auto Trim setting determines the rate at which the autopilot system applies 'standing helm' to correct for trim changes caused by varying wind loads on the sails or superstructure. The default Auto Trim is set as part of the Auto Learn process. If you need to change the setting, increase the Auto Trim one level at a time and use the lowest acceptable value: <ul style="list-style-type: none"> • If the autopilot system gives unstable course keeping or excessive drive activity with a change in the heel angle, decrease the Auto Trim level. • If the autopilot system reacts slowly to a heading change due to a change in the heel angle, increase the Auto Trim level. • If the Auto Trim level is too high, the vessel will be less stable and snake around the desired course. 	Setting <ul style="list-style-type: none"> • Off • On Adjustment <ul style="list-style-type: none"> • 1 — 4 1 = Slowest, 4 = Fastest • 1 (default)
Auto Turn	This setting defines the amount of course change when performing an auto turn. Note: This option cannot be changed when connected over SeaTalk. Note: This option is only available on motor vessels.	<ul style="list-style-type: none"> • 10° — 125° • 90° (default)

Item	Description	Options
Response level	<p>This sets the default autopilot system response level setting. The response level controls the relationship between course keeping accuracy and the amount of helm / drive activity. You can make temporary changes to response during normal operation.</p> <p>Evolution On Evolution autopilots the Response level setting is available from the main menu: Menu > Response Level</p> <p>SeaTalk and SPX SmartPilot levels</p> <ul style="list-style-type: none"> • Level 1 — 3 Minimize the amount of pilot activity. This conserves power, but may compromise short-term course-keeping accuracy. • Level 4 — 6 Should give good course keeping with crisp, well controlled turns under normal operating conditions. • Level 7 — 9 Gives the tightest course keeping and greatest rudder activity (and power consumption). This can lead to a rough passage in open waters as the SPX system may 'fight' the sea. 	<p>Evolution</p> <ul style="list-style-type: none"> • Performance • Cruising • Leisure <p>SeaTalk and SPX SmartPilot</p> <ul style="list-style-type: none"> • 1 — 9 • 5 (default)
*Off course alarm	<p>This screen determines the angle used by the OFF COURSE alarm. The OFF COURSE alarm operates if the pilot strays off course by more than the specified angle for more than 20 seconds.</p>	<ul style="list-style-type: none"> • 15° to 40° • 20° (default)
*Turn rate limit	<p>This limits your vessel's rate of turn under autopilot system control. It is only effective if your speed is greater than 12 knots.</p>	<ul style="list-style-type: none"> • 1° to 30° • 7° (default)
Power steer	<p>This screen determines the behavior of the Rotary or joystick when in power steer mode.</p> <div style="border: 1px solid black; padding: 5px; margin: 10px 0;"> <p>Note: Power Steer mode is only available if the system includes a rudder reference transducer and speed data is available</p> </div> <ul style="list-style-type: none"> • Off • Proportional The steering will behave in proportion to the movement of the rotary controller or joystick. • Bang Bang (Joystick only) The rudder will move, and stay in the direction a joystick is moved. 	<ul style="list-style-type: none"> • Off • Proportional • Bang Bang
Hard over time	<p>On vessels without a rudder reference transducer, it is of critical importance to set the hard over time, to ensure accurate autopilot operation. The Default value is determined by Drive type selection.</p>	<ul style="list-style-type: none"> • Value is seconds

Note: * SPX and SeaTalk SmartPilots only.

Sail boat settings

These settings are only available to sail boats.

The Sail Boat settings menu can be accessed from: **Menu > Set-up > Autopilot Calibration > Sail Boat Settings.**

Note: When connected to a SeaTalk system the Sail boat settings listed below are part of the **User settings** menu: **Menu > Set-up > Autopilot Calibration > User Settings.**

Item	Description	Evolution autopilots	SeaTalk and SPX SmartPilot
Gybe inhibit	With gybe inhibit set to allow, the autopilot will allow the vessel to tack through / into and away from the wind. With gybe inhibit set to prevent, you can only tack through / into the wind. Gybe inhibit does not effect Auto Turn	<ul style="list-style-type: none"> • Allow Gybe • Prevent Gybe 	<ul style="list-style-type: none"> • Allow Gybe • Prevent Gybe
Wind Type	This option determines whether the vessel steers to apparent or true wind in Wind Vane mode.	<ul style="list-style-type: none"> • True • Apparent 	<ul style="list-style-type: none"> • True • Apparent
Wind Trim Response	Wind Trim Response controls how quickly the autopilot responds to changes in wind direction. Higher wind trim settings will result in a system that is more responsive to wind changes.	N/A	<ul style="list-style-type: none"> • 1 to 9 • 5 (default)
Wind Shift Alarm	This option enables you to enable and disable the Wind Shift alarm.	<ul style="list-style-type: none"> • On (default) • Off 	N/A

Note: These features are only available if wind data is available.

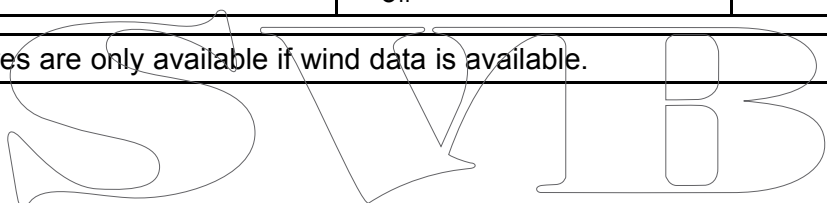

Commissioning menu

Commissioning menu options are dependant on connected autopilot system.

Menu option	Description	Evolution autopilots	SeaTalk and SPX SmartPilots
Dockside Wizard	Initiates the Dockside wizard process.	Yes	Yes
Sea Trial Wizard	Initiates the Sea Trial wizard process.	N/A	Yes
Motor phasing	Initiates the motor phasing (drive check) wizard	N/A	Yes
Swing Compass	Initiates the swing compass wizard	N/A	Yes
Auto Learn	Initiates the Auto Learn process	N/A	Yes
Align Compass GPS ⁽¹⁾	Initiates the align compass to GPS heading wizard	Yes	Yes
Align Compass ⁽¹⁾	Manual adjustment of the compass offset	• -10° to 10°	• -179° to 180°
Pilot Factory Reset	Resets the autopilots course computer to factory default settings.	• Yes • No	• Yes • No
Restart Compass	Restarts the compass	• Yes • Cancel	N/A
Compass Lock	Locks the compass from performing further automatic linearization.	• On • Off	N/A
Debug Level ⁽¹⁾	Sets the debug value for troubleshooting purposes. The recommended Debug setting is 7. Note: The Debug level should only be set temporarily, usually when requested by Technical Support as part of a troubleshooting sea trial.	• 0 — 63	N/A
ACU Debug Level ⁽¹⁾	Sets the debug value for troubleshooting purposes. The recommended Debug setting is 7. Note: The Debug level should only be set temporarily, usually when requested by Technical Support as part of a troubleshooting sea trial.	• 0 — 127	N/A

Note: ⁽¹⁾ Option not available when **Calibration Lock** is turned On.

User Settings

When connected to a SeaTalk autopilot system a User settings menu will be available.

The User settings menu can be accessed from: **Main Menu > Set up > Autopilot calibration > User settings**. Once entered the user settings menu will cycle through all available options. These

options shall be available to users when calibration lock is turned on.

12.3 User preferences menu

The **User preferences** menu enables users to customize user settings.

Menu item	Description	Options
Time & Date	These options enable you to customize the date and time format to your requirements. You can also specify a local time offset from Universal Time Constant (UTC), to compensate for any time zone difference.	Date format: <ul style="list-style-type: none"> • mm/dd/yy • dd/mm/yy Time format: <ul style="list-style-type: none"> • 12hr • 24hr Time offset: <ul style="list-style-type: none"> • -13 to +13 hours
Units	Enables you to specify the units used for the following key measurements: <ul style="list-style-type: none"> • Speed • Distance • Depth • Wind speed • Temperature • Flow rate • Heading • Pressure • Volume • Barometric 	Speed: <ul style="list-style-type: none"> • kts — knots. • mph — miles per hour. • km/h — Kilometers per hour. Distance: <ul style="list-style-type: none"> • nm — Nautical miles. • sm — Statute miles. • km — Kilometers. Depth: <ul style="list-style-type: none"> • ft — Feet • m — Metres • fa — Fathoms Wind speed: <ul style="list-style-type: none"> • kts — knots. • m/s — metres per second. Temperature: <ul style="list-style-type: none"> • °C — degrees centigrade. • °F — degrees fahrenheit. Flow Rate <ul style="list-style-type: none"> • UK Gal/H — UK gallons per hour. • US Gal/H — US gallons per hour. • LPH — Liters per hour. Heading: <ul style="list-style-type: none"> • Mag — magnetic. • True Pressure <ul style="list-style-type: none"> • PSI — pounds per square inch. • Bar — bar. • kPa — Kilo pascals. Volume: <ul style="list-style-type: none"> • UK Gallons • US Gallons

Menu item	Description	Options
		<ul style="list-style-type: none"> • ltr — liter.
Language	Determines the language that will be used for all on-screen text, labels, menus and options.	<ul style="list-style-type: none"> • English (UK) • English (US) • Chinese • Croatian • Danish • Dutch • Finnish • French • German • Greek • Italian • Japanese • Korean • Norwegian • Polish • Portuguese (Brazilian) • Russian • Spanish • Swedish • Turkish
Variation	<p>Enables you to turn on and off magnetic variation, specify slave source or adjust manually.</p> <ul style="list-style-type: none"> • Variation mode • Variation range 	<p>Variation mode:</p> <ul style="list-style-type: none"> • On • Off (default) • Slave <p>Variation range:</p> <ul style="list-style-type: none"> • -30° — +30°
Key Beep	Enable and disable the audible beep when pressing buttons.	<ul style="list-style-type: none"> • On (default) • Off

12.4 System set-up menu

The **System set-up** menu enables users to customize the following user settings:

Menu item	Description	Options
Network group	Allows adding multiple units together in a group so that when the color scheme or brightness is changed on one unit the changes are applied to all units in the group.	Predefined groups <ul style="list-style-type: none"> • None • Helm 1 • Helm 2 • Cockpit • Flybridge • Mast Undefined <ul style="list-style-type: none"> • Group-1 — Group-5
Brightness / color group	Enables synchronization of the displays brightness and color to be the same as the other units in the same group.	Sync brightness / color <ul style="list-style-type: none"> • This display • This group
Data sources	Allows you to view and select preferred data sources. <ul style="list-style-type: none"> • Select data source • Data source found • Data source details 	Select data source <ul style="list-style-type: none"> • GPS position • GPS Datum • Time & Date • Heading • Depth • Speed • Wind Data source found <ul style="list-style-type: none"> • model name — serial number Port ID Data source details <ul style="list-style-type: none"> • Device name • Serial No. • Port ID • Status or No data
About system set-up	Provides information about the System set-up menu.	

12.5 Diagnostics menu

You can access diagnostics details from the **Diagnostics** menu: (**Menu > Set-up > Diagnostics**).

Menu item	Description	Options
About display	Allows you to view information about the display you are using:	<ul style="list-style-type: none"> • Software version • Hardware version • Bootloader version • Temperature • Volts • Max. volts • Current • Max. current • Run time • Deviation (If available)
About Pilot	Allows you to view information about the autopilot you are using: <div style="border: 1px solid black; padding: 5px; margin-top: 10px;"> <p>Note: The About Pilot menu is only available on Pilot controllers.</p> </div>	<ul style="list-style-type: none"> • NMEA Code • Product ID • Serial number • Description • Software version • PCB Number • CAN Volts • Unit Volts • Operating hours • Deviation
About system	Allows you to search the SeaTalk^{ng} network and display information about the products found.	<ul style="list-style-type: none"> • Model number • Serial number • Software version • Hardware version • Volts
Self test	The product has a built in self test which can help to diagnose faults. Self-Test include: <ul style="list-style-type: none"> • Memory test • Button test • Display test • Buzzer test • Illumination test 	N/A

SWIB

Chapter 13: Maintenance

Chapter contents

- 13.1 Routine equipment checks on page 98
- 13.2 Product cleaning on page 98
- 13.3 Cleaning the display screen on page 99
- 13.4 Cleaning the display case on page 99
- 13.5 Cleaning the sun cover on page 100

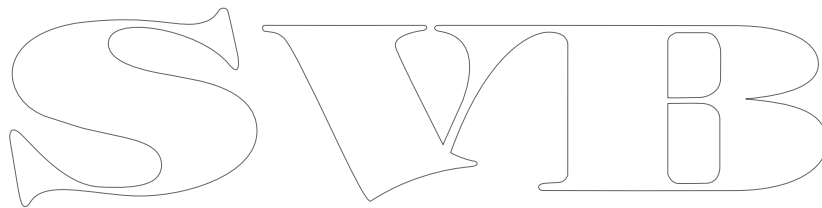

13.1 Routine equipment checks

Raymarine strongly recommends that you complete a number of routine checks to ensure the correct and reliable operation of your equipment.

Complete the following checks on a regular basis:

- Examine all cables for signs of damage or wear and tear.
- Check that all cables are securely connected.

13.2 Product cleaning

Best cleaning practices.

When cleaning products:

- If your product includes a display screen, do NOT wipe the screen with a dry cloth, as this could scratch the screen coating.
- Do NOT use abrasive, or acid or ammonia based products.
- Do NOT use a jet wash.

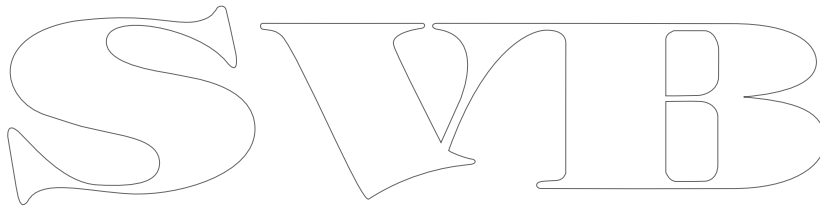
The image shows a large, stylized outline logo for 'SWIB'. The letters are interconnected and have a decorative, calligraphic feel. The 'S' is on the left, followed by 'W', 'I', and 'B' on the right. The entire logo is rendered in a simple black outline on a white background.

13.3 Cleaning the display screen

A coating is applied to the display screen. This makes it water repellent, and prevents glare. To avoid damaging this coating, follow this procedure:

1. Switch off the power to the display.
2. Rinse the screen with fresh water to remove all dirt particles and salt deposits.
3. Allow the screen to dry naturally.
4. If any smears remain, very gently wipe the screen with a clean microfibre cleaning cloth (available from an opticians).

13.4 Cleaning the display case

The display unit is a sealed unit and does not require regular cleaning. If it is necessary to clean the unit, follow this basic procedure:

1. Switch off the power to the display.
2. Wipe the display with a clean, soft cloth (a microfibre cloth is ideal).
3. If necessary, use a mild detergent to remove grease marks.

Note: Do NOT use solvents or detergents on the screen itself.

Note: In certain conditions, condensation may appear inside the display screen. This will not harm the unit, and can be cleared by powering on the display for a short time.

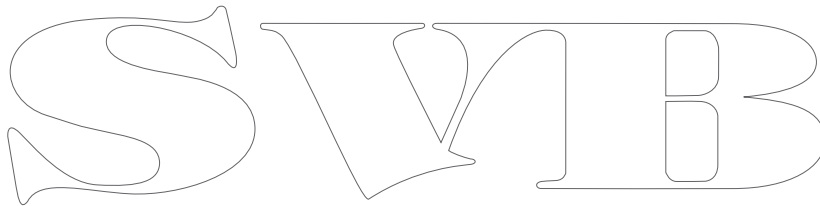

13.5 Cleaning the sun cover

The supplied sun cover features an adhesive surface. In certain conditions unwanted contaminants may stick to this surface. To avoid damaging the monitor display, clean the sun cover regularly following this procedure:

1. Carefully remove the sun cover from the display.
2. Rinse the sun cover with fresh water to remove all dirt particles and salt deposits.
3. Allow the sun cover to dry naturally.

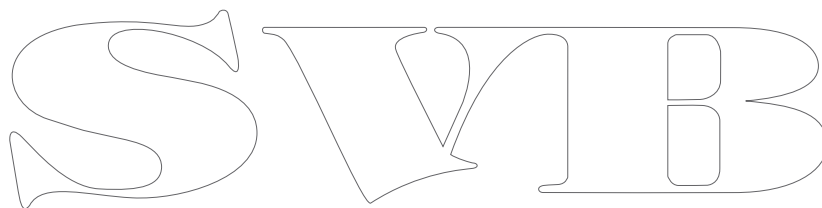
The image shows a stylized outline logo for 'SWIB'. The letters are rendered in a decorative, serif font with intricate flourishes. The 'S' is on the left, followed by 'W', 'I', and 'B' on the right. The entire logo is composed of a single continuous line.

Chapter 14: System checks and troubleshooting

Chapter contents

- [14.1 Troubleshooting on page 102](#)
- [14.2 Power up troubleshooting on page 103](#)
- [14.3 System data troubleshooting on page 104](#)
- [14.4 Miscellaneous troubleshooting on page 105](#)
- [14.5 Performing a Factory Reset on page 106](#)

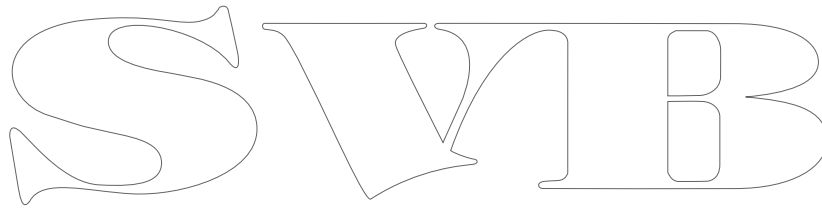

14.1 Troubleshooting

The troubleshooting information provides possible causes and corrective action required for common problems associated with marine electronics installations.

All Raymarine products are, prior to packing and shipping, subjected to comprehensive test and quality assurance programs. However, if you experience problems with the operation of your product this section will help you to diagnose and correct problems in order to restore normal operation.

If after referring to this section you are still having problems with your unit, please contact Raymarine Technical Support for further advice.

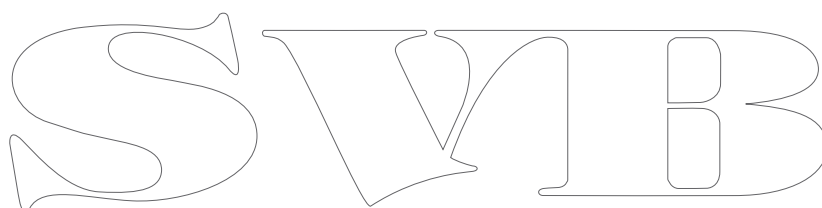
A large, stylized outline logo consisting of the letters 'S', 'W', 'I', and 'B' in a decorative, serif font. The letters are interconnected and have a classic, elegant appearance.

14.2 Power up troubleshooting

Problems at power up and their possible causes and solutions are described here.

Product does not turn on or keeps turning off

Possible causes	Possible solutions
Blown fuse / tripped breaker	<ol style="list-style-type: none"> 1. Check condition of relevant fuses and breakers and connections, replace if necessary (Refer to the <i>Technical Specification</i> section of your product's installation instructions for fuse ratings.) 2. If fuse keeps blowing check for cable damage, broken connector pins or incorrect wiring.
Poor / damaged / insecure power supply cable / connections	<ol style="list-style-type: none"> 1. Check that the power cable connector is fully inserted into the unit and locked in position. 2. Check the power supply cable and connectors for signs of damage or corrosion, replace if necessary. 3. With the unit turned on, try flexing the power cable near to the display connector to see if this causes the unit to re-boot/loose power, replace if necessary. 4. Check the vessel's battery voltage, the condition of the battery terminals and power supply cables, ensuring connections are secure, clean and free from corrosion, replace if necessary. 5. With the product under load, using a multi-meter, check for high voltage drop across all connectors/fuses etc, replace if necessary.
Incorrect power connection	The power supply may be wired incorrectly, ensure the installation instructions have been followed.
Power source insufficient	With the product under load, using a multi-meter, check the power supply voltage as close to the unit as possible to establish actual voltage when the current is flowing. (Refer to the <i>Technical Specification</i> section of your product's installation instructions for power supply requirements.)

Product will not boot up (re-boot loop)

Possible causes	Possible solutions
Power supply and connection	See possible solutions from 'Products does not turn on or keeps turning off' above.
Software corruption	<ol style="list-style-type: none"> 1. In the unlikely event that the products software has become corrupted please try re-flashing the latest software from the Raymarine website. 2. On display products, as a last resort, you can try to perform a 'Power on Reset', however this will delete all settings/presets and user data (such as waypoints and tracks) and revert the unit back to factory defaults.

14.3 System data troubleshooting

Aspects of the installation can cause problems with the data shared between connected equipment. Such problems, their possible causes and solutions are described here.

Problem	Possible causes	Possible solutions
Instrument, engine or other system data is unavailable at all displays.	Data is not being received at the display.	Check the data bus (e.g. SeaTalk^{ng}) wiring and connections.
		Check the overall integrity of the data bus (e.g. SeaTalk^{ng}) wiring.
		If available refer to the reference guide for the data bus (e.g. SeaTalk^{ng} reference manual).
	Data source (e.g. instrument display or engine interface) is not operating.	Check the source of the missing data (e.g. instrument display or engine interface).
		Check the power to the SeaTalk bus.
		Refer to the manufacturer's handbook for the equipment in question.
Software mismatch between equipment may prevent communication.	Contact Raymarine technical support.	
Instrument or other system data is missing from some but not all displays.	Network problem.	Check that all required equipment is connected to the network.
		Check the status of the Raymarine network Switch.
		Check that SeaTalk^{hs} / RayNet cables are free from damage.
	Software mismatch between equipment may prevent communication.	Contact Raymarine technical support.
Position data is not displayed on VHF radio	VHF radio NMEA 0183 input not isolated / incorrect polarity	<ul style="list-style-type: none"> • Check that the radio has an isolated NMEA 0183 input. • Check polarity of NMEA 0183 wires.

14.4 Miscellaneous troubleshooting

Miscellaneous problems and their possible causes and solutions are described here.

Problem	Possible causes	Possible solutions
Display behaves erratically: <ul style="list-style-type: none"> • Frequent unexpected resets. • System crashes or other erratic behavior. 	Intermittent problem with power to the display.	Check relevant fuses and breakers.
		Check that the power supply cable is sound and that all connections are tight and free from corrosion.
	Check that the power source is of the correct voltage and sufficient current.	Go to www.raymarine.com and click on support for the latest software downloads.
	Software mismatch on system (upgrade required).	Perform a factory reset.
	Corrupt data / other unknown issue.	<div style="border: 1px solid black; padding: 5px;"> <p>Important: This will result in the loss of any settings and data (such as waypoints) stored on the product. Save any important data to a memory card before resetting.</p> </div>

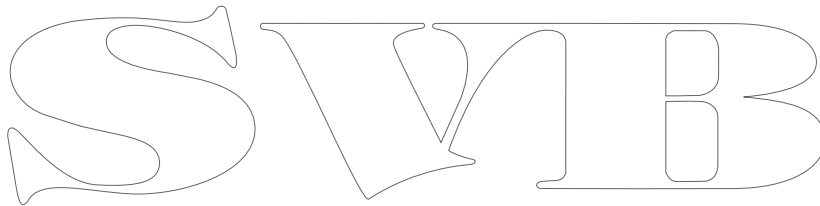

The image shows a large, stylized outline logo for 'SVMB'. The letters are interconnected and have a decorative, calligraphic feel. The 'S' is on the left, followed by 'V', 'M', and 'B' on the right.

14.5 Performing a Factory Reset

To reset your unit to factory default settings follow the steps below.

Note: Performing a factory reset will erase all saved data and customized settings.

1. Press the **Menu** button.
2. Select **Set Up**.
3. Select **Factory Reset**.
4. Select **Yes**.

Your unit will now reset itself to factory default settings.

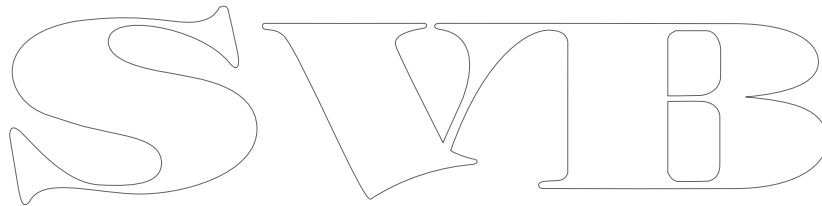
The image shows a large, stylized outline logo for 'SWIB'. The letters are bold and have a decorative, slightly calligraphic feel. The 'S' is on the left, followed by 'W', 'I', and 'B' on the right. The entire logo is rendered in a simple black outline.

Chapter 15: Technical specification

Chapter contents

- [15.1 Technical specification on page 108](#)

SWIB

15.1 Technical specification

Nominal supply voltage	12 V dc
Operating voltage range	9 V dc to 16 V dc (protected up to 32 V dc)
Current	131 mA
Power consumption	1.57 W
LEN (Refer to the SeaTalk ^{ng} reference manual for further information.)	3
Operating Temperature Range	-20°C to 55°C (-4°F to 131°F)
Storage Temperature Range	-30°C to 70°C (-22°F to 158°F)
Relative Humidity	93% Max.
Water proofing	IPX6 and IPX7
Display screen	<ul style="list-style-type: none"> • 3.45" TFT LCD display • 16bit color (64k colors) • Resolution: 320(H) x 240(V) • Brightness: 1,200 cd/m2
Data connections	1 x SeaTalk^{ng} ® connector
Conformance	<ul style="list-style-type: none"> • NMEA 2000 certification pending • Europe 2004/108/EC • Australia and New Zealand C-Tick, compliance level 2

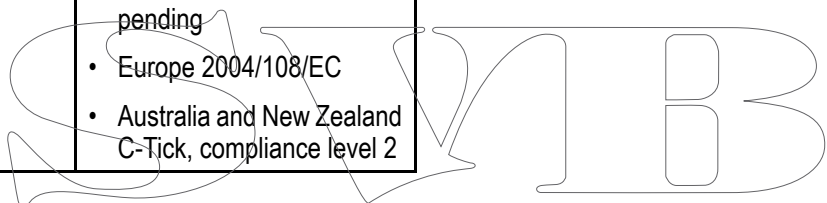

Chapter 16: Technical support

Chapter contents

- [16.1 Raymarine product support and servicing on page 110](#)
- [16.2 Learning resources on page 111](#)

SWIB

16.1 Raymarine product support and servicing

Raymarine provides a comprehensive product support service, as well as warranty, service, and repairs. You can access these services through the Raymarine website, telephone, and e-mail.

Product information

If you need to request service or support, please have the following information to hand:

- Product name.
- Product identity.
- Serial number.
- Software application version.
- System diagrams.

You can obtain this product information using the menus within your product.

Servicing and warranty

Raymarine offers dedicated service departments for warranty, service, and repairs.

Don't forget to visit the Raymarine website to register your product for extended warranty benefits: <http://www.raymarine.co.uk/display?id=788>.

Region	Tele- phone	E-mail
United Kingdom (UK), EMEA, and Asia Pacific	+44 (0)1329 246 932	emea.service@raymarine.com
United States (US)	+1 (603) 324 7900	rm-usrepair@flir.com

Region	Tele- phone	E-mail
Australia and New Zealand	+61 2 8977 0300	aus.support@raymarine.com (Raymarine subsidiary)
France	+33 (0)1 46 49 72 30	support.fr@raymarine.com (Raymarine subsidiary)
Germany	+49 (0)40 237 808 0	support.de@raymarine.com (Raymarine subsidiary)
Italy	+39 02 9945 1001	support.it@raymarine.com (Raymarine subsidiary)
Spain	+34 96 2965 102	sat@azimut.es (Authorized Raymarine distributor)
Netherlands	+31 (0)26 3614 905	support.nl@raymarine.com (Raymarine subsidiary)
Sweden	+46 (0)317 633 670	support.se@raymarine.com (Raymarine subsidiary)
Finland	+358 (0)207 619 937	support.fi@raymarine.com (Raymarine subsidiary)
Norway	+47 692 64 600	support.no@raymarine.com (Raymarine subsidiary)
Denmark	+45 437 164 64	support.dk@raymarine.com (Raymarine subsidiary)
Russia	+7 495 788 0508	info@mikstmarine.ru (Authorized Raymarine distributor)

Web support

Please visit the "Support" area of the Raymarine website for:

- **Manuals and Documents** — <http://www.raymarine.com/manuals>
- **FAQ / Knowledgebase** — <http://www.raymarine.com/knowledgebase>
- **Technical support forum** — <http://forum.raymarine.com>
- **Software updates** — <http://www.raymarine.com/software>

Telephone and e-mail support

Region	Tele- phone	E-mail
United Kingdom (UK), EMEA, and Asia Pacific	+44 (0)1329 246 777	support.uk@raymarine.com
United States (US)	+1 (603) 324 7900 (Toll-free: +800 539 5539)	support@raymarine.com

Viewing product information

1. Press the **Menu** button.
2. Select **Set-up**.
3. Select **Diagnostics**.
4. Select **About Display**.
A range of information is displayed, including the software version and Serial number.
5. Use the **Up** and **Down** buttons to cycle through the information.

16.2 Learning resources

Raymarine has produced a range of learning resources to help you get the most out of your products.

Video tutorials

	<p>Raymarine official channel on YouTube:</p> <ul style="list-style-type: none">• http://www.youtube.com/user/RaymarineInc
	<p>Video Gallery:</p> <ul style="list-style-type: none">• http://www.raymarine.co.uk/view/?id=2679
	<p>Product Support videos:</p> <ul style="list-style-type: none">• http://www.raymarine.co.uk/view/?id=4952

Note:

- Viewing the videos requires a device with an Internet connection.
- Some videos are only available in English.

Training courses

Raymarine regularly runs a range of in-depth training courses to help you make the most of your products. Visit the Training section of the Raymarine website for more information:

- <http://www.raymarine.co.uk/view/?id=2372>

FAQs and Knowledge Base

Raymarine has produced an extensive set of FAQs and a Knowledge Base to help you find more information and troubleshoot any issues.

- <http://www.raymarine.co.uk/knowledgebase/>

Technical support forum

You can use the Technical support forum to ask a technical question about a Raymarine product or to find out how other customers are using their Raymarine equipment. The resource is regularly updated with contributions from Raymarine customers and staff:

- <http://forum.raymarine.com>

SWIB

Chapter 17: Spares and accessories

Chapter contents

- [17.1 Spares and Accessories on page 114](#)
- [17.2 SeaTalk^{ng}® cables and accessories on page 114](#)
- [17.3 SeaTalk^{ng} cable kits on page 116](#)
- [17.4 SeaTalk accessories on page 119](#)

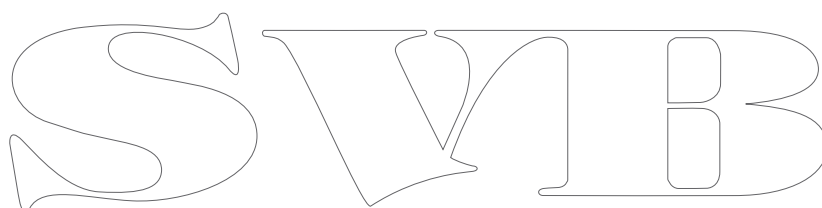

17.1 Spares and Accessories

Part number	Description	
A80353	Black bezel	i70s / p70s / p70Rs
A80354	Gunmetal bezel	i70s / p70s / p70Rs
A80357	Suncover	i70s / p70s
A80358	Suncover	p70Rs

17.2 SeaTalk^{ng}® cables and accessories

SeaTalk^{ng} cables and accessories for use with compatible products.

Description	Part No	Notes
SeaTalk ^{ng} starter kit	T70134	Includes: <ul style="list-style-type: none"> • 1 x 5 Way connector (A06064) • 2 x Backbone terminator (A06031) • 1 x 3 m (9.8 ft) spur cable (A06040) • 1 x Power cable (A06049)
SeaTalk ^{ng} Backbone Kit	A25062	Includes: <ul style="list-style-type: none"> • 2 x 5 m (16.4 ft) Backbone cable (A06036) • 1 x 20 m (65.6 ft) Backbone cable (A06037) • 4 x T-piece (A06028) • 2 x Backbone terminator (A06031) • 1 x Power cable (A06049)
SeaTalk ^{ng} 0.4 m (1.3 ft) spur	A06038	
SeaTalk ^{ng} 1 m (3.3 ft) spur	A06039	
SeaTalk ^{ng} 3 m (9.8 ft) spur	A06040	
SeaTalk ^{ng} 5 m (16.4 ft) spur	A06041	
SeaTalk ^{ng} 0.4 m (1.3 ft) elbow spur	A06042	
SeaTalk ^{ng} 0.4 m (1.3 ft) backbone	A06033	
SeaTalk ^{ng} 1 m (3.3 ft) backbone	A06034	
SeaTalk ^{ng} 3 m (9.8 ft) backbone	A06035	
SeaTalk ^{ng} 5 m (16.4 ft) backbone	A06036	
SeaTalk ^{ng} 9 m (29.5 ft) backbone	A06068	
SeaTalk ^{ng} 20 m (65.6 ft) backbone	A06037	
SeaTalk ^{ng} to bare ends 1 m (3.3 ft) spur	A06043	

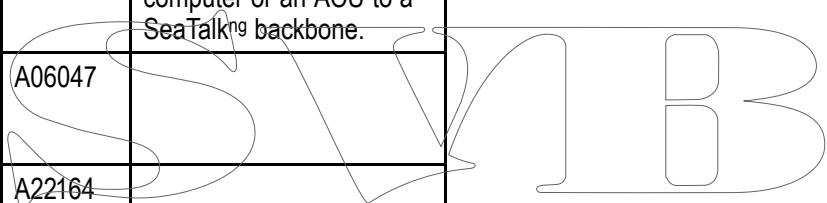

S V E B

Description	Part No	Notes
SeaTalk ^{ng} to bare ends 3 m (9.8 ft) spur	A06044	
SeaTalk ^{ng} Power cable	A06049	
SeaTalk ^{ng} Terminator	A06031	
SeaTalk ^{ng} T-piece	A06028	Provides 1 x spur connection
SeaTalk ^{ng} 5-way connector	A06064	Provides 3 x spur connections
SeaTalk ^{ng} backbone extender	A06030	
SeaTalk to SeaTalk ^{ng} converter kit	E22158	Allows the connection of SeaTalk devices to a SeaTalk ^{ng} system.
SeaTalk ^{ng} Inline terminator	A80001	Provides direct connection of a spur cable to the end of a backbone cable. No T-piece required.
SeaTalk ^{ng} Blanking plug	A06032	
ACU / SPX SeaTalk ^{ng} spur cable 0.3 m (1.0 ft)	R12112	Connects an SPX course computer or an ACU to a SeaTalk ^{ng} backbone.
SeaTalk (3 pin) to SeaTalk ^{ng} adaptor cable 0.4 m (1.3 ft)	A06047	
SeaTalk to SeaTalk ^{ng} spur 1 m (3.3 ft) spur	A22164	
SeaTalk2 (5 pin) to SeaTalk ^{ng} adaptor cable 0.4 m (1.3 ft)	A06048	
DeviceNet adaptor cable (Female)	A06045	Allows the connection of NMEA 2000 devices to a SeaTalk ^{ng} system.
DeviceNet adaptor cable (Male)	A06046	Allows the connection of NMEA 2000 devices to a SeaTalk ^{ng} system.
DeviceNet adaptor cable (Female) to bare ends.	E05026	Allows the connection of NMEA 2000 devices to a SeaTalk ^{ng} system.
DeviceNet adaptor cable (Male) to bare ends.	E05027	Allows the connection of NMEA 2000 devices to a SeaTalk ^{ng} system.





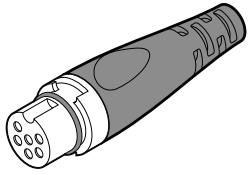

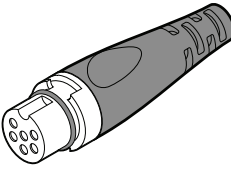
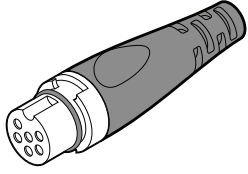
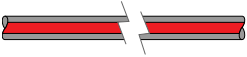
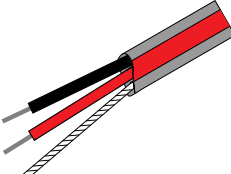
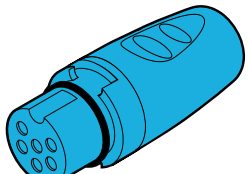
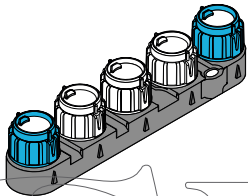
17.3 SeaTalk^{ng} cable kits

SeaTalk^{ng} starter kit (T70134)

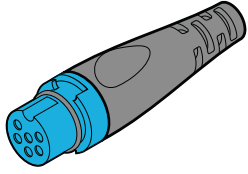
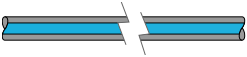
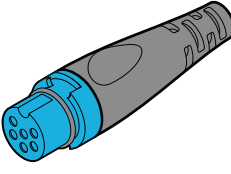
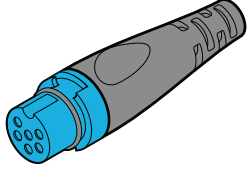
Parts included	Quantity	Connector A	Cable	Connector B	Length
Spur cable (A06040)	1				3 m (9.8 ft)
Power cable (A06049)	1				1 m (3.3 ft)
Backbone terminator (A06031)	2		N/A	N/A	N/A
5-way connector (A06064). Each connector block allows the connection of up to 3 compatible devices. When correctly terminated, a connector block forms a complete backbone. Multiple connector blocks can be daisy-chained together.	1		N/A	N/A	N/A

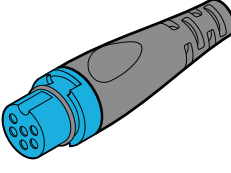
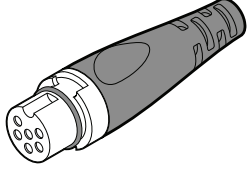
SeaTalk^{ng} Backbone kit (A25062)

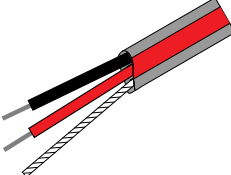
Parts included	Quantity	Connector A	Cable	Connector B	Length
Backbone cable ((A06036))	2				5 m (16.4 ft)
Backbone cable ((A06037))	1				20 m (65.6 ft)
Power cable (A06049)	1				1 m (3.3 ft)

Parts included	Quantity	Connector A	Cable	Connector B	Length
T-piece (A06028)	4		N/A	N/A	N/A
Backbone terminator (A06031)	2		N/A	N/A	N/A

SeaTalk^{ng} Evolution cable kit (R70160)

Parts included	Quantity	Connector A	Cable	Connector B	Length
Backbone cable (A06036)	2				5 m (16.4 ft)
Power cable (A06049)	1				1 m (3.3 ft)
Spur cable (A06040)	1				1 m (3.3 ft)
ACU / SPX power cable (R12112) (for powering the SeaTalk ^{ng} backbone from the autopilot system.	1				0.3 m (1.0 ft)
5-way connector (A06064). Each connector block allows the connection of up to 3 compatible devices. When correctly terminated, a connector block forms a complete backbone. Multiple connector blocks can be daisy-chained together.	1		N/A	N/A	N/A

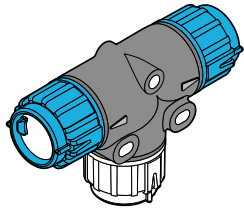
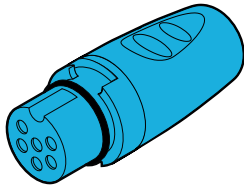
Parts included	Quantity	Connector A	Cable	Connector B	Length
T-piece (A06028)	2		N/A	N/A	N/A
Backbone terminator (A06031)	2		N/A	N/A	N/A

SeaTalk^{ng} converter kit (E22158)

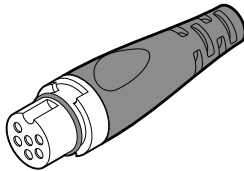
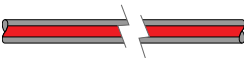
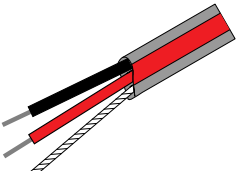
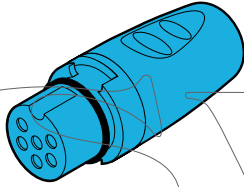
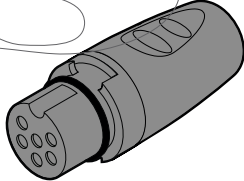
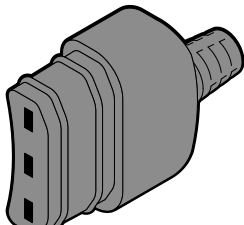
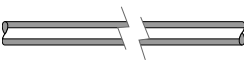
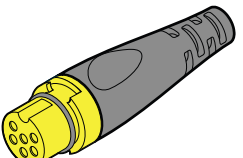
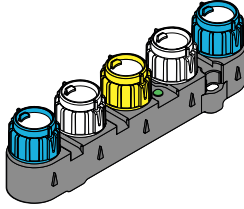
Parts included	Quantity	Connector A	Cable	Connector B	Length
Power cable (A06049)	1				1 m (3.3 ft)
Backbone terminator (A06031)	2		N/A	N/A	N/A
Blanking plug (A06032)	1		N/A	N/A	N/A
SeaTalk (3 pin) adapter cable (A06047)	1				0.4 m (1.3 ft)
SeaTalk to SeaTalk ^{ng} converter (E22158). Enables the connection of SeaTalk devices to a SeaTalk ^{ng} system.	1		N/A	N/A	N/A

17.4 SeaTalk accessories

SeaTalk cables and accessories for use with compatible products.

Description	Part No	Notes
3-way SeaTalk junction box	D244	
1 m (3.28 ft) SeaTalk extension cable	D284	
3 m (9.8 ft) SeaTalk extension cable	D285	
5 m (16.4 ft) SeaTalk extension cable	D286	
9 m (29.5 ft) SeaTalk extension cable	D287	
12 m (39.4 ft) SeaTalk extension cable	E25051	
20 m (65.6 ft) SeaTalk extension cable	D288	

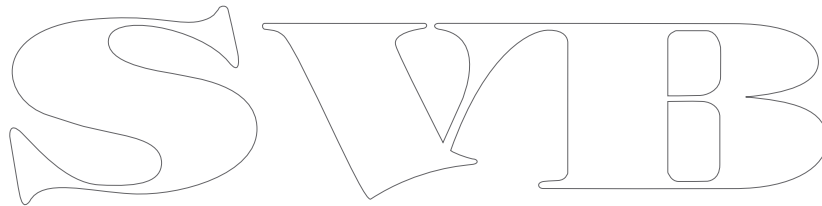
The logo consists of the letters 'S', 'W', and 'B' in a large, stylized, outlined font. The 'S' is on the left, the 'W' is in the middle, and the 'B' is on the right. The letters are interconnected and have a decorative, slightly irregular appearance.

SWIB

Appendix A Supported NMEA 2000 PGN list

PGN	Description	Received	Transmitted
59392	ISO Acknowledgment	•	•
59904	ISO Request	•	
60928	ISO Address Claim	•	•
126208	NMEA - Request group function	•	•
126464	PGN List – Receive / Transmit PGN's Group function	•	•
126992	System Time	•	•
126993	Heartbeat	•	•
126996	Product Information	•	•
127237	Heading/Track Control	•	
127245	Rudder	•	•
127250	Vessel Heading	•	
127251	Rate of Turn	•	
127257	Attitude	•	
127258	Magnetic Variation	•	•
128259	Speed	•	
128267	Water Depth (below transducer)	•	
128275	Distance Log	•	
129025	Position, Rapid Update	•	
129026	COG & SOG, Rapid Update	•	
129029	GNSS Position Data	•	
129033	Time & Date	•	
129044	Datum	•	
129283	Cross Track Error	•	
129284	Navigation Data	•	
129291	Set & Drift, Rapid Update	•	
130306	Wind Data	•	
130310	Environmental Parameters	•	
130311	Environmental Parameters	•	
130576	Small Craft Status	•	
130577	Direction Data	•	

Appendix B Software releases

Raymarine regularly updates product software to introduce improvements, additional hardware support and user interface features. The table below details some of the important enhancements and which software revision they were introduced with.

Software version	Applicable product manual	Pilot controller compatibility	Changes
V3.05	81365-2 / 88057-2 / 82285-6	p70s / p70Rs / p70 / p70R	<ul style="list-style-type: none"> Track acquisition & Track Keeping enhancements Vane mode — Wind steering performance improvements Advanced Compass linearization bar added for Evolution Improved Wind Shift alarm including ability to switch alarm off.
V2.17	81365-1 / 88057-1 / 82285-5	p70s / p70Rs / p70 / p70R	<ul style="list-style-type: none"> New Speed input selection (Auto/STW/SOG/Cruise speed) added to Autopilot Calibration menu Enhanced MDS functionality Correct truncated UI translations Compass Restart now not available when Calibration Lock is enabled.
V2.12	81355-1 / 82285-5	p70 / p70R	<ul style="list-style-type: none"> Added Rudder bar indicator to Dockside Calibration, Rudder alignment.
V2.11	81355-1 / 82285-5	p70 / p70R	<ul style="list-style-type: none"> Add support for Evolution autopilots Added new About System diagnostics page

Software version	Applicable product manual	Pilot controller compatibility	Changes
V1.08	81355-1	p70 / p70R	<ul style="list-style-type: none"> • Corrected unit reset when unit is set to Swedish • Improved compatibility on multiple control head systems
V1.06	81331-1	p70 / p70R	<ul style="list-style-type: none"> • Initial Release

SVIB

SWIB

Raymarine®

SVS100 BY FLIR®



www.raymarine.com

