



SWIB

OCEAN **air**

SKYSCREEN

Roller Surface 2

Assembly, Tensioning & Installation Instructions

Parts Diagram

Assembly instructions

Unpack SKYSCREEN using suitable implement to avoid damaging contents and lay SKYSCREEN out as shown.



Contents:
A. Blind/Fly Cassettes - 2 off
B. Side Rail - 2 off

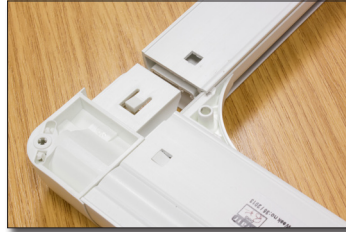

Lay cassette and side rail face down as shown. Line up and slot corner radius into side rail.

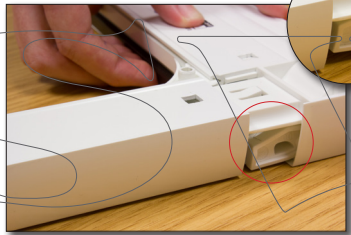

Continue to slot side rail onto corner moulding. Lift crossbar and continue to slot side rail.



Ensure side rail slots on inside of corner moulding lip.

Click !!



Side rail clips into place as shown, a definite click should be heard.



Repeat steps above for other corners. Test operation of screen.

Tensioning the Blind or Fly

The SKYSCREEN Is assembled and tested before shipping and does not need tensioning. However if tensioning is lost for any reason, please follow the steps below.

With the screen facing you, the tension adjustment is located under the right hand top screw cover



Remove screw cover and turn the SKYSCREEN over.



Un-clip the tensioner as shown. CAUTION, this will be under spring tension.

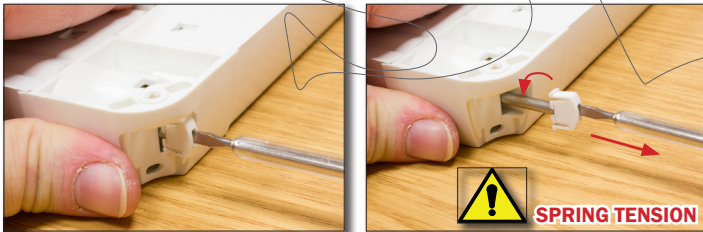

Insert screwdriver in tensioner slot and allow spring to retract from corner moulding. Spring tension will now be felt in the two directions shown.



Turn clockwise to tension or anti-clockwise to de-tension. NOTE: No more than 8 full turns should be required.

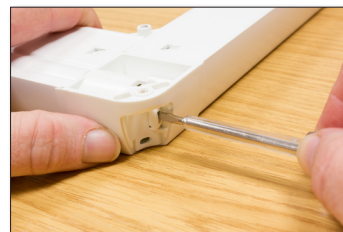

Keeping spring under tension, clip the tensioner back in to the corner moulding.

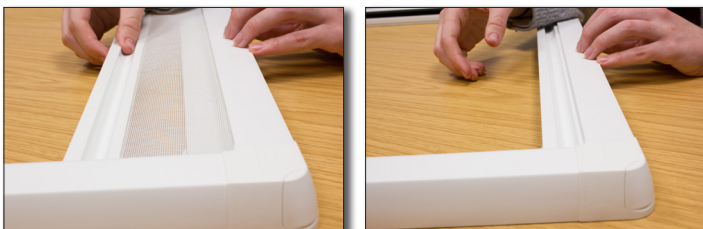

To test for sufficient tension, pull blind/fly back to the distance shown and let go. The blind should fully return smoothly without snapping back into cassette.

Installing the SKYSCREEN

Before installation

- Measure the SKYSCREEN and make sure it is the correct size.
- Make sure the unit is fitted to a flat surface to avoid forcing the unit out of shape when fixing.
- If SKYSCREEN is large; ensure a minimum of two people undertake the installation.
- Ensure that the SKYSCREEN is the correct way up and in the desired orientation.
- Make sure that the SKYSCREEN is not twisted; distortion will damage the blind and affect operation.

1

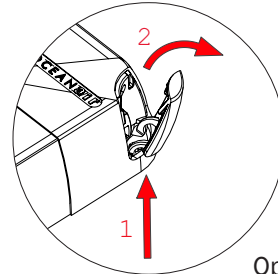
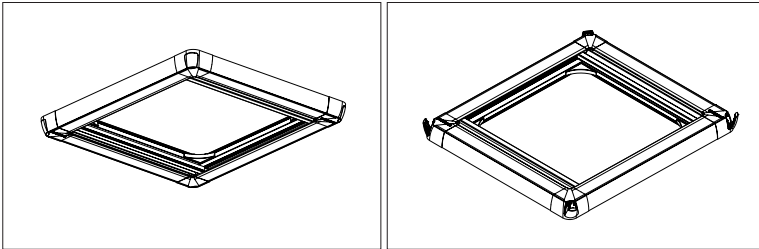

Open screw covers as shown.

2

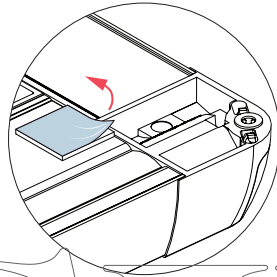
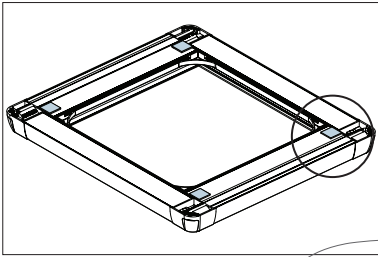

Turn over and remove protective covers from adhesive pads in each corner.

3

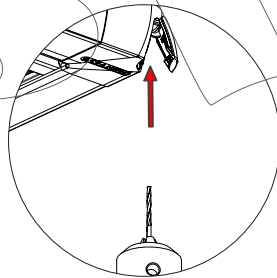
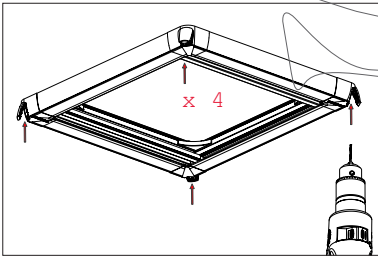

Ensuring mounting surfaces are free from dust or grease, use the adhesive pads to hold the SKYSCREEN in position and drill pilot holes. Ensure that the thickness of the boat structure at the proposed mounting position is deep enough to prevent the fixing screws from breaking through. Oceanair recommend No6 x 16mm [5/8"] PANHEAD Screws (not provided). However if necessary, use shorter fixing screws and use masking tape on the drill bit as a depth guide to avoid drilling too deep.

4

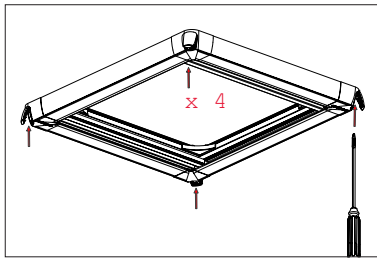
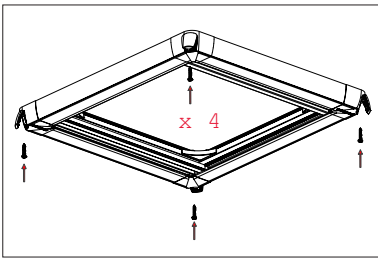

Insert and tighten screws in each corner using screwdriver, **do not use electric screwdriver.**

Note:

If the screen is to be fitted on to a soft headlining, we recommend the use of M4 plastic washers (not supplied) to shim between the screen and headlining. This will help to avoid distortion of the frame and over compressing the headlining material.

5

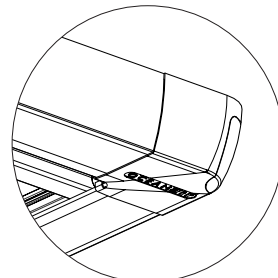
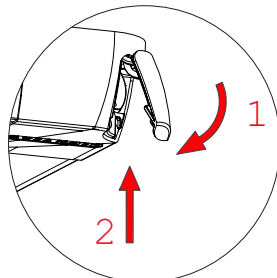
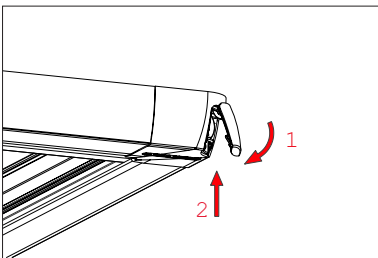

Close screw covers.

6

Check operation of SKYSCREEN.

SKYSCREEN Roller Surface Mk3 Parts Diagram

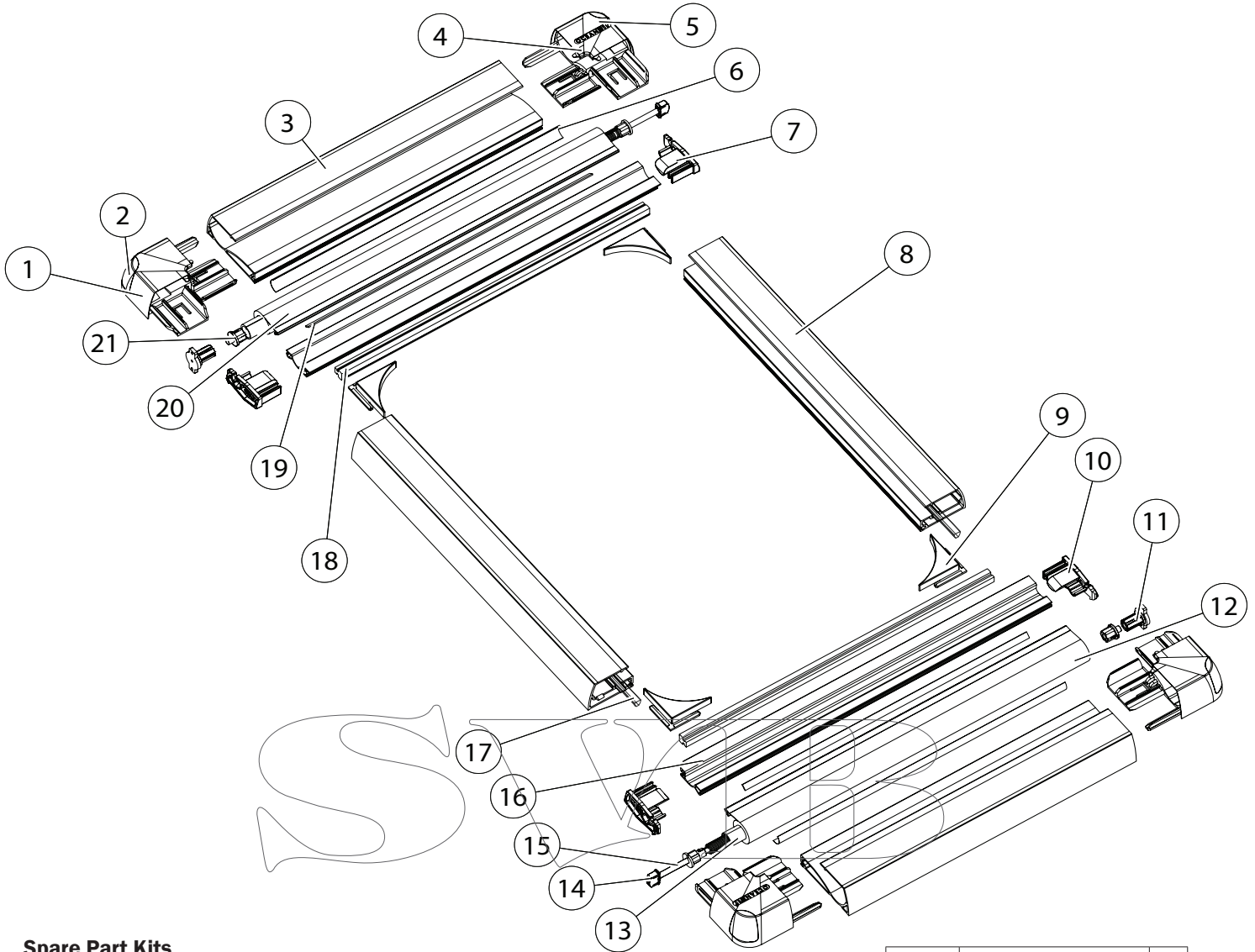

Spare Part Kits Blind assembly

Oceanair Kit Part No.	Kit Description	Item No's
AC-SRS-**-BLINDASS+XB	With crossbar	6, 7, 10, 13, 14, 15, 16, 19, 21 or 11
AC-SRS-**-BLINDASS	Without crossbar	6, 13, 14, 15, 19, 21 or 11

** Replace with X/Y dimensions of screen

Fly assembly

Oceanair Kit Part No.	Kit Description	Item No's
AC-SRS-**-FLYASS+XB	With crossbar	6, 7, 10, 12, 13, 14, 15, 16, 21 or 11
AC-SRS-**-FLYASS	Without crossbar	6, 12, 13, 14, 15, 21 or 11

** Replace with X/Y dimensions of screen

Corner mouldings

Oceanair Kit Part No.	Kit Description	Item No's
AC-SRS-CORNER CAP-W/B *4	Corner moulding Kit white or beige	1 - 2 off, 4 - 2 off

Screw covers

Oceanair Kit Part No.	Kit Description	Item No's
AC-SRS-SCREWCAP-W/B *4	Corner moulding screw cover white or beige	2 - 2 off, 5 - 2 off

BOM ID	Description	Qty
1	LH Corner moulding	2
2	LH Screw cover	2
3	Roller Cover	2
4	RH Corner moulding	2
5	RH Screw cover	2
6	Double sided tape	2
7	RH Crossbar end cap	2
8	Side rail	2
9	Corner radius	4
10	LH Crossbar end cap	2
11	Damper unit (optional)	2
12	Fly fabric	1
13	Roller	2
14	Tensioner	2
15	Spring A	2
16	Crossbar	2
17	Brush strip	2
18	Magnetic Strip	2
19	Edge strip	1
20	Blackout fabric	2
21	Idler bearing (optional)	2

Notes

SWIB

Notes

SWIB

SWIB

OCEANair

Elegance : Engineered

Oceanair Marine Ltd.

Atlantic House, 1 Ellis Square, Selsey, Chichester PO20 0AY United Kingdom.

Tel: +44 1243 606909 Fax: +44 1243 608300 www.oceanair.co.uk



Registered Office

Atlantic House, 1 Ellis Square, Selsey, Chichester PO20 0AY
Registered in England No. 2504633
A member of the British Marine Federation

© Oceanair Marine Ltd 2013

Part No. 70000288 Rev 2 ECN 11753 November 2014