

Hatch & Portlight Fitting Guide

LEWMAR®

www.lewmar.com

Introduction

Fitting a new or replacement hatch or portlight can be a simple and rewarding procedure. By following these clear instructions you will be able to complete the job easily. But remember the most important part of fitting a new hatch or portlight is forward planning.

Before you order your hatch or portlight, you need to make some straightforward measurements. When replacing an old hatch or portlight, carefully measure the old hatch and aperture. You then have the information to hand when selecting your replacement hatch/portlight.

When you are replacing an older Lewmar hatch or portlight and you would like to find a direct replacement, please note that although the Lewmar standard cut out sizes have remained constant, the corner radius may have changed on certain models. If you cannot match up a new hatch or portlight with the existing range of cut outs, the only solution may be to build an intermediate frame from timber.

If you are selecting a location for a new hatch or portlight you must make sure the surface is flat with a maximum tolerance of +/- 1mm. You should also consider that if you are fitting a new hatch or portlight, cutting a hole in your boat might compromise the structural integrity of the boat. Hatches and portlights should not be considered as stiffening members and it is recommended that the deck be adequately stiffened to prevent distortion during heavy weather. If you have any doubts about the location you are going to place the hatch or portlight, you should consult a yacht designer or surveyor.

ABS plastic and aluminium trimkits are available, making the interior installation easy and stylish. The kit comes complete with fly screen.



ABS Plastic Trimkit



Roller Shade/Screen

This guide will help you choose a particular hatch or portlight, however you will have to take time and read the hatch and portlight location guidelines in this booklet, as CE regulations stipulate where certain products may be fitted.

With this simple well illustrated guide, choosing your hatch or portlight is easy. Don't forget that the most important part of the task is not fitting the hatch, but planning the job well and having the correct tools to hand.

What Hatch?

To replace any of your craft's existing hatches or undertake a retrofit installation, Lewmar offers a comprehensive range of sizes. Available in Low Profile, Medium Profile and Ocean ranges.

Low Profile Hatch

Figure 1

The Low Profile hatches have soft styling and sleek looks. They are ideal for use on power craft. The smaller ventilation hatches are suitable for any deck location on sail boats and the larger hatches can be used as foredeck hatches on small to mid size yachts. The hatch also features Lewmar's unique sealing system allowing easy acrylic replacement.



Figure 1

Medium Profile Hatch

Figure 2

The Medium Profile hatch has identical styling to the Low Profile hatch while providing greater strength as a result of thicker acrylic and deeper frame sections. This product is ideal on the foredeck of larger offshore yachts. The hatch also features Lewmar's unique sealing system allowing easy acrylic replacement.



Figure 2

Ocean Hatch

Figure 3

The Ocean hatch has a classical styling and rugged construction for ultimate protection against the elements. Lewmar's Ocean hatches are fitted to thousands of boats throughout the world.

Figure 3



Roller Shade/Screen

Figure 4 to 7

The new Roller Shade/Screen is a tough multi-functional hatch accessory which features an integral blind and flyscreen. The new Roller Shade/Screen allows trickle ventilation, and has an easy to install trim system for all types of sailing and motor yachts fitted with standard Lewmar hatches.

Figure 4

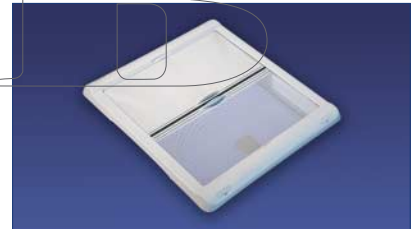

Figure 5



Figure 6



Figure 7



Hatches with this icon feature Lewmar's unique sealing system which allows easy replacement of the acrylic lens by simply sliding the two halves of the frame apart.

What Portlight?

Standard Portlight

Figure 8

The Standard Portlight is ideal for the cruising boat and is competitively priced. The range is stylish, easy to use and simple to install. It is an ideal replacement for the older standard portlights.



Figure 8

Atlantic Portlight

Figure 9

Atlantic Portlights are well styled with clean lines and clear vision through the window. The acrylic window has an aluminium frame making the hatch very reliable, qualifying for CE area 1 (in hull) between size 10 and 32.



Figure 9

Stainless Portlight

Figure 10

The Stainless Portlight features a highly polished stainless outer frame with a mirror finish quality. The handles and hinge systems are from the Standard Portlight and leave the lens free from obstructions for a cleaner look.

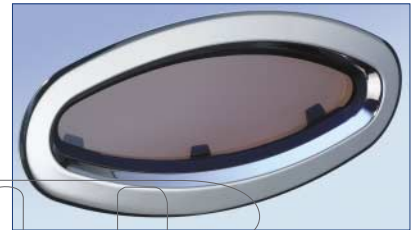
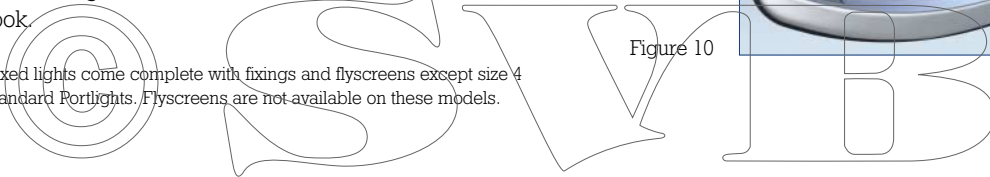

Figure 10

All portlights and fixed lights come complete with fixings and flyscreens except size 4 left & right hand Standard Portlights. Flyscreens are not available on these models.



All product complies with relevant parts of International Standards ISO/DIS 12216.2(E)

Approved This standard covers the applicable essential safety requirements of the Recreational Craft Directive 94/25EC.

Please refer to inside rear cover.

Hatch & Portlight Specifications & Dimensions

Part No	Size	Overall Size								Cut-Out Size Dimensions change if Trimkits are used					
		Lower Frame Flange		X Length	Y Width	Z Height	R Radii	X1 Cut-Out Length	Y1 Cut-Out Width	R1 Cut-Out Radii					
		mm	in	mm	in	mm	in	mm	in	mm	in	mm	in	mm	in

The specification charts below provide cut out dimensions for standard Medium & Low Profile Hatches and Portlights.

Low Profile Hatch

39900030	00	15	9/16	281	1 11/16	281	1 11/16	25	1	77.5	3 1/16	211	8 5/16	211	8 5/16	42.5	1 11/16
39903030	03	15	9/16	246	9 11/16	301	11 7/8	25	1	77.5	3 1/16	176	6 15/16	231	9 1/8	42.5	1 11/16
39910030	10	15	9/16	330	12	330	12	25	1	77.5	3 1/16	260	10 1/4	260	10 1/4	42.5	1 11/16
39920030	20	15	9/16	272	10 11/16	417	16 7/16	25	1	77.5	3 1/16	202	7 15/16	347	13 11/16	42.5	1 11/16
39930030	30	15	9/16	397	15 5/8	527	20 3/4	25	1	77.5	3 1/16	327	12 7/8	457	18	42.5	1 11/16
39940030	40	15	9/16	491	19 5/16	491	19 5/16	25	1	77.5	3 1/16	421	16 9/16	421	16 9/16	42.5	1 11/16
39941030*	41	15	9/16	246	9 11/16	491	19 5/16	25	1	77.5	3 1/16	176	6 15/16	421	16 9/16	42.5	1 11/16
39944030	44	15	9/16	512	20 3/16	512	20 3/16	25	1	77.5	3 1/16	442	17 3/8	442	17 3/8	42.5	1 11/16
39950030	50	15	9/16	447	17 5/8	577	22 11/16	25	1	77.5	3 1/16	377	14 13/16	507	19 15/16	42.5	1 11/16
39954030	54	15	9/16	462	18 3/16	577	22 11/16	25	1	77.5	3 1/16	392	15 7/16	507	19 15/16	42.5	1 11/16
39960030	60	15	9/16	577	22 11/16	577	22 11/16	25	1	77.5	3 1/16	507	19 15/16	507	19 15/16	42.5	1 11/16
39965030*	65	15	9/16	560	22 1/16	675 [†]	26 9/16 [†]	560 [†]	22 1/16 [†]	25	1	77.5	3 1/16	See Drawing Above		42.5	1 11/16

• Hatches should be fitted to a flat surface with a maximum tolerance of ± 1mm. • Fastening size at the hinge section use M6 (1/4") bolts. • Fastening size for lower frame section use 5mm CSK screw No. 10 UNC 2BA. • Backing plate part number 360061909 (M6) or 360062909 (1/4"). *Part No's marked with a * are made to order. [†]Maximum Width. [‡]Minimum Width.

Medium Profile Hatch

39930020	30	15	9/16	397	15 5/8	527	20 3/4	32	1 1/4	78	3 1/16	327	12 7/8	457	18	42.5	1 11/16
39940020	40	15	9/16	492	19 3/8	492	9 3/8	32	1 1/4	78	3 1/16	421	16 9/16	421	16 9/16	42.5	1 11/16
39944020	44	15	9/16	513	20 3/16	513	20 3/16	32	1 1/4	78	3 1/16	442	17 3/8	442	17 3/8	42.5	1 11/16
39950020	50	15	9/16	448	17 5/8	578	22 3/4	32	1 1/4	78	3 1/16	377	14 13/16	507	19 15/16	42.5	1 11/16
39954020	54	15	9/16	463	18 1/4	578	22 3/4	32	1 1/4	78	3 1/16	392	15 7/16	507	19 15/16	42.5	1 11/16
39960020	60	15	9/16	578	22 3/4	578	22 3/4	32	1 1/4	78	3 1/16	507	19 15/16	507	19 15/16	42.5	1 11/16
39970020	70	15	9/16	698	27 1/2	698	27 1/2	32	1 1/4	78	3 1/16	627	24 11/16	627	24 11/16	42.5	1 11/16
39977020*	77	15	9/16	770	30 5/16	770	30 5/16	32	1 1/4	78	3 1/16	699	27 1/2	699	27 1/2	42.5	1 11/16

Ocean Hatch

39600050*	0	Flat Base		275	10 13/16	275	10 13/16	39.5	1 9/16	69	2 11/16	201	7 15/16	201	7 15/16	34	1 5/16
39600070*		25	1									206	8 1/8	206	8 1/8	36.5	1 7/16
39610050	10	Flat Base		324	12 3/4	324	12 3/4	39.5	1 9/16	75	2 15/16	255	10 1/16	255	10 1/16	40	1 9/16
39610070		25	1									260	10 1/4	260	10 1/4	42.5	1 11/16
39620050	20	Flat Base		266	10 1/2	411	16 3/16	39.5	1 9/16	69	2 11/16	197	7 3/4	342	13 7/16	34	1 5/16
39620070		25	1									202	7 15/16	347	13 11/16	36.5	1 7/16
39630050	30	Flat Base		391	15 3/8	521	20 1/2	39.5	1 9/16	75	2 15/16	322	12 11/16	452	17 13/16	40	1 9/16
39630070		25	1									327	12 7/8	457	18	42.5	1 11/16
39640050	40	Flat Base		485	19 1/8	485	19 1/8	39.5	1 9/16	75	2 15/16	416	16 3/8	416	16 3/8	40	1 9/16
39640070		25	1									421	16 9/16	421	16 9/16	42.5	1 11/16
39644050	44	Flat Base		509	20 1/16	509	20 1/16	43	1 11/16	76	3	437	17 3/16	437	17 3/16	40	1 9/16
39644070		25	1									442	17 3/8	442	17 3/8	42.5	1 11/16
39650050	50	Flat Base		444	17 1/2	574	22 5/8	43	1 11/16	76	3	372	14 5/8	502	19 3/4	40	1 9/16
39650070		25	1									377	14 13/16	507	19 15/16	42.5	1 11/16
39654050	54	Flat Base		459	18 1/16	574	22 5/8	43	1 11/16	76	3	387	15 1/4	502	19 3/4	40	1 9/16
39654070		25	1									392	15 7/8	507	19 15/16	42.5	1 11/16
39660050	60	Flat Base		574	22 5/8	574	22 5/8	43	1 11/16	76	3	502	19 3/4	502	19 3/4	40	1 9/16
39660070		25	1									507	19 15/16	507	19 15/16	42.5	1 11/16
39670050	70	Flat Base		694	27 5/16	694	27 5/16	43	1 11/16	76	3	622	24 1/2	622	24 1/2	40	1 9/16
39670070		25	1									627	24 11/16	627	24 11/16	42.5	1 11/16
39677050	77	Flat Base		767	30 3/16	767	30 3/16	43	1 11/16	76	3	694	27 5/16	694	27 5/16	40	1 9/16
39677070		25	1									699	27 1/2	699	27 1/2	42.5	1 11/16

Hatch Dimensions

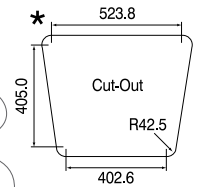
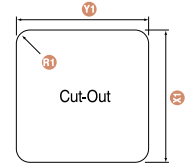
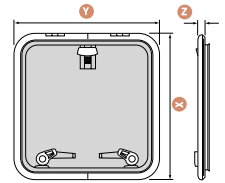

Using a Compass to Radius a Corner

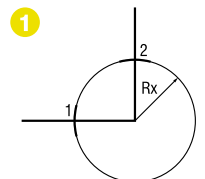

Set compass to radius

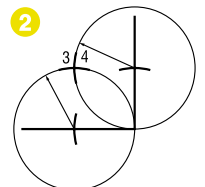

Keeping compass setting constant

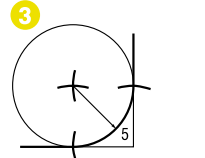

After setting do not adjust

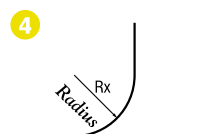

Part No	Size	Version	Overall Size				Cut-Out Size Dimensions change if Trimkits are used								
			X	Y	Z	R	X1	Y1	R1	Cut-Out Width		Cut-Out Length		Cut-Out Radii	
			mm	in	mm	in	mm	in	mm	in	mm	in	mm	in	mm

Standard Portlight

393020200'	0	Opening	176	6 ¹⁵ / ₁₆	323	12 ¹¹ / ₁₆	4	5/32	62	2 ⁷ / ₁₆	156	6 ¹ / ₈	303	11 ¹⁵ / ₁₆	52	2 ¹ / ₁₆
393120200	1	Opening	191	7 ¹ / ₂	367	14 ⁷ / ₁₆	4	5/32	62	2 ⁷ / ₁₆	171	6 ³ / ₄	347	13 ⁵ / ₈	52	2 ¹ / ₁₆
393180200	1RE	Opening	191	7 ¹ / ₂	367	14 ⁷ / ₁₆	4	5/32	95	3 ³ / ₄	171	6 ³ / ₄	347	13 ⁵ / ₈	85.5	3 ³ / ₈
393220200	2	Opening	176	6 ¹⁵ / ₁₆	425	16 ³ / ₄	4	5/32	62	2 ⁷ / ₁₆	156	6 ¹ / ₈	405	15 ¹⁵ / ₁₆	52	2 ¹ / ₁₆
393320200	3	Opening	191	7 ¹ / ₂	449	17 ¹¹ / ₁₆	4	5/32	62	2 ⁷ / ₁₆	171	6 ³ / ₄	429	16 ⁷ / ₈	52	2 ¹ / ₁₆
393420200	4	Opening	191	7 ¹ / ₂	646	25 ⁷ / ₁₆	4	5/32	62	2 ⁷ / ₁₆	171	6 ³ / ₄	627	24 ¹¹ / ₁₆	52	2 ¹ / ₁₆
393460200*	4L	Opening	195	7 ¹¹ / ₁₆	708	27 ⁷ / ₈	4	5/32	62	2 ⁷ / ₁₆	175	6 ⁷ / ₈	688	27 ¹ / ₁₆	52	2 ¹ / ₁₆
393440200*	4R	Opening	195	7 ¹¹ / ₁₆	708	27 ⁷ / ₈	4	5/32	62	2 ⁷ / ₁₆	175	6 ⁷ / ₈	688	27 ¹ / ₁₆	52	2 ¹ / ₁₆
393520200	5	Opening	264	10 ³ / ₈	449	17 ¹¹ / ₁₆	4	5/32	62	2 ⁷ / ₁₆	244	9 ⁵ / ₈	429	16 ⁷ / ₈	52	2 ¹ / ₁₆
393780200*	7RE	Opening	191	7 ¹ / ₂	425	16 ³ / ₄	4	5/32	95.5	3 ³ / ₄	171	6 ³ / ₄	405	15 ¹³ / ₁₆	85.5	3 ³ / ₈

Portlight Dimensions

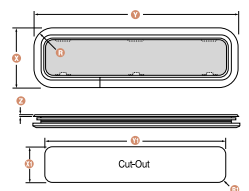

Atlantic Portlight

39110090	10	Opening	174	6 ⁷ / ₈	304	12	6	1/4	71	2 ¹³ / ₁₆	154	6 ¹ / ₁₆	284	11 ³ / ₁₆	61	2 ³ / ₈
39130090	30	Opening	200	7 ⁷ / ₈	400	15 ³ / ₄	6	1/4	71	2 ¹³ / ₁₆	180	7 ¹ / ₁₆	380	14 ¹⁵ / ₁₆	61	2 ³ / ₈
39132090	32	Opening	200	7 ⁷ / ₈	400	15 ³ / ₄	6	1/4	100	3 ¹⁵ / ₁₆	180	7 ¹ / ₁₆	380	14 ¹⁵ / ₁₆	90	3 ⁹ / ₁₆
39140090*	40	Opening	200	7 ⁷ / ₈	480	18 ⁷ / ₈	6	1/4	71	2 ¹³ / ₁₆	180	7 ¹ / ₁₆	460	18 ¹ / ₈	61	2 ³ / ₈
39160090*	60	Opening	200	7 ⁷ / ₈	600	23 ⁵ / ₈	6	1/4	71	2 ¹³ / ₁₆	180	7 ¹ / ₁₆	580	22 ¹³ / ₁₆	61	2 ³ / ₈

Stainless Portlight

393820862	8	Opening	196	7 ¹¹ / ₁₆	452	17 ¹³ / ₁₆	1.5	1/16	n/a	n/a						
-----------	----------	---------	-----	---------------------------------	-----	----------------------------------	-----	------	-----	-----	--	--	--	--	--	--

• All Portlights are supplied complete with 12 off M6-25mm screws (hull thickness 17-25mm). • Maximum hull thickness 34mm (1 3/8 in), minimum hull thickness 7mm (1/4 in). • Portlights should be fitted to a flat surface with a tolerance ± 1mm. • Clear acrylic and fixed Portlights are available – please refer to our website (www.lewmar.com). * Part No's marked with a * are made to order. Ivory trim part numbers end with 500 as opposed to 200 for white trim.

Stainless Dimensions

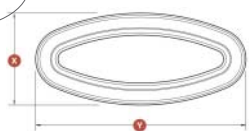

Roller Shade/Screen for Hatches

Hatch Size	Trim & Roller Screen Together	Trim Only (for roller screen)	Roller Screen Only	A	B		
				Length mm	in	Width mm	in
10	367710252	368710252	367710972	398	15 ¹¹ / ₁₆	345	13 ⁹ / ₁₆
20	367720252	368720252	367720972	340	13 ³ / ₈	432	17
30	367730252	368730252	367730972	465	18 ⁵ / ₁₆	542	21 ⁵ / ₁₆
40	367740252	368740252	367740972	559	22	506	19 ¹⁵ / ₁₆
44	367744252	368744252	367744972	580	22 ¹³ / ₁₆	528	20 ¹³ / ₁₆
50	367750252	368750252	367750972	515	20 ¹ / ₄	592	23 ⁵ / ₁₆
54	367754252	368754252	367754972	531	20 ⁷ / ₈	592	23 ⁵ / ₁₆
60	367760252	368760252	367760972	645	25 ³ / ₈	592	23 ⁵ / ₁₆
70	367770252	368770252	367770972	765	30 ¹ / ₈	712	28

Roller Shade/Screen Dimensions

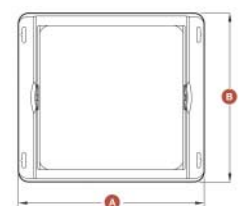

Cross Section of Roller Shade/Screen



Hatch & Portlight Installation Check List

The following checklist takes into account all the issues normally encountered when planning a hatch or portlight installation.

General

Hatches and portlights should be fitted to a flat surface with maximum tolerance of +/- 1mm. For decks of composite construction (e.g. GRP) it is recommended that the exposed laminate be sealed with the appropriate material prior to fitting the hatch. Openings in metal decks should have all burrs and sharp edges removed. It is recommended that the lower frame of the hatch is suitably insulated from the deck if there is a possibility of electrolytic corrosion with the aluminium frame of the hatch. Hatches and portlights should not be considered as stiffening members and it is recommended that the deck be adequately stiffened to prevent distortion during heavy weather. Cutting holes in the deck and hull can compromise the structural integrity of the boat. If in doubt, consult a competent yacht designer or surveyor.

Portlights

Figure 1

Portlights have a maximum and minimum deck thickness to which they may be fitted. Portlights fitted to hulls approaching the maximum deck thickness may have restricted opening. Portlights require different fastenings to suit different deck thicknesses. If the fastenings supplied with the portlight do not suit your hull thickness it will be necessary to order the required fastenings separately.

Figure 1



Hatches

Figure 2

Hatches should not be opened and closed more than necessary until the lower frame has been securely mounted to the deck. Hatches may be fitted to decks of any thickness. However, on thinner decks the flange in the lower frame may intrude into the cabin. If a Trimkit is being fitted the size of the hole cut out in the boat must be increased by 3mm. Hatch lids have to be opened past 90° in order to fasten the hatch to the deck. If an obstruction stops the hatch opening this far it will not be possible to fit it. When a hatch is fully open the lid should come to rest so that it is supported near the edge with the handles. If this is not the case, and the lid is supported near the hinges, the leverage on the lid may cause the hatch to be damaged.

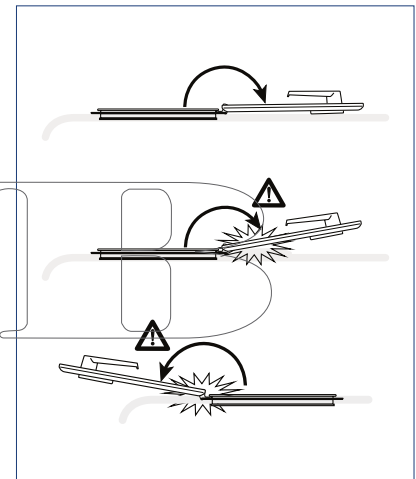

Figure 2

Tools/Consumables Checklist

- Bedding compound and application gun (silicone)
- Fastenings (supplied with portlights)
- Power drill and set of drill bits
- Jig saw
- Screwdrivers, Allen keys, spanners depending on product
- Compass (for making hatch radii)
- Felt tip pen
- Ruler



Hatch Fitting Instructions

Removal of Existing Hatch

To alleviate delamination and associated damage to the deck, great care should be taken when removing the lower frame.

Figure 1

Make a bridge of wood over the corner of the hatch frame. Take care to protect the deck by placing cardboard or carpet under the feet of the bridge. Place a second piece of wood under the boat's inside hatch frame, across the same corner as the bridge. It may be necessary to make a mitre joint in the second piece of wood to ensure contact is only made with the hatch's lower frame.

Figure 2

Use a G clamp to pull the second piece of wood upwards towards the bridge. This will start to lift the lower frame off the deck.

Figure 3

As soon as the frame has lifted by a few millimetres use a sharp, thin bladed knife to cut the bedding compound between the frame and deck. Prior to fitting the new hatch ensure all the old sealant has been removed and the old fastening holes have been filled.

Retro Hatch Fitting – Mark the Cut Out

Before marking up the hatch cut out area ensure it is being fitted to a flat surface (+/- 1mm).

Figure 4

Mark the cut out dimensions of the hatch onto the deck. Remember, if a trim is being fitted it will be necessary to increase the cut out by the amount stated. To mark up the hatch's corners follow the "How to radius a corner" instructions on Page 5.

Figure 5

Offer the hatch up to the marked out dimensions to check accuracy.

Cut & Drill

Take care to avoid any power cables, gas pipes or other services. Please ensure that you use the appropriate safety equipment such as electrical power breakers and safety glasses.

Figure 6

Drill a hole for the jigsaw blade on the waste side of the cut line.

Figure 7

Use a jigsaw to cut the aperture through the boat. It may be necessary to cut or remove the headlining.

Figure 8

Alternatively, a hole cutter that matches the corner radii may be used to cut the corners.

Fitting Instructions continue on the next page.



Figure 1



Figure 2



Figure 3



Figure 4



Figure 5



Figure 6



Figure 7



Figure 8

Figure 9

Test fit the hatch before applying sealant.



Figure 9

Figure 10

While the hatch is in place mark the lower frame fixing holes.



Figure 10

Figure 11

With the hatch removed from the deck drill all fastening holes. The hinges should be through bolted while self-tapping screws can be used for fitting the remainder of the frame.



Figure 11

Bed Down & Seal

When you are entirely happy with the installation of the hatch. Apply a generous bead of bedding compound all the way around the frame where it is in contact with the deck.

Figure 12

Apply sealant to both sides of the fastening holes on the hatch frame. If replacing an existing hatch, fill any old fixing holes with sealant.



Figure 12

Figure 13

Refit the hatch to the deck. Around the hatch frame a small amount of bedding compound should be forced out of the gap between the frame and deck. Fasten the lower frame to the deck.



Figure 13

Figure 14

The hatch should be through bolted in the hinge areas, while self-tapping screws can be used for fitting the remainder of the lower frame to the deck sheet.



Figure 14

Figure 15

Clean up excess bedding compound.



Figure 15

Figure 16

Finished hatch installation.



Figure 16

Portlight Fitting Instructions

Mark the Cut Out

Figure 1

Cut out the template provided and check it is accurate by placing it over the back of the portlight. Portlights should be fitted to a flat surface (+/- 1mm.) Tape the template to the boat and mark the cut line.

Cut & Drill

Take care to avoid any power cables, gas pipes or other services. Please ensure that you use the appropriate safety equipment such as electrical power breakers and safety glasses.

Figure 2

Drill a hole for the jigsaw blade on the waste side of the cut line.

Figure 3

Use the jigsaw to cut the aperture through the boat.

Figure 4

It may be necessary to cut or remove the headlining.

Test Fit

Figure 5

Portlights are fitted by clamping the outer frame against the deck using the inner frame inside the boat.

Figure 6

Test fit the portlight and clamp ring before applying sealant.

Fitting Instructions continue on the next page.



Figure 1



Figure 2



Figure 3



Figure 4



Figure 5



Figure 6

Bed Down & Seal

If you are replacing an old portlight, fill any old fixing holes with sealant.

Figure 7

When you are entirely happy with the installation of the portlight, remove and set it aside. Apply a generous bead of bedding compound all the way around the frame where it is in contact with the deck.



Figure 7

Figure 8

Refit the portlight to the boat. A small amount of bedding compound should be forced out of the gap between the frame and the deck the whole way round the frame.



Figure 8

Figure 9

Clamp the outer frame to the inner frame with the fixings enclosed. Ensure the fixing threads are greased.



Figure 9

Figure 10

Clean up the excess bedding compound.



Figure 10

Figure 11

Finished portlight installation.



Figure 11

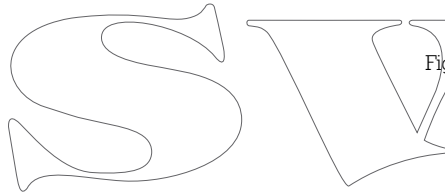
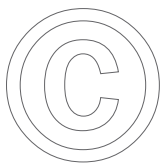

Hatch Vent Fitting Instructions

Key Features:

- Fits to hatch or deck*.
- Styled to match the Low & Medium Profile hatches.
- Captive bung – it can't be lost.
- Fits deck thickness to 100mm*.
- CE Approved and leak tested.
- No sealant required.

* Trim not included for deck fitting.

Figure 1 & 2

When cutting or drilling acrylic it is necessary to come in from both sides. Drilling or cutting all the way through will result in the acrylic breaking out when the cutter comes through.

Drilling and Cutting

Figure 3

Tape the vent template to the hatch ensuring it is clear of all handles, stays etc.

Figure 4

Drill a pilot hole for the hole saw.

Figure 5 & 6

Cut the hole in from both sides using an 80mm (3") hole saw. Take care to support the hatch lid and to protect the deck when drilling the underside of the hatch lid.

Figure 7

Drill pilot holes for fastenings.

Figure 8

Drill 6mm (1/4") fastening holes from both sides. Take care to support the hatch lid and to protect the deck when drilling the underside of the hatch lid.

Assembly & Fastening

Figure 9

Assemble ventilator with internal parts, o-rings and seal all in place.

Figure 10

Fit to the hatch.

Figure 11

Fasten from the inside.

Figure 12

Finished vent installation.

Figure 13

The vent may also be fitted to decks. Blanked out top down fastening holes are included and may be broken through if required. When top down fastening, use sealant to seal the screw holes. It will be necessary to use fixings other than those supplied. A trim is available on part number 361042992.

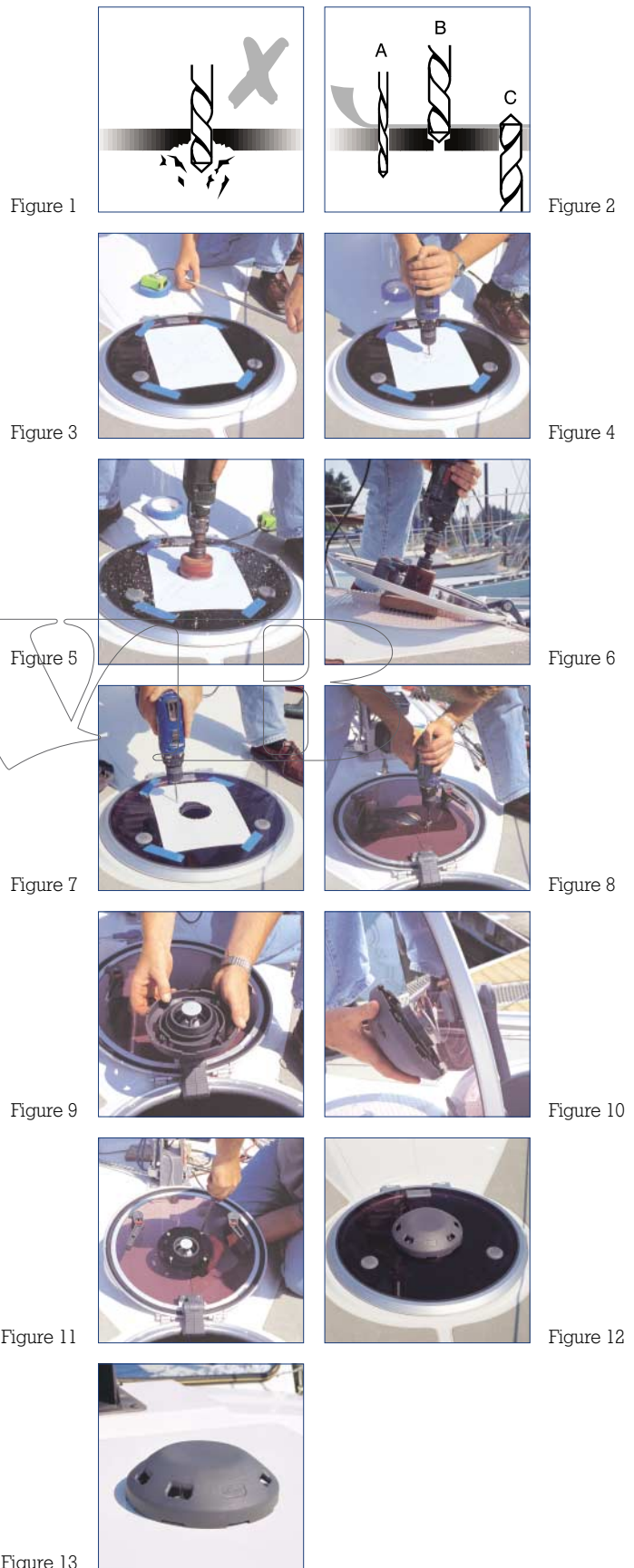

Regulations

CE Areas

CE Area 1

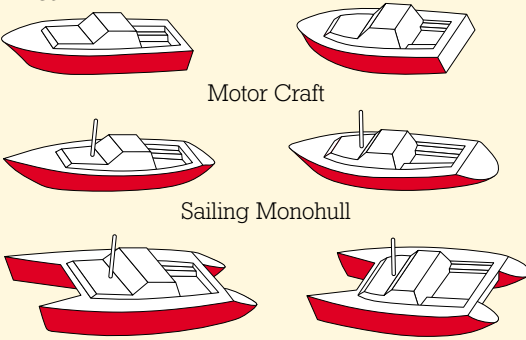

Motor Craft

Sailing Monohull

Sailing Multihull

Area 1:
"Part of the hull sides situated above the waterline"

CE Area 2

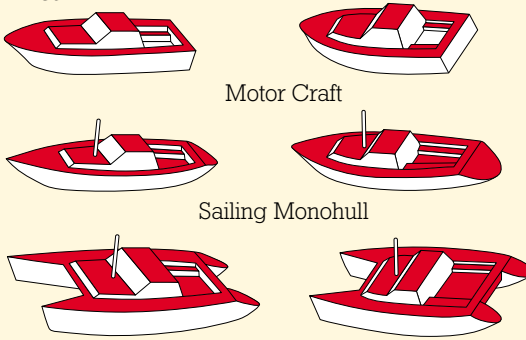

Motor Craft

Sailing Monohull

Sailing Multihull

Area 2:
"Area, other than Area 1 where persons are liable to walk or step"

CE Area 3

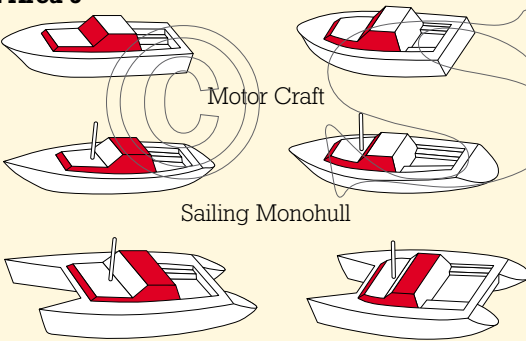

Motor Craft

Sailing Monohull

Sailing Multihull

Area 3:
"Area other than Area 1 or 2, for example Superstructures"

CE Area 4

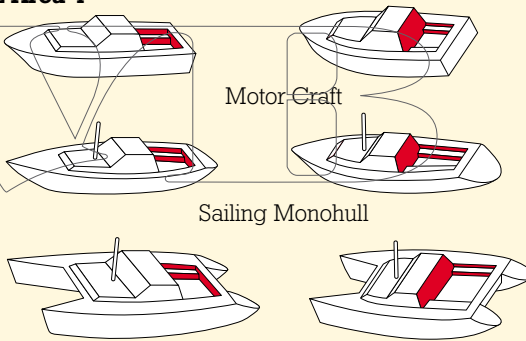

Motor Craft

Sailing Monohull

Sailing Multihull

Area 4:
"Parts of Area 3 protected from the direct impact of sea or slamming waves, for example cockpit sides and rear faces of Superstructures"

These drawings are notes for guidance only, when specifying a boat please consult the full regulations.

CE Approval

The CE Regulations apply to craft up to 24m in length, which are sold in the European Union. Although the regulations may not apply to your boat, they are a useful guide for small craft throughout the world.

Lewmar warranties are invalid if the product is installed in an area where it was not intended, and if the installation fails to meet the requirements of the CE regulations.

The Regulations divide up the boats hull and deck into four specific "Areas". A product, which is suitable for fitting to an area for which it is approved, is suitable for all the areas below its category. For example, a portlight, which is approved for Area 2 may also be fitted to Areas 3 and 4, but not Area 1.

All the hatches and portlights in this publication are CE Approved for the areas for which they are shown on the product pages. NB: For craft with a freeboard greater than 1/12 of their overall length, a different upper limit applies to Area 1. Please refer to the recreational craft directive 94/25/EC.

Hatches

Description	Sizes	Area
Low Profile Hatch	All	2
Medium Profile Hatch	All	2
Ocean Hatch	All	2

For more details on the CE Regulations, please refer to the recreational craft directive 94/25/EC.

Portlights

Description	Sizes	Area
Standard Portlights Fixed	0, 1, 1RE & 2	1
Standard Portlights Fixed	3, 4, 4L, 4R & 7RE	2
Standard Portlights Opening	All	2
Atlantic Portlights Fixed	All	1
Atlantic Portlights Opening	10, 30, 32	1
Atlantic Portlights Opening	40, 60	2
Stainless Steel Portlight	8	2

PLEASE NOTE:
Cut outs are a guide,
all measurements
must be checked
before cutting the hole.

LEWMAR STANDARD PORTLIGHT – CUT OUTS SHEET 1

Please check drawing is plotted 1:1 before using.
Join two parts together along Line A-A.

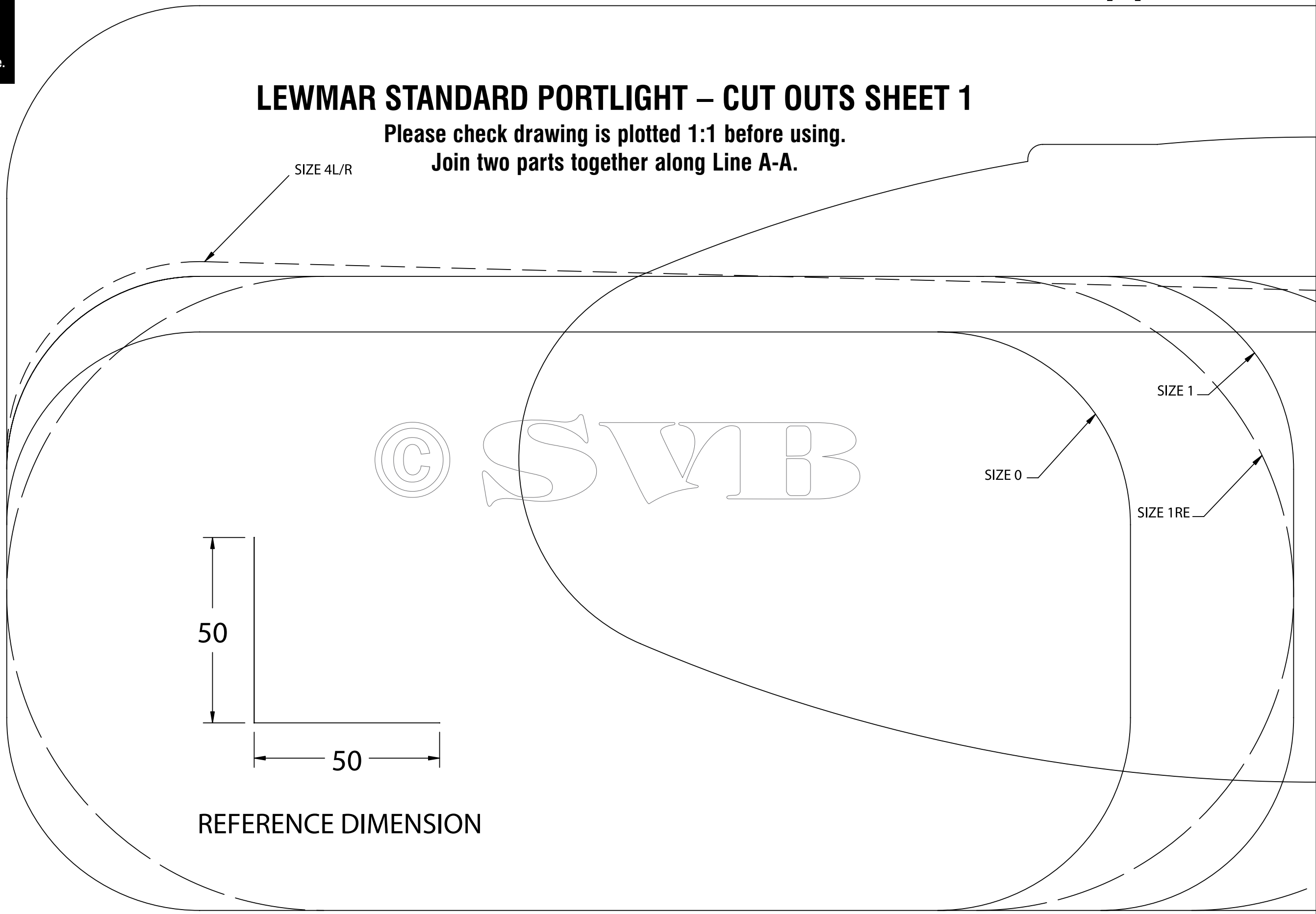

REFERENCE DIMENSION

A →

A →

PLEASE NOTE:
Cut outs are a guide,
all measurements
must be checked
before cutting the hole.

LEWMAR STANDARD PORTLIGHT – CUT OUTS SHEET 2

Please check drawing is plotted 1:1 before using.
Join two parts together along Line A-A.

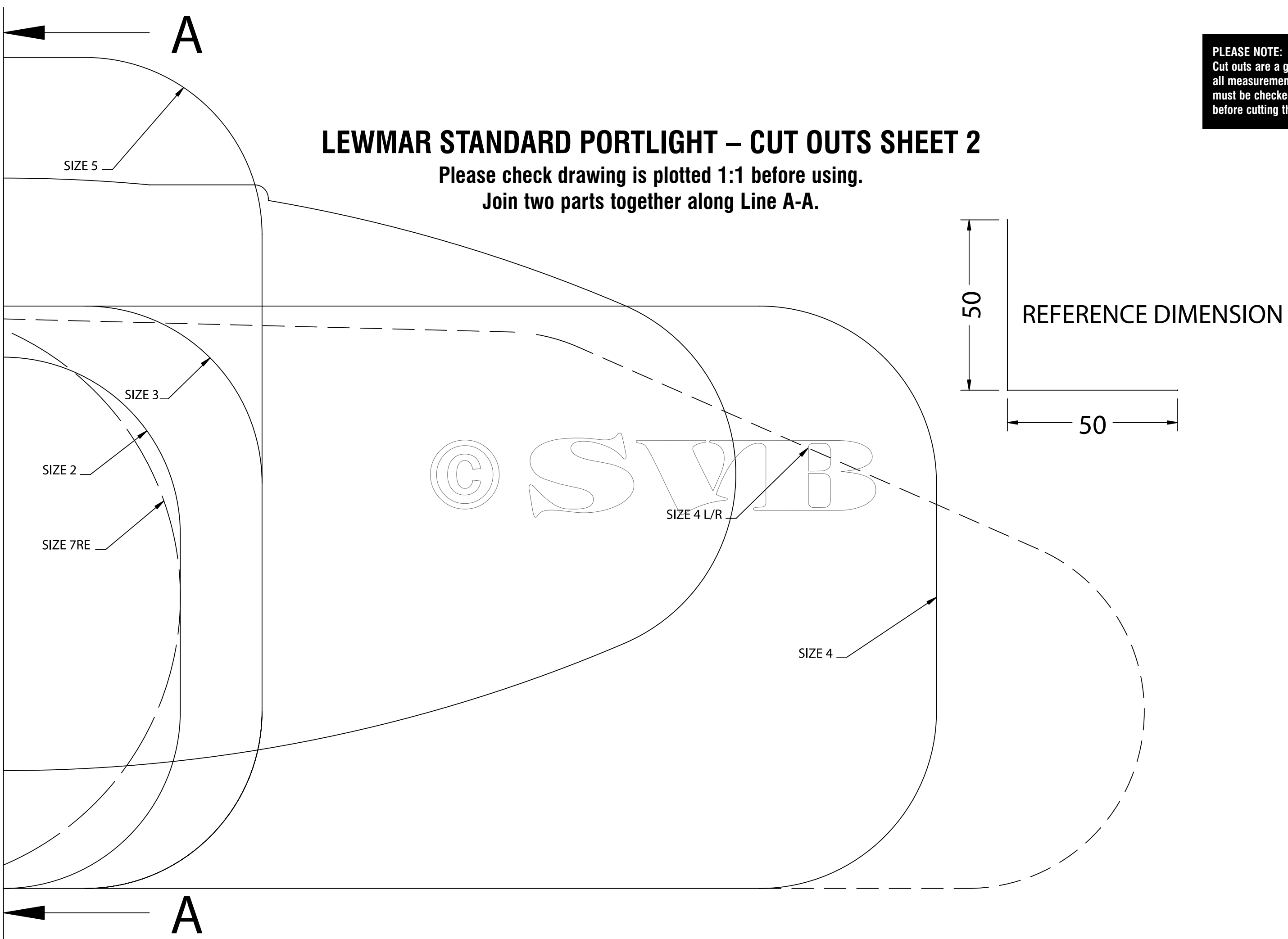

© SVMB

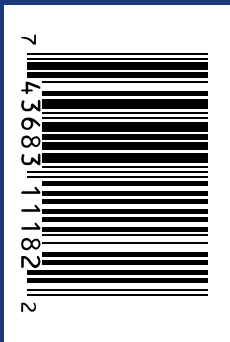

LEWMAR®

Lewmar Ltd

e-mail info@lewmar.com **website** www.lewmar.com

© Copyright 2004 Lewmar Ltd. All Rights Reserved B10439.

