

**Intellian<sup>®</sup>**

**i3/i3L/i4/i4P**

Installation and Operation Manual

SVIB

## Intellian Satellite TV Antenna Systems

---

### Intellian i3/i3L/i4/i4P Serial Number

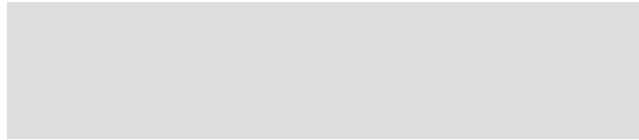

This serial number will be requested for all troubleshooting or service inquiries.



Intellian i3/i3L/i4/i4P® and Intellian® are the registered trademarks of Intellian Technologies, Inc., and should not be appropriated without permission by Intellian Technologies, Inc., and the information contained in this manual is the property of Intellian Technologies, Inc. Any and all parts of this manual shall not be reproduced and distributed in any form without written prior consent by Intellian Technologies, Inc. The information contained in this manual shall be subject to change at any time without notice due to the functional upgrade of the product.



<b>INTRODUCTION</b> .....	<b>4</b>	<b>ANTENNA CONTROL SOFTWARE</b> .....	<b>55</b>
INTRODUCTION TO INTELLIAN i3/i3L/i4/i4P .....	4	INTRODUCTION TO Aptus® .....	55
FEATURES OF INTELLIAN i3/i3L/i4/i4P .....	5	SOFTWARE INSTALLATION .....	55
BASIC SYSTEM CONFIGURATION OF INTELLIAN .....	6	PC TO ACU COMMUNICATION SETUP .....	56
<b>INSTALLATION</b> .....	<b>7</b>	ESTABLISH A DATA COMMUNICATION .....	56
SYSTEM COMPONENTS .....	7	AUTO UPDATE .....	57
TOOLS REQUIRED FOR INSTALLATION .....	10	TOOLBAR MENUS .....	58
PLANNING THE INSTALLATION .....	11	SYSTEM PROPERTY STATUS DASHBOARD .....	61
INSTALLATION AND MOUNTING OF ANTENNA .....	13	WORK VIEW TABS .....	64
<b>INSTALLING THE ACU</b> .....	<b>18</b>	<b>PREPARATION FOR TRANSPORTATION</b> .....	<b>75</b>
ACU DIMENSIONS .....	18	<b>WARRANTY</b> .....	<b>76</b>
SELECTING ACU INSTALLATION SITE .....	19	<b>APPENDIX : i3/i3L TECHNICAL SPECIFICATION</b> .....	<b>77</b>
CONNECTING THE SYSTEM CABLES OF i3/i3L/i4/i4P .....	20	<b>APPENDIX : i4/i4P TECHNICAL SPECIFICATION</b> .....	<b>78</b>
CONNECTING THE SYSTEM TO A GPS .....	23		
DC OUT PORT .....	24		
ADJUSTING THE LNB SKEW ANGLE (LINEAR POLARIZATION ONLY) .....	25		
PC TO ACU COMMUNICATION SETUP .....	26		
<b>OPERATION INSTRUCTION</b> .....	<b>28</b>		
INTRODUCTION .....	28		
<b>OPERATING THE ACU</b> .....	<b>29</b>		
ACU SOFT KEYS .....	29		
NORMAL MODE .....	29		
SETUP MODE .....	32		

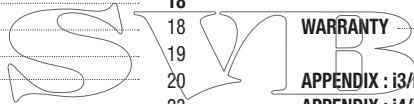

# Introduction

## Introduction to Intellian i3/i3L/i4/i4P

Intellian i3/i3L/i4/i4P is a digital satellite antenna system designed specifically for all types of vessels (anchored or transit) to automatically identify, track and capture satellite signals from the Digital Video Broadcasting (DVB: the international standard for digital TV transmissions) compatible satellites.

In details, Intellian i3/i3L/i4/i4P has Wide Range Search (WRS) algorithm, which minimizes the search time during initialization, and Dynamic Beam Tilting (DBT) technology, which dynamically shapes the antenna beam to utilize stabilization. While tracking the target satellite, DBT technology uses a high-performance, constantly adjusting sub-reflector which allows the antenna to remain relatively still, eliminating the constant whine of stepper motors while staying locked on to the satellites.

The i3/i3L/i4/i4P has a built-in GPS system which enhances the speed of satellite signals acquisitions. In addition, the i4P provides the embedded auto skew angle control system to maintain the optimal signal strength and increase the quality of satellite receptions in weak satellite single coverage area.





## Features of Intellian i3/i3L/i4/i4P

### Enjoy satellite broadcasts at sea

Intellian i3/i3L/i4/i4P is the most modern antenna system that enables you to receive a high quality broadcasting signal at sea, where the atmospheric and environmental condition are very harsh. This fully automatic control system allows you to simply turn the power switch on, and have crystal clear, high quality satellite television in motion or at anchor.

### High quality antenna

High tech parabolic antenna technology has been adopted for this antenna system, which is optimal for marine conditions. This enables you to receive the optimal signal level even when it is raining or snowing.

### Fast and efficient search for the satellite

The WRS (Wide Range Search) algorithm allows for the antenna system to search the satellite within the shortest amount of time and to detect the satellite signal under any position and with any directional movement of the vessel.

### Easy installation and outstanding reliability

Intellian i3/i3L/i4/i4P uses only one RF cable for installation. This makes installation easy. Power, RF and data signals transfer from the antenna to the ACU through this single cable. In addition, Intellian i3/i3L/i4/i4P provides highly reliable system through the implementation of a modularized design, and the usage of strictly proven components.

### Built-in GPS

The built-in GPS system enhances the speed of acquisition of the satellite signal and provides Intellian i3/i3L/i4/i4P even higher performance.

### Ethernet Port for management

The Ethernet Port on the rear panel of the ACU enables direct and simple network connection between a PC and the ACU. By connecting to ISP or the modem linked with VSAT systems, Intellian i3/i3L/i4/i4P can be monitored, controlled, and diagnosed remotely from anywhere, anytime through the TCP/IP protocol.

This not only can save tremendous time but also save the cost generated from the hundreds of routine maintenance activities such as operating firmware upgrades, tracking parameters resets, and system diagnostic.

### Wireless Connectivity and Aptus mobile

The built-in WiFi enables the ACU to be wirelessly connected. Any kind of wireless devices such as PCs, laptops and smartphones can be used to connect to the ACU and monitor, control and change the settings of the system wirelessly. Intellian Aptus mobile is available for download to access to the ACU via Wi-Fi and operate the antenna from iPhone, iPad or other network devices.

iPhone and iPad are registered trademarks of Apple Inc.

### Built-in automatic skew angle control system (i4P Only)

The automatic skew control system allows Intellian i4P to maintain the optimal skew angle at all times and ensure maximum level of satellite signal level receptions.

### Intellian's environmental test standards certified

These standards are much severer than a typical experienced marine equipment condition. All testes performed with one unit through all continued sequences. Intellian standards meet LR and DNV standards as well as EN60945.

## Basic System Configuration of Intellian

For your satellite TV system to function properly, the system will have to be connected with all of the provided components as shown on the right (Refer to the next chapter 'Installation' in this manual for more detailed connection instructions). Separate purchase of a satellite receiver and a TV is required.

**Note:** i3L can only be connected to one receiver.

**Note 2:** Dish and Bell TV users please refer to the Intellian Dish MIM Installation and User Manual.

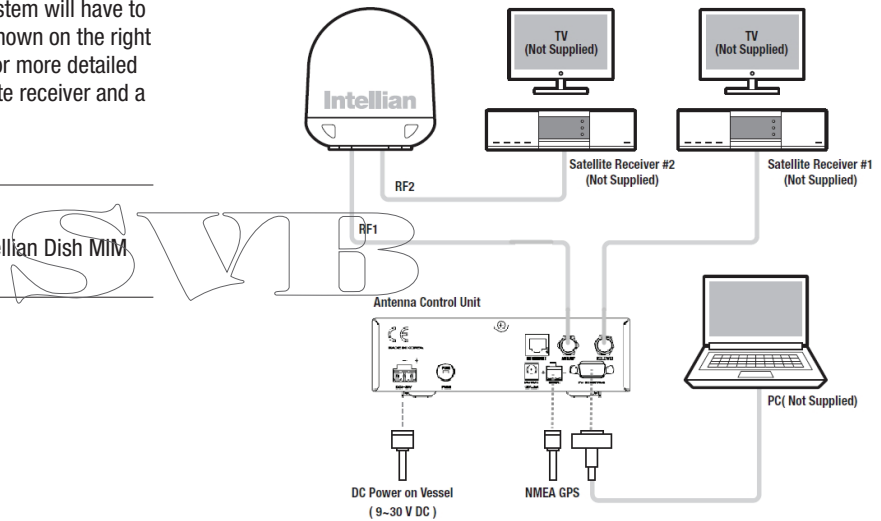

Figure 01 : Basic Configuration with 2 Receivers

---

## Installation

The components of the Intellian i3/i3L/i4/i4P are designed as module system so that it is suitable for simple installation on all types of vessels.

### System Components

#### Antenna Unit

The antenna of Intellian i3/i3L/i4/i4P is comprised of the following components for optimum search and receiving satellite signal.

- Mechanical Unit – manipulates the antenna to receive the optimal satellite signal regardless of the movement of the vessel.
- Control Unit – controls mechanical operation of the antenna.
- RF Unit – transmits the optimum satellite signal to the receiver.
- Radome – protects the antenna from the severe marine environment.

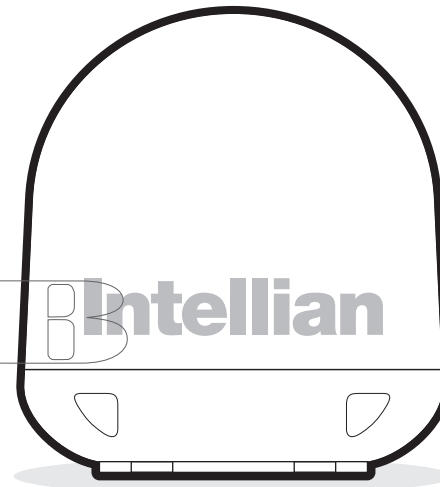

Figure 02 : Radome

## Intellian Satellite TV Antenna Systems

### Antenna Control Unit (ACU)

The Antenna Control Unit (ACU) provides the power to the antenna and controls the various settings of the antenna. The digital VFD (Vacuum Fluorescent Display) allows for easy operation of the ACU, even in the dark.

The functions of the ACU are as follows:

- Controls the antenna system
- Provides power to the antenna unit
- Monitors the antenna status
- Changes the target satellite
- Set up the user environment
- Set the current GPS information
- Set satellite information
- Move antenna manually
- Perform self-diagnosis of the antenna
- Set up the interface with a PC

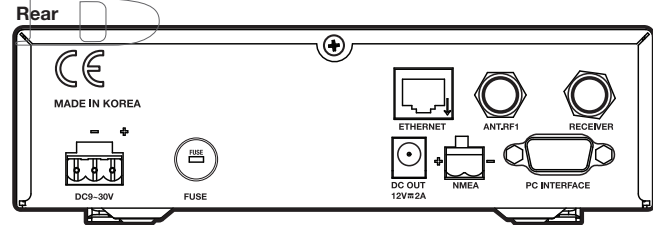
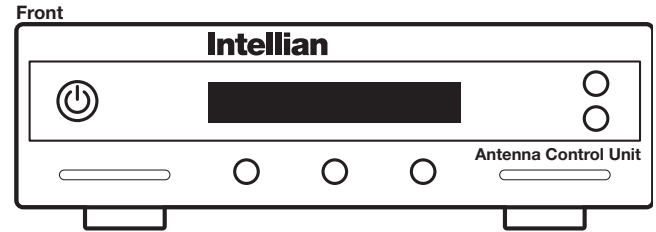

Figure 03 : Front & Rear of ACU

## Installation Kit

Contains the items required for securing the antenna unit and ACU to the vessel.







Antenna					
Item					
	Hex.Bolt	Hex.Head Wrench Bolt	Flat Washer	Spring Washer	Hex. Nut
Qty	5	5	5	5	5
ACU					
Item					
	Self-Tapping Screw		Machine Screw		
Qty	5		5		
Size	(M4 X 16L)		(M3 X 8L)		

Figure 04 : Installation Bolt Kit

## Other Components

No	Components	Size	Qty
1	ACU Table Mounting Bracket	-	2EA
2	RF Cable (ACU to IRD)	49ft (15m)	1EA
3	RF Cable (ACU to IRD)	10ft (3m)	1EA
4	DC Power Cable	33ft (10m)	1EA
5	PC Serial Cable	6ft (1.8m)	1EA
6	NMEA Connector	AK950-2	1EA
7	Power Connector	AK950-3	1EA
8	Hex Bolt	M8x35L	5EA
9	Tapping Screw	ø4x16L ø3x8L	5EA 5EA
10	Flat Washer	M8	5EA
11	Spring Washer	M8	5EA
12	Aptus CD	-	1EA
13	User Manual	-	1EA
14	Mounting Template	i3/i3L i4/ i4P	1EA
15	Quick Installation Guide	-	1EA

Figure 05 : List of the Supplied Parts

## Tools Required for Installation

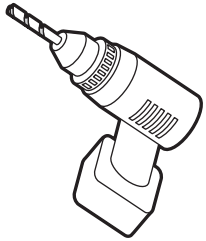

Power Drill

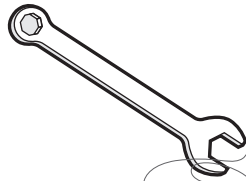

11 mm Spanner

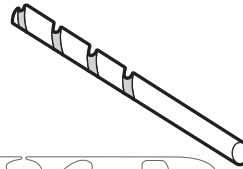

10 mm Drill Bit

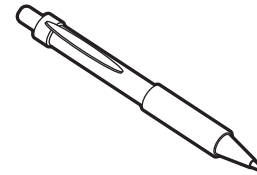

Pencil

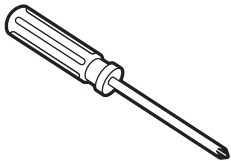

Cross-Head  
Screwdriver

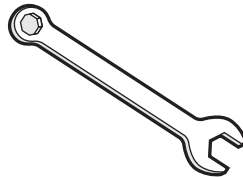

13 mm Spanner



Ø80 mm  
Hole Saw

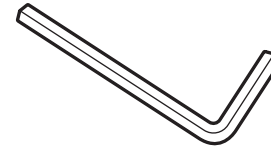

5 mm  
Allen/Hex key

Figure 06 : Required Tools for Installation

---

## Planning the Installation

### Antenna Unit

Install the antenna in accordance with the following procedures to ensure maximum performance of the antenna. The antenna should be installed in a place where it has an all-around clear view of the horizon. Please be sure there are no obstacles within 15 degrees above the antenna. Any obstacles can prevent the antenna from tracking the satellite signal (Refer to the drawing on the right).

Do not install the antenna near by the radar especially on the same plane as their energy levels may overload the antenna front-end circuits. It is recommended to position the antenna at least 4 feet (1.2m) above or below the level of the radar and minimum of 15 feet (6m) away from the high power short wave radars.

The mounting platform should be rigid enough and not subjected to excessive vibration. The movement of the antenna can be minimized by installing at the center of the vessel. For optimal performance of the antenna, it is not recommended to install at any corner of the vessel, where the movement of the vessel is the greatest. Install the bottom of the antenna parallel to the surface of the sea and fix tightly to the structure of the vessel. When setting the antenna down, be careful not to damage the RF connector. Striking the connectors on the bottom directly will damage the connector.

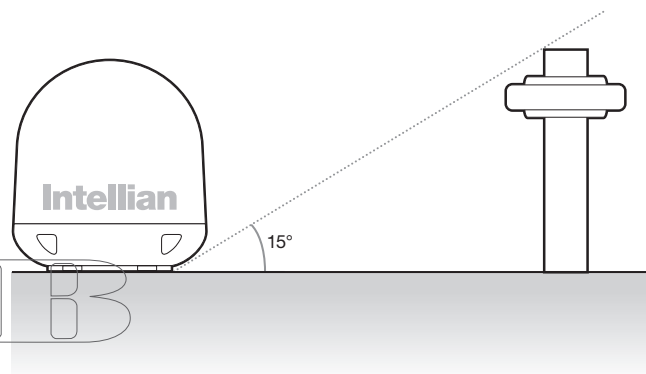

**Figure 07 : Elevation Limit of Obstacles**

## Intellian Satellite TV Antenna Systems

---

### Cables

Before installing the system cables, consider the following points.

- All cables need to be well clamped and protected from physical damage and exposure to heat and humidity.
- Cables with severe bends are not allowed.
- Where a cable passes through an exposed bulkhead or deckhead, a watertight grommet or swan neck tube should be used.

### Power Requirements

Follow the power requirements to avoid damage to the system.

The Intellian i3/i3L/i4/i4P has been designed to work on a boat's power supply rated from 9 ~ 30 V DC.



If your IRD(s) and television(s) require a 110V/240V AC power supply, you will need to install a suitable DC to AC converter to operate the unit(s) from your boat's DC power supply.

### RF Cable

This cable is supplied at a length of 49ft (15m). If a longer length is required you should replace this cable with an extended RF cable supplied by Intellian Technologies.

### Extending the Cables

The cables that have been supplied with your Intellian system should be of adequate length to complete the installation on most vessels.

---

**Note:** Exceeding the indicated cable lengths will result in reduced performance of your system.

---



---

## Installation and Mounting of Antenna

The method of installation and mounting of antenna may vary due to vessel design but the following procedures are applicable in most situations, and will result in a secure and effective installation.

### Confirmation of Size Prior to Installation

- Check the height and diameter of the bottom surface of the antenna before installing.
- The space must be sufficient for installing the antenna unit considering the height and diameter of the antenna.
- The height and the diameter of the bottom surface of the antenna are as shown in the following drawing.  
If possible, install the antenna using a power tower.

---

**Note:** Before installing the antenna, open the radome and remove the shipping constraints from the antenna interior. Reinstall the radome before operating the system. The system will not perform properly if the radome is open.

---

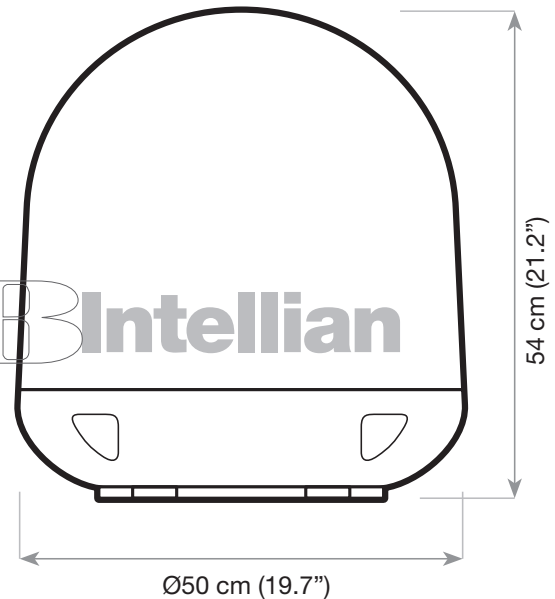

Figure 08 : Radome Dimension of i4 / i4P

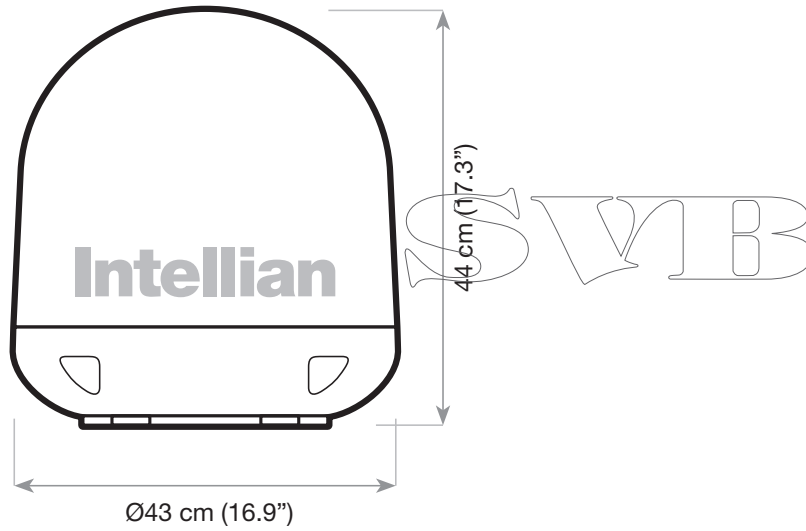

Figure 09 : Radome Dimension of i3 / i3L

---

### Mark of the Antenna Mounting Position

Referring to the mounting template, mark where antenna will be mounted on board (it must be a flat surface) or on a separate power tower.

---

**Note:** If a power tower is not suitable to mount the antenna, separate cable shock and waterproofing measures must be taken to protect the RF connector from being exposed to the sea water and external shocks. An exposed cable may cause electric shock and cause serious damage to the equipment.

---

The logo consists of the letters 'S', 'V', 'M', and 'B' in a stylized, outlined font. The 'S' is on the left, followed by 'V', 'M', and 'B' on the right. The letters are interconnected and have a decorative, slightly irregular appearance.

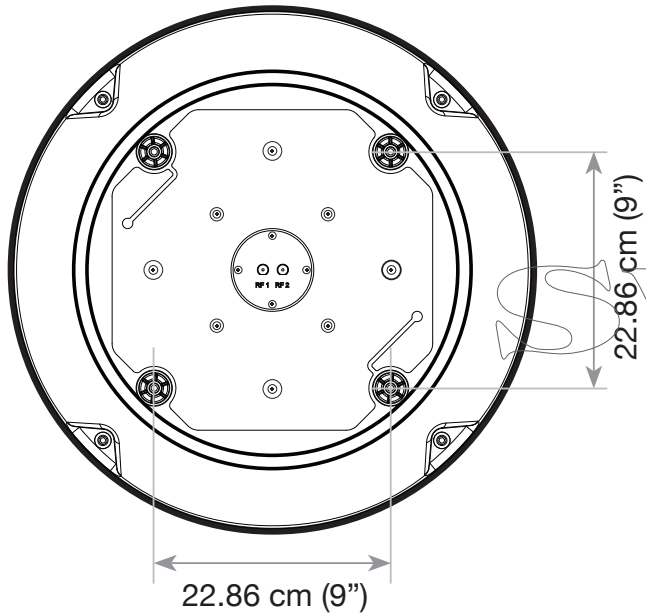

Figure 10 : Mounting Hole Position of i4 / i4P

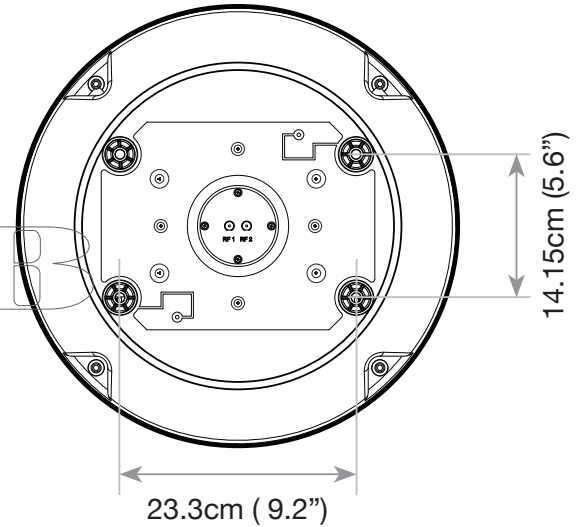

Figure 11 : Mounting Hole Position of i3 / i3L

### Securing Holes for Bolts and Cable Ways

Make 4 bolt holes of 10mm diameter, one at each corner of a rectangle drawn as below, and make a circular hole of 80mm diameter at the center of the rectangle through which the cable will run.

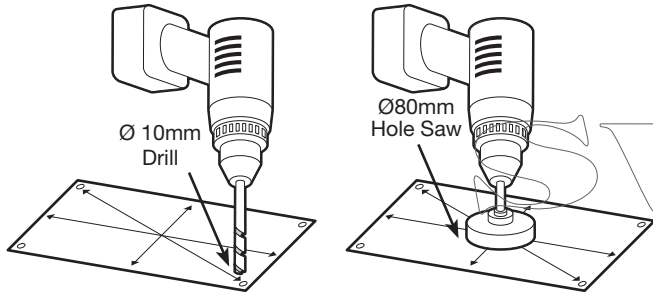

Figure 12 : Drilling Instruction

### Connection of the Cable

Remove the rubber cap from RF connector. Connect the RF cable to the RF connector under the base plate through the access hole using an 11mm spanner. Be careful not to over tighten, as you may damage the connector.

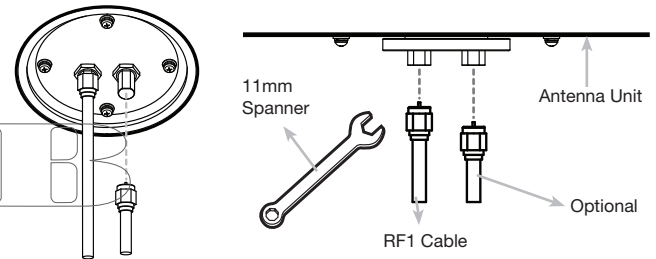

Figure 13 : Connectors on Bottom of Antenna

**Note:** Do not tighten excessively when using the spanner, this will damage the threads. Be careful that the connectors do not touch the mounting surface of the antenna, this might cause a critical malfunction and serious damage to the equipment.

## Mounting the Antenna

Attach the antenna by using the hex head bolts (M8X35L), M8 spring washers, and M8 flat washers supplied.

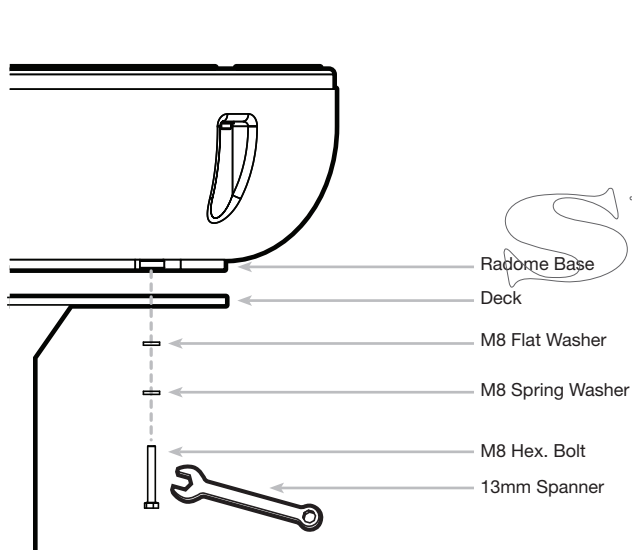

Figure 14 : Mounting the Antenna

## Installing the ACU

### ACU Dimensions

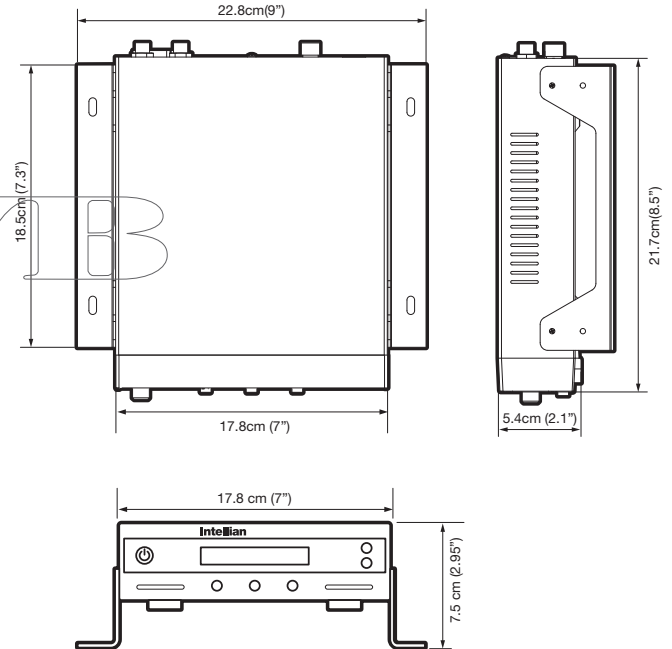

Figure 15 : Dimension of ACU

---

## Selecting ACU Installation Site

The ACU should be installed below deck, in a location that is:

- Dry, cool, and ventilated.
- Easy access from your main TV viewing area.

### To Install the ACU

1. The ACU should be installed using the two supplied mounting brackets which allow for a top or bottom mounting configuration.
2. Using the self tapping screws supplied, attach the mounting brackets to the sides of the ACU.
3. Place the ACU in the location where it is going to be installed.
4. Connect the cables to the rear of the ACU.
5. Use a pencil to mark the 4 hole positions (two on each side), and use the appropriate drill bit to drill.

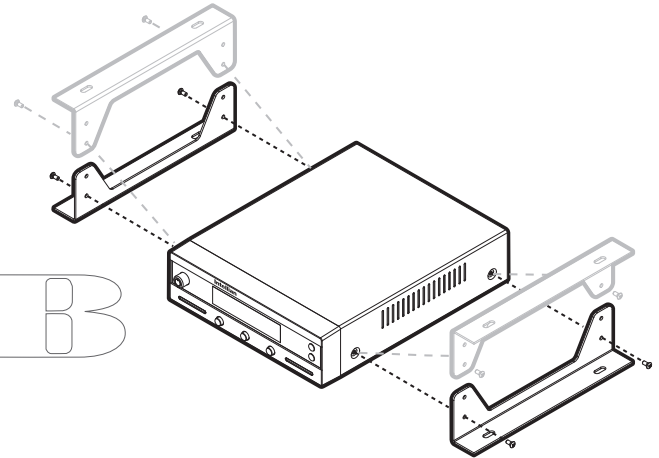

Figure 16 : Installation of ACU

### Connecting the System Cables of i3/i3L/i4/i4P

After installing and mounting the antenna, connect the ACU to the antenna. Refer the drawing on the right to connect the cables.

#### Single IRD Connection

1. Connect the RF cable 49ft (15m) from the RF 1 connector on the antenna base plate to the ANT. RF1 connector on the ACU.
2. Connect the RF cable 10ft (3m) from the RECEIVER connector on the ACU to RF connector on the IRD.
3. Connect the DC power cable 33ft (10m) from DC power connector on the ACU to a power source from 9~30 V DC.
4. Press the POWER ON switch on the ACU to start the operation of the antenna system.

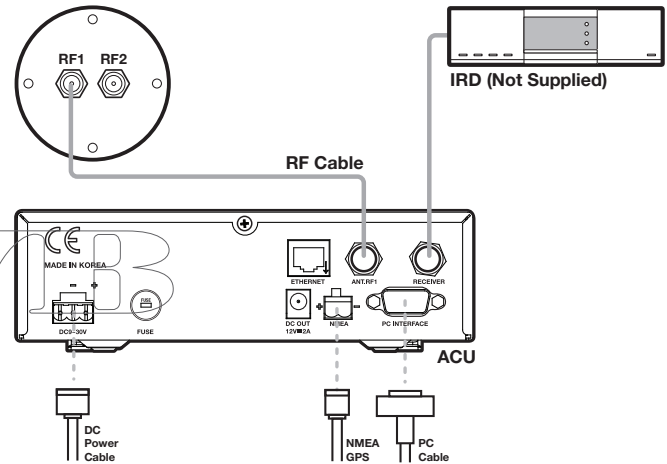

Figure 17 : Single IRD Configuration



## Dual-IRDs Connection

You can connect two IRDs from your antenna as shown in the above diagram. The IRD connected to ACU determines which satellite is tracked, while the other receiver can watch any channel which is available from the tracked satellite.

As in the single IRD option the RF cables from the antenna base plate should be connected to 'LNB', 'ANT', or 'Satellite In' connector on the IRD.

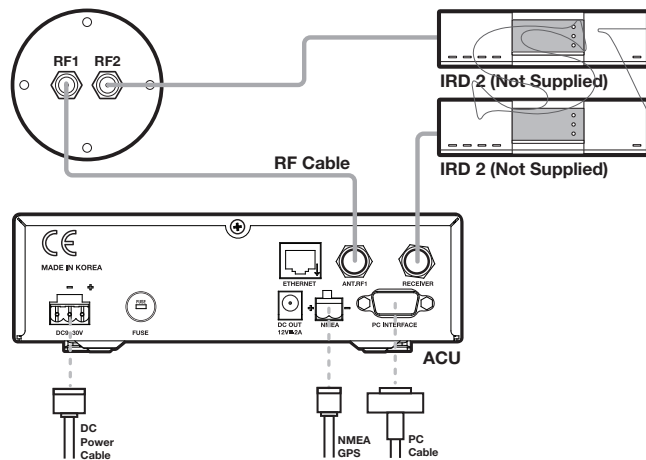
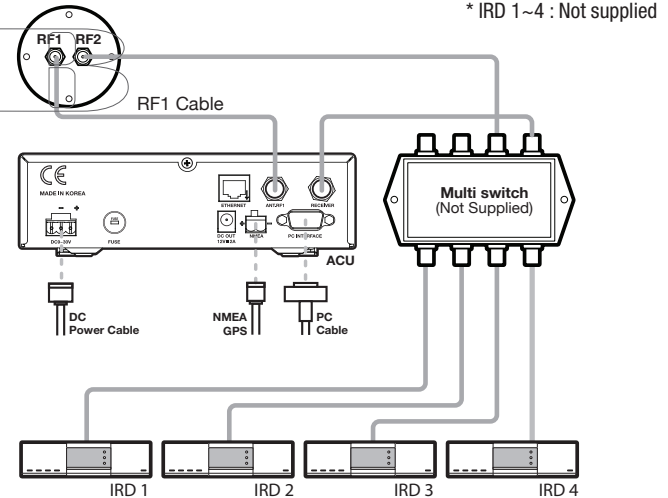

Figure 18 : Dual-IRDs Configuration

## Multi-IRDs Connection

In order to connect multi-IRD to the antenna, you will need to purchase a suitable multiswitch. The multiswitch has to be installed between the antenna unit and the IRDs as shown in the following diagram.



\* IRD 1~4 : Not supplied

Figure 19 : Multi-IRDs Configuration

## Intellian Satellite TV Antenna Systems

### Connecting the System Cables of i3L

After installing and mounting the antenna, connect the ACU to the antenna. Refer the drawing on the right to connect the cables.

#### Single IRD Connection

1. Connect the RF cable 49ft (15m) from the RF 1 connector on the antenna base plate to the ANT. RF1 connector on the ACU.
2. Connect the RF cable 10ft (3m) from the RECEIVER connector on the ACU to RF connector on the IRD.
3. Connect the DC power cable 33ft (10m) from DC power connector on the ACU to a power source from 9~30 V DC.
4. Press the POWER ON switch on the ACU to start the operation of the antenna system.

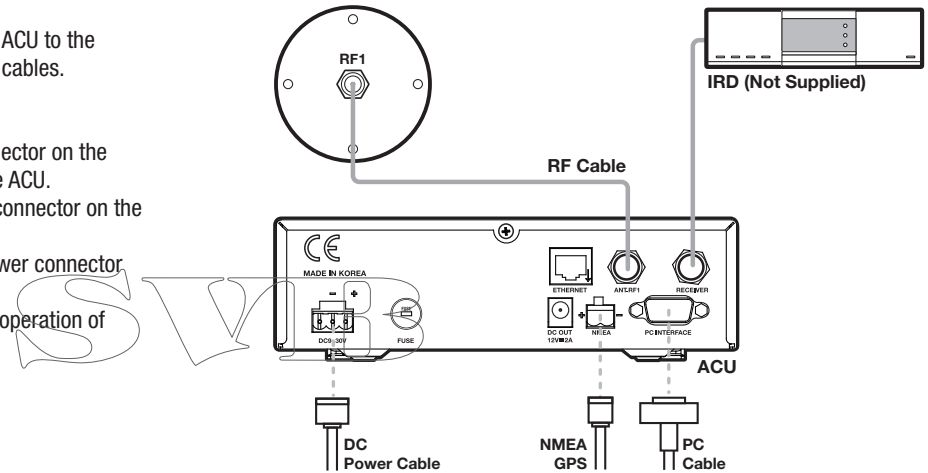

Figure 20 : Single IRD Configuration

## Connecting the System to a GPS

Your satellite TV system has a built-in GPS. If the internal GPS doesn't operate properly, you can directly connect your boat's NMEA 0183 GPS to the system through the ACU's external GPS connector. To do this you will need a suitable cable to connect your GPS system and the green 2-way ACU GPS connector supplied with your Intellian i3/i3L/i4/i4P Satellite TV System.

### To Connect the System to a GPS

1. Strip back the insulation of each cable and connect a cable to each terminal of the 2-way connector.
2. Tighten the locking screws.
3. Connect the cable from the + (positive) terminal of the ACU GPS connector to the NMEA OUT wire of the vessel's GPS system.
4. Connect the cable from the – (negative) terminal of the ACU GPS connector to the Ground Wire of the vessel's GPS system.
5. Refit the ACU GPS connector to the rear of the ACU.

SVIB

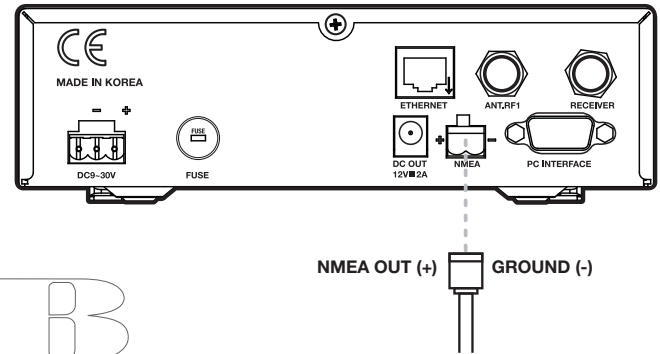

Figure 21 : NMEA 0183 Connection

## Intellian Satellite TV Antenna Systems

---

### DC OUT port

Intellian ACU provides DC OUT port for direct connection of MIM(Multi-satellite Interface Multi-switch) or SDM (Shaw Decoder Module) which requires DC power input. Intellian MIM or SDM can be connected to the i-series ACU without AC-DC Adaptor.

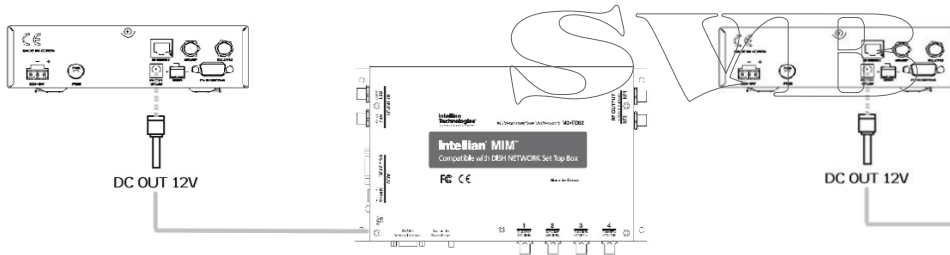

Figure 22 : DC out MIM



Figure 23 : DC out SDM

---

**Note:** The DC power cable is included in the component list of MIM and SDM.

---

**Note:** The i3/i3L antenna system is not compatible with SDM.

---

## Adjusting the LNB Skew Angle (Linear Polarization Only)

### LNB Skew Angle

The LNB skew angle only needs to be adjusted when the target satellite is linear polarized. In order to receive the maximum satellite signal level, the LNB skew angle must be adjusted according to the calculation of current GPS location and target satellite.

It only needs to be adjusted when changing from one satellite to another, or when the vessel has traveled a significant geographic distance. It should NOT need to be readjusted if the vessel stays in the same location and is operating on the same satellite.

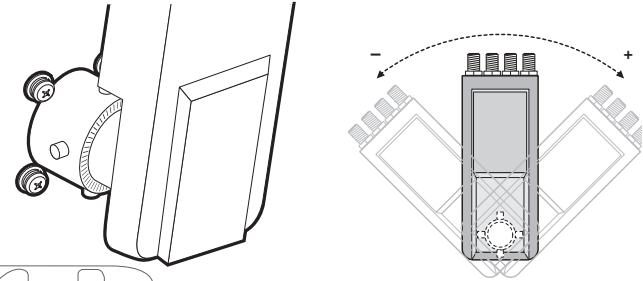

**Figure 24 : Manual LNB Skew Angle Adjustment**

### Skew Angle Adjustment of i3/i3L/i4

Polarization of your Intellian i3/i3L/i4 antenna must be accomplished manually by the following steps.

1. Open the radome after switching power OFF.
2. Loosen 4 bolts of the connection of LNB and feed horn.
3. Turn LNB to place it to the angle indication of the back of the feed horn.
4. Tighten the 4 bolts.
5. Re-install the radome .

### Auto LNB Skew Angle Adjustment for i4P

Intellian i4P has an embedded auto skew angle control system. Therefore, manual adjustment of LNB skew angle is not required. The LNB skew angle is continuously adjusted automatically through the calculation of current GPS location and target satellite. The skew angle of LNB is shown from the ACU and GUI Program.

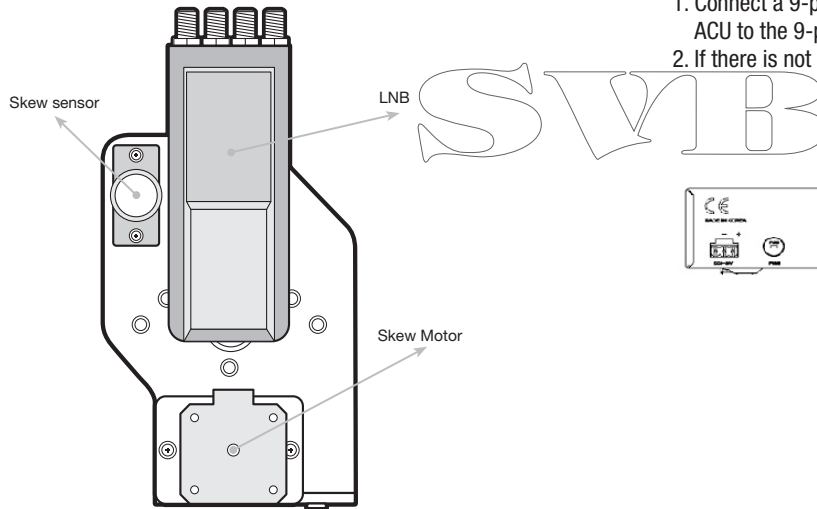

Figure 25 : Auto LNB Skew Angle Adjustment System

### PC to ACU Communication Setup

You can establish data communication between a PC and the ACU using one of the following methods.

#### Serial Connection

##### Connection through Serial Port

1. Connect a 9-pin Serial cable from the PC INTERFACE connector on the ACU to the 9-pin serial port on your PC.
2. If there is not a 9-pin serial port on the PC, use a USB-Serial adapter.

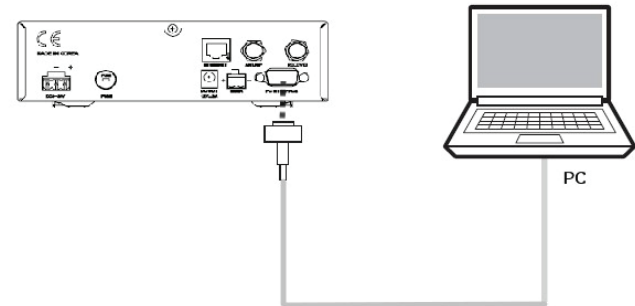

Figure 26 : Serial Connection

## Wi-Fi Connection

### Setup Wi-Fi Connection

- Setting up the PC in order to access Wi-Fi
  1. Connect Wi-Fi.  
After clicking on the Windows Wireless Connection icon, click on i-AP(default).
  2. By default, the connection security is opened.
  3. Use the ACU's IP address to access Intellian Aptus®
    - Default: 192.168.1.223



Figure 27 : ACU to PC Wifi Connection

## TCP/IP Connection

### Connection through Rear Panel Ethernet Port

This method requires separate IP configuration on a PC.

1. Connect an Ethernet cable from a PC Ethernet port to Ethernet port on the back of the ACU
2. Go to Control Panel > Network and Sharing Center > Change Adapter Settings and right-click on the Local Area Connection then click Properties
3. Select TCP/IPv4, then click Properties.
4. Change the network settings on a PC;
  - IP Address: 192.168. 0.222
  - Subnet Mask: 255.255.255.0
  - Gateway: 192.168.0.223
5. Use the ACU's IP address to access Intellian Aptus® .
  - Default: 192.168.0.223

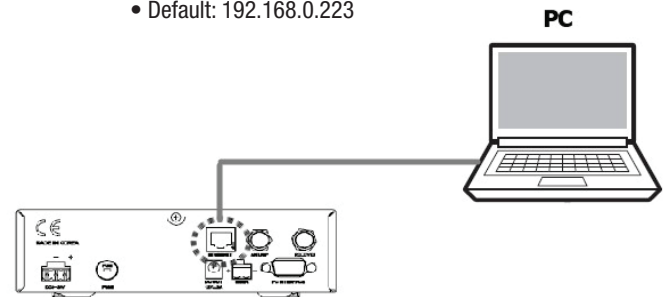

Figure 28 : ACU to PC TCP/IP Connection

# Operation Instruction

## Introduction

This section of the handbook describes how to setup your Satellite TV System after installing the ACU. It includes the following functions:

- Start up.
- Changing target satellite.
- Monitoring the current status of the antenna.
- Sleep mode.

## Setup Mode

- Begin setup mode.
- Setting the satellite pair.
- Setting GPS.
- Edit satellite information.
- Setting the antenna parameters.
- Setting the LNB local frequency.
- Setting the DiSEqC method.
- Display versions.
- Display power.
- Setting remote control.
- Setting antenna go position.
- Setting antenna move step.
- Executing antenna diagnosis.
- Setting region.
- Setting the factory default parameters.

---

**Note:** Many of the above functions will only be required only after initial installation of your system. Refer to the Quick Installation Guide before operating the system.

---





# Operating the ACU

## ACU Soft Keys

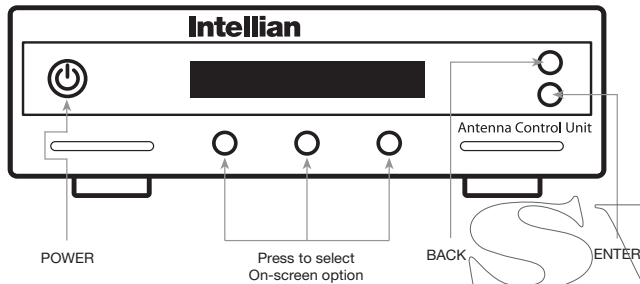
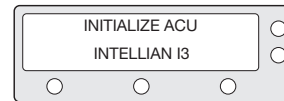

Figure 25 : ACU Soft Keys

## Normal Mode

### Start Up

With the system installed and power applied, the ACU screen will show the following sequence:



1. Data communication is being established between the antenna and the ACU. The ACU is initialized.

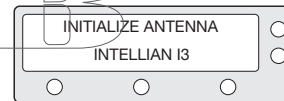

2. The antenna is initialized.

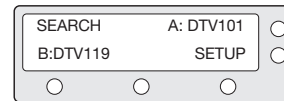

3. The antenna is searching for Satellite A.

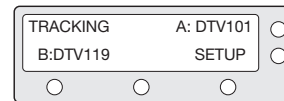

4. The antenna has located the satellite and is now tracking.

**Note:** The operation method is exactly same for i3, i3L, i4, and i4P. The following instruction will be described using the i3 as example.

# Intellian Satellite TV Antenna Systems

## Changing Target Satellite

Your antenna is programmed with either two (Dual-Sat mode) or three (Tri-Sat mode) candidates of target satellites as default mode. To change the target satellite, press LEFT soft key. The target satellite is changed and is automatically tracked by the antenna.

## Dual-Sat Mode

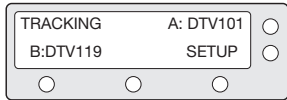

1. Press LEFT soft key for tracking Satellite B.

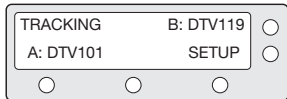

2. The antenna is tracking Satellite B.

## Tri-Sat Mode

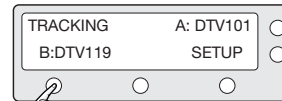

1. Press LEFT soft key for tracking Satellite B.

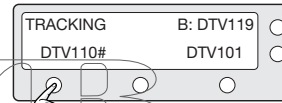

2. The antenna is tracking Satellite B.

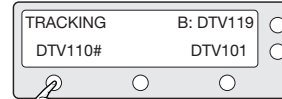

3. Press LEFT soft key for tracking Satellite C.

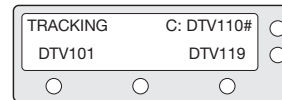

4. The antenna is tracking Satellite C.

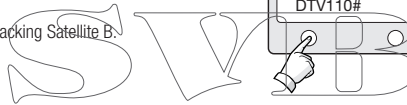

## Monitoring the Current Status of the Antenna

When the ACU power is on, it displays the status of the antenna.

The current status of the antenna is displayed as shown below.

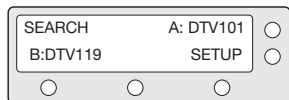

1. The antenna is searching Satellite A.

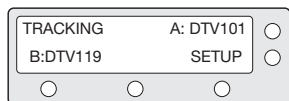

2. The antenna is tracking Satellite A.

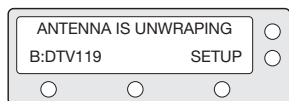

3. The antenna is winding/unwinding the cables in the antenna.

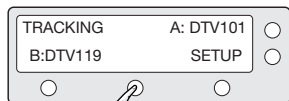

4. The antenna is again tracking Satellite A. Press center soft key to display position detail.

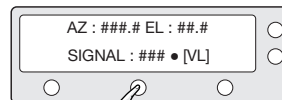

5. Antenna position detail and signal strength are displayed.



6. Press center soft key to display current GPS information. Press center soft key to return to main tracking mode.



## Sleep Mode

If the antenna loses the tracking satellite while in sleep mode, sleep mode will be cancelled.

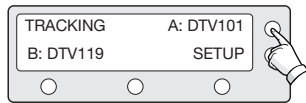

1. Press BACK to enter sleep mode.

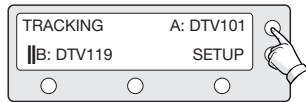

2. Press BACK again for exiting sleep mode.

## Setup Mode

### Begin Setup Mode

To enter the Setup Mode simply follow the instructions below.

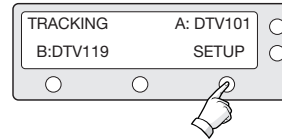

1. While the antenna is tracking press SETUP

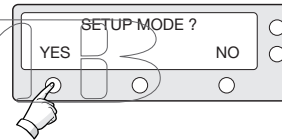

2. Press YES to enter setup mode.

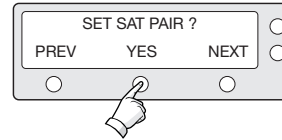

3. Press YES to set the satellite pair.

## Setting the Satellite Pair

You can change the satellite pair if you decide to receive satellite television service from a different service provider.

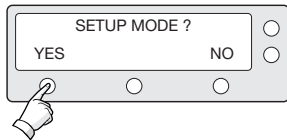

1. Press YES to enter setup mode.

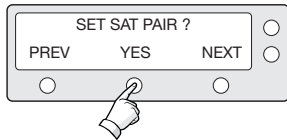

2. Press YES to set satellite pair.

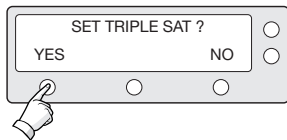

3. Press YES to set triple satellites.

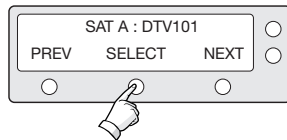

4. Set satellite A  
Press PREV to show previous satellite name.  
Press SELECT to set chosen satellite to SAT A.  
Press NEXT to show next satellite name.

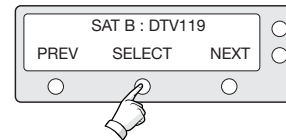

5. Set satellite B  
Press PREV to show previous satellite name.  
Press SELECT to set chosen satellite to SAT B.  
Press NEXT to show next satellite name.

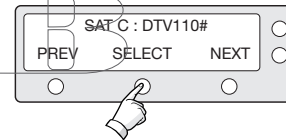

6. Set satellite C  
Press PREV to show previous satellite name.  
Press SELECT to set chosen satellite to SAT C.  
Press NEXT to show next satellite name.

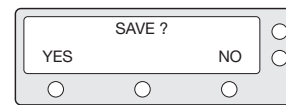

7. Press YES to save selections.  
Press NO to cancel and return to main setup mode.

## Setting GPS

It is possible to set up and modify the GPS information, which enhances the antenna functionality.

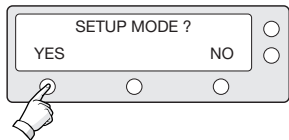

1. Press YES to enter setup mode.

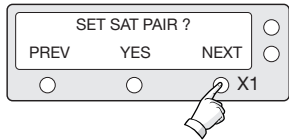

2. Press NEXT to enter GPS setup mode.

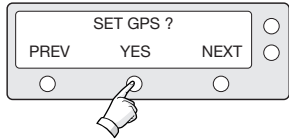

3. Press YES to set GPS.

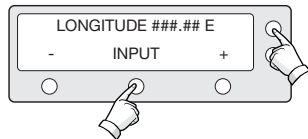

4. Input the longitude data.  
+ increases the value. - decreases the value.  
Change the underscored digit using the +/- buttons.  
Press INPUT to accept the value and move to next digit. Press BACK to move to previous digit.

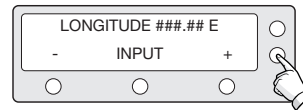

5. Press ENTER to move to next screen.  
Press BACK to move to previous screen.

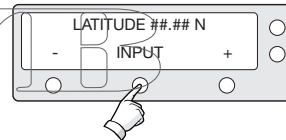

6. Input the latitude data.  
+ increases the value. - decreases the value.  
Change the underscored digit using the +/- buttons.  
Press INPUT to accept the value and move to next digit.  
Press BACK to move to previous digit.



7. Press YES to accept data.  
Press NO to cancel and return to main setup mode.

## Edit Satellite Information

It is possible to modify the existing satellite information and input new satellite information into the ACU as well. It is not recommended for a novice satellite service user to use this mode.



1. Press YES to enter setup mode.

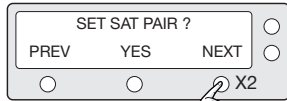

2. Press NEXT twice to enter edit satellite info mode.

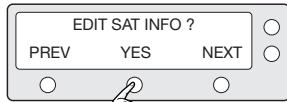

3. Press YES to edit satellite info.

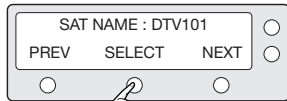

4. Set the satellite name.  
PREV - Shows previous satellite name.  
SELECT - Select the displayed satellite for editing.  
NEXT - Shows next satellite name.  
Press ENTER to move to next screen.

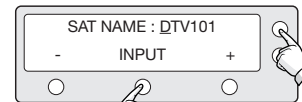

5. Input the satellite name.  
+ increases the value. - decreases the value.  
Change the underscored digit using the +/- buttons.  
Press INPUT to accept the value and move to next digit.  
Press BACK to move to previous digit.

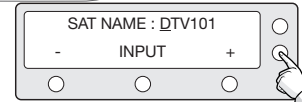

6. Press ENTER to move to next screen.  
Press BACK to return to previous screen.

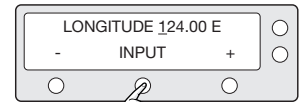

7. Input the satellite position.  
+ increases the value. - decreases the value.  
Change the underscored digit using the +/- buttons.  
Press INPUT to accept the value and move to next digit.  
Press BACK to move to previous digit.

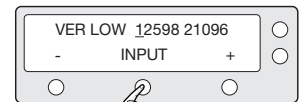

8. Input the tracking frequency (MHz) and symbol rate (KHz) for vertical low band.

# Intellian Satellite TV Antenna Systems

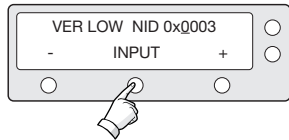

9. Input the network ID (NID) for vertical low band.

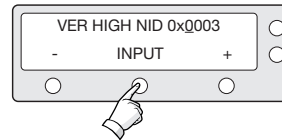

13. Input the network ID (NID) for vertical high band.

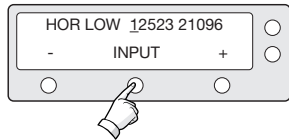

10. Input the tracking frequency (MHz) and symbol rate (KHz) for horizontal low band.

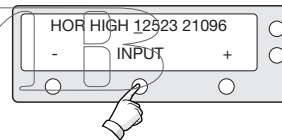

14. Input the tracking frequency (MHz) and symbol rate (KHz) for horizontal high band.

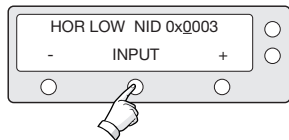

11. Input the network ID (NID) for horizontal low band.

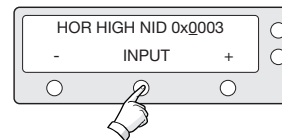

15. Input the network ID (NID) for horizontal high band.

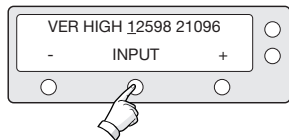

12. Input the tracking frequency (MHz) and symbol rate (KHz) for vertical high band.

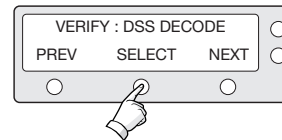

16. Select the **Verification Method\*** of tracking satellite.  
PREV - Shows previous method.  
SELECT - Set the displayed method.  
NEXT - Shows next method.



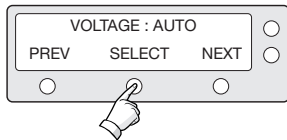

17. Select the **Voltage Supply Method\*** to LNB.  
(AUTO is recommended)

**Verification Method\***

- SIGNAL - use only signal level for tracking
- DVB LOCK - use only DVB Lock signal for tracking
- DVB DECODE - verify satellite using DVB decoding method for tracking
- DSS DECODE - decode only DSS Lock signal for tracking

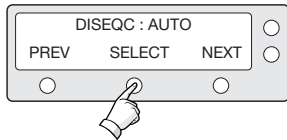

18. Select the **DISEQC Method\***.  
(AUTO is recommended)

**Voltage Supply Method\***

- AUTO – Supply 13V or 18V to LNB
- ONLY 13 V - always supply 13 V to LNB
- ONLY 18 V - always supply 18 V to LNB



19. Press YES to save the input information.  
Press NO to cancel and return to main setup mode.

**DISEQC Method\***

- AUTO – Supply 0KHz tone or 22KHz tone to LNB
- ONLY 0 KHz – always supply 0KHz tone to LNB
- ONLY 22 KHz – always supply 22KHz tone to LNB

# Intellian Satellite TV Antenna Systems

## Setting the Antenna Parameters

It is not recommended for a novice satellite service user to use this mode. Consult Intellian for changing antenna parameters.

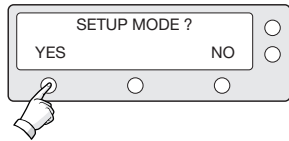

1. Press YES to enter setup mode.

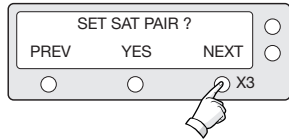

2. Press NEXT three times to enter set antenna parameter mode.

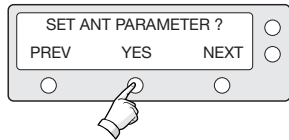

3. Press YES to set antenna parameter.

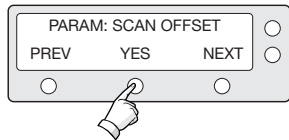

4. Select the **PARAM\***.  
PREV - Shows previous parameter.  
SELECT - Set the displayed parameter.  
NEXT - Shows next parameter.  
Press ENTER to move to next screen.

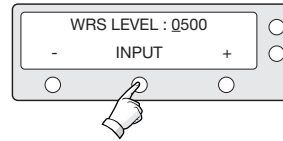

5. Input the WRS LEVEL.  
+ increases the value. - decreases the value.  
Change the underscored digit using the +/- buttons.  
Press INPUT to accept the value and move to next digit.  
Press BACK to move to previous digit.  
Press ENTER to move to next screen.

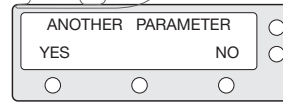

6. Press YES to set up another parameter.  
Press NO to cancel and return to main setup mode.



7. Press YES to save the input information.  
Press NO to cancel and return to main setup mode.

SVTB

---

**PARAM\***

**Scan Offset** The scan offset is to offset the angle difference between the black marker on the sub-reflector and the optical sensor.

**DiSEqC Level** The DiSEqC level is to distinguish 0KHz tone and 22KHz tone.

**Track Scale** The track scale is to control the tracking speed while antenna is tracking the satellite.

**Offset RH-LH** The offset RH-LH is to offset the signal difference between RHCP and LHCP.

**Detect Level** The detect level is to set the satellite signal detection level.

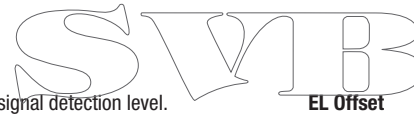

The EL offset is to offset the angle difference between the mechanical elevation angle and actual elevation angle.

**WRS Level** The WRS level is to set the WRS detection level.

**Use WRS** Use WRS is to determine whether the system uses WRS level or not. "Use WRS" and "WRS Level" are pair functions.

**Track Offset** The tracking offset is to offset the satellite signal tracking level.

**Offset Difference** Offset difference is to determine whether the system to uses "Offset RH-LH" or not. "Offset Difference" and "Offset RH-LH" are pair functions.

**Power Level** The power level is to distinguish the voltage between 13 V and 18 V.

# Intellian Satellite TV Antenna Systems

## Setting the LNB Local Frequency

It is possible to select a local frequency from ACU. It is not recommended for a novice satellite service user to use this mode.

### Case1. Single band LNB is used.

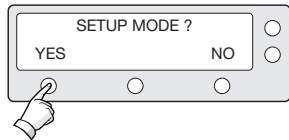

1. Press YES to enter setup mode.

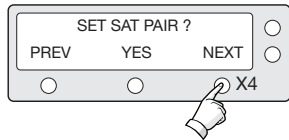

2. Press NEXT four times to enter set local frequency mode.

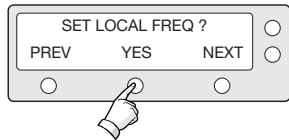

3. Press YES to set local frequency.

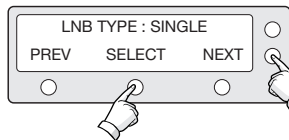

4. Select the **LNB Type\*** - SINGLE.  
PREV - Shows previous LNB type.  
SELECT - Set the displayed LNB type.  
NEXT - Shows next LNB type.  
Press ENTER to move to next screen.

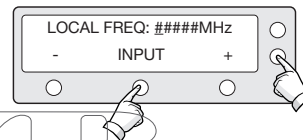

5. Input the local frequency of LNB.  
+ increases the value. - decreases the value.  
Change the underscored digit using the +/- buttons.  
Press INPUT to accept the value and move to next digit.  
Press BACK to move to previous digit.  
Press ENTER to move to next screen.



6. Press YES to accept the data.  
Press NO to cancel and return to main setup mode.

SVTB

**Case 2. Universal LNB is used (Low band local frequency-9750 MHz/ High band local frequency 10600 MHz).**

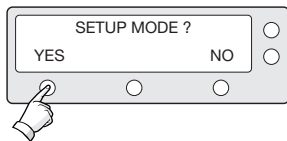

1. Press YES to enter setup mode.



5. Press YES to accept the data.  
Press NO to cancel and return to main setup mode.

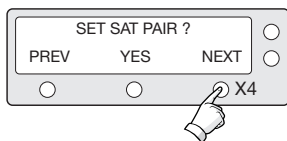

2. Press NEXT four times to enter set local frequency mode.



**LNB Type\***

**SINGLE** : Single Band LNB  
Asia 11300 MHz, Japan 10678 MHz, Korea 10750 MHz,  
America 11250 MHz

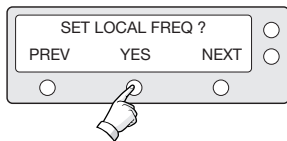

3. Press YES to set local frequency.

**UNIVERSAL** : Universal LNB  
Low band local frequency - 9750 MHz  
High band local frequency - 10600 MHz

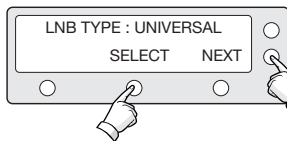

4. Select the **LNB Type\*** - UNIVERSAL.  
PREV - Shows previous LNB type.  
SELECT - Set the displayed LNB type.  
NEXT - Shows next LNB type.  
Press ENTER to move to next screen.

## Intellian Satellite TV Antenna Systems

### Setting the DiSEqC Method

DiSEqC selection can be made from ACU. It is not recommended for a novice satellite service user to use this mode.



1. Press YES to enter setup mode.



5. Press YES to accept the selection.  
Press NO to cancel and return to main setup mode.



2. Press NEXT five times to enter DiSEqC mode.



#### DiSEqC Method\*

**DO NOT USE DiSEqC** - DiSEqC is not being used.

**USE TO CHANGE BAND** - DiSEqC is being used to change to low and high band.

**USE TO CHANGE SAT** - DiSEqC is being used to change tracking satellite.

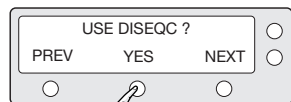

3. Press YES to use DiSEqC.

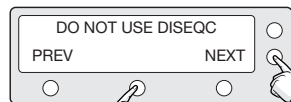

4. Select the **DiSEqC Method\***  
PREV - Shows previous DiSEqC Method.  
SELECT/ENTER - Set the displayed DiSEqC method.  
NEXT - Shows next DiSEqC Method.  
Press ENTER to move to next screen.

## Setting the Use of DiSEqC 1.2

If DiSEqC 1.2 protocol is in use on your IRD, enable the DiSEqC 1.2 setting on the ACU to process the DiSEqC 1.2 command.

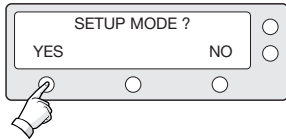

1. Press YES to enter setup mode.

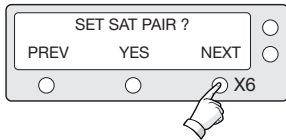

2. Press NEXT six times to enter the Use DiSEqC 1.2 menu.

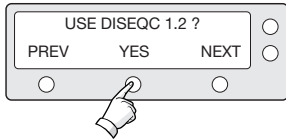

3. Press YES to set the use of DiSEqC 1.2.

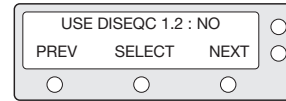

4. Set the USE DiSEqC 1.2 to a desired option\*.  
PREV - Shows previous option (YES/NO)  
SELECT/ENTER - Set the displayed option for DiSEqC 1.2.  
NEXT - Shows next option (YES/NO)  
Press ENTER to move to next screen.

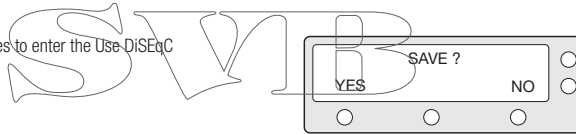

5. Press YES to accept the data.  
Press NO to cancel and return to main setup mode.

### Options for 'USE DiSEqC 1.2'

YES - Select this option if the DiSEqC 1.2 is used.  
NO - Select this option if the DiSEqC 1.2 is not used.

# Intellian Satellite TV Antenna Systems

## Setting the LNB Skew

(This menu is available only for i4P)

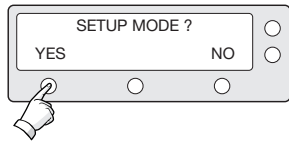

1. Press YES to enter setup mode.

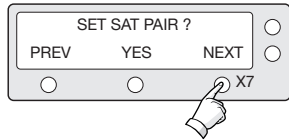

2. Press NEXT seven times to enter the Set LNB Skew menu.

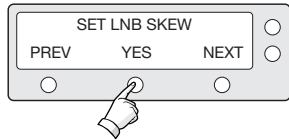

3. Press YES to set the LNB Skew menu.

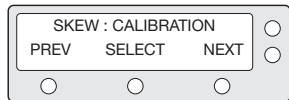

4. Press SELECT to calibrate LNB skew angle or press NEXT to enter 'Skew: Manual' option.

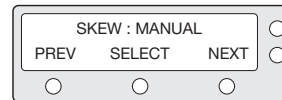

5. Press SELECT to set the LNB skew angle manually.

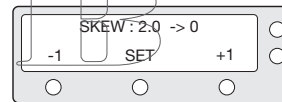

6. Press SET to save the changed LNB skew angle.

SWP



## Display Versions

This sequence enables you to see what version of antenna and ACU software are installed on your system.

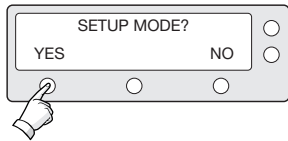

1. Press YES to enter setup mode.

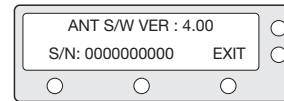

5. Antenna software version and S/N are shown.  
Press EXIT to return to main setup mode.

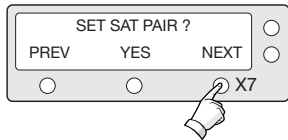

2. Press NEXT seven times to enter view version mode .

(\*i4P : Press NEXT eight times)

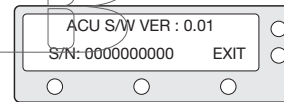

6. ACU software version and S/N are shown.  
Press EXIT to return to main setup mode.

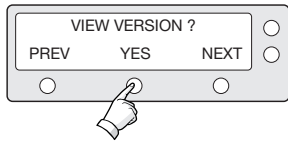

3. Press YES to view version.

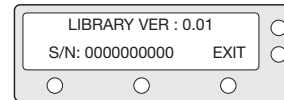

7. Library version and S/N are shown.  
Press EXIT to return to main setup mode.

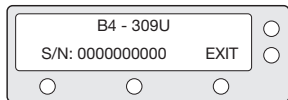

4. Antenna product name and S/N are shown.  
Press EXIT to return to main setup mode.

# Intellian Satellite TV Antenna Systems

## Display Power

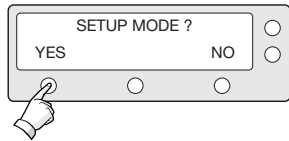

1. Press YES to enter setup mode.

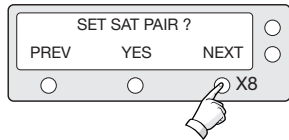

2. Press NEXT eight times to enter view power mode.

(\*14P : Press NEXT nine times)

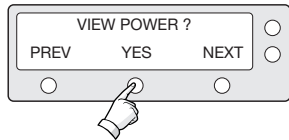

3. Press YES to view power.

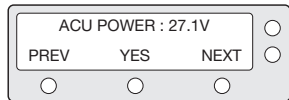

4. ACU voltage is shown.  
Press any key to return to main setup mode.

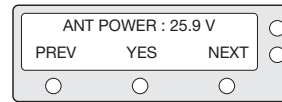

5. Antenna voltage is shown.  
Press center soft key to view IRD Voltage and frequency.  
Press EXIT to return to main setup mode.

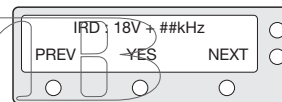

6. IRD voltage and frequency are shown.  
Press EXIT to return to main setup mode.

## Setting Remote Control

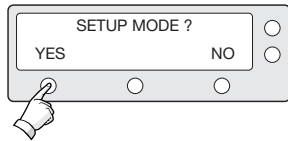

1. Press YES to enter setup mode.

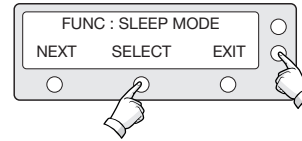

5. SELECT/ENTER - Registers a key on remote control.

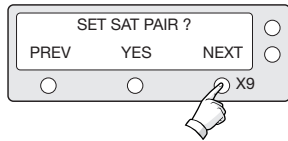

2. Press NEXT nine times to enter remote control setting mode .  
(\*14P : Press NEXT ten times)

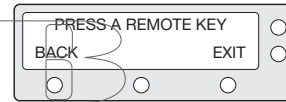

6. Point remote control to ACU.  
Press any key on remote control for selected function and press the same key again for confirmation. Press BACK to move to previous screen.  
Press EXIT to return to main setup mode.

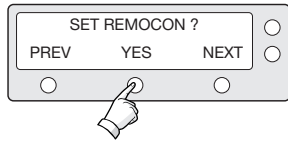

3. Press YES to set remote control.



7. If failed to press the same key twice, TRY AGAIN will be displayed.

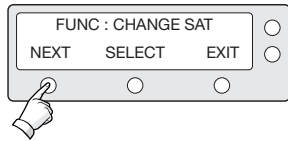

4. Select the **Function\***  
NEXT - Shows next function.

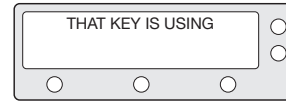

8. If failed to register a free key, KEY IS USING will be displayed.

## Intellian Satellite TV Antenna Systems

---

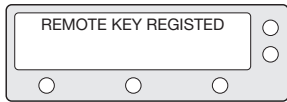

9. REMOTE KEY REGISTERED will be displayed if key has been properly registered.

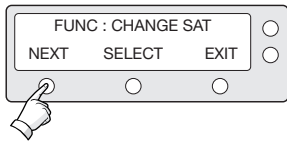

10. Press NEXT to shows next function.  
Press EXIT to return to main setup mode.

S V I B

### Function\*

CHANGE SAT - Change the target satellite.

SLEEP MODE - Enter sleep mode.

CLEAR REGISTERED KEY - Clear registered key.

## Setting Antenna Go Position

The antenna can be controlled manually by using the ACU.

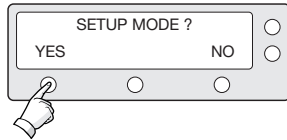

1. Press YES to enter setup mode.

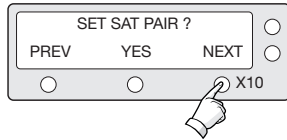

2. Press NEXT ten times to enter antenna go position mode.  
(\*14P : Press NEXT eleven times)

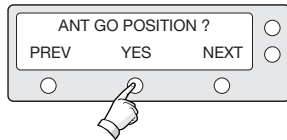

3. Press YES to go position.

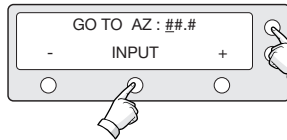

4. Input position value for azimuth (AZ) axis.  
+increases the value. - decreases the value.  
Change the underscored digit using the +/- buttons.  
Press INPUT to accept the value and move to next digit.  
Press BACK to move to previous digit.  
Press ENTER to move to next screen.

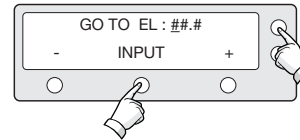

5. Input position value for elevation (EL) axis.  
+ increases the value. - decreases the value.  
Change the underscored digit using the +/- buttons.  
Press INPUT to accept the value and move to next digit.  
Press BACK to move to previous digit.  
Press ENTER to move to next screen.

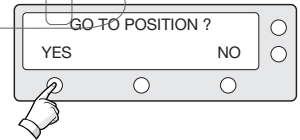

6. Press YES to move the antenna to input position.  
Press NO to return to the Antenna Go Position mode.

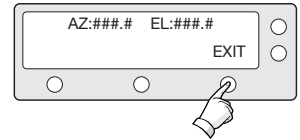

7. Press EXIT to return to main setup mode.

# Intellian Satellite TV Antenna Systems

## Setting Antenna Move Step

The antenna can be moved by 1° step manually by using ACU.

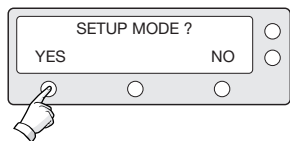

1. Press YES to enter setup mode.

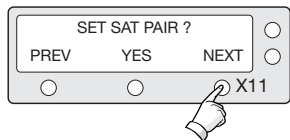

2. Press NEXT eleven times to enter antenna move step mode.

(\*14P : Press NEXT twelve times)

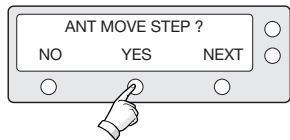

3. Press YES to move step.

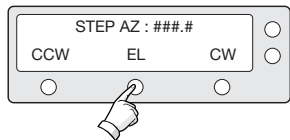

4. Move the antenna in the AZ axis.  
CW - Move the antenna clockwise.  
CCW - Move the antenna counter clockwise.  
EL - Go to elevation control screen.

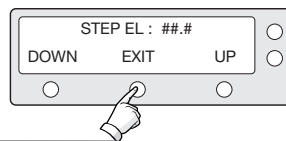

5. Move the antenna in the EL axis.  
UP - Move the antenna up.  
DOWN - Move the antenna down.  
EXIT - Return to antenna move step mode.



## Executing Antenna Diagnosis

The antenna status can be checked by reviewing the results of the diagnostic self-test of the antenna. Refer to the following codes to understand the test results.

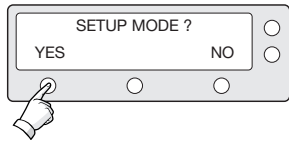

1. Press YES to enter setup mode.

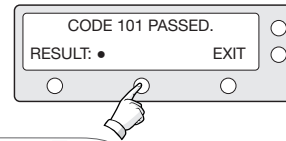

5. **CODE\*** 101 has passed.  
Press EXIT to return to main setup mode.

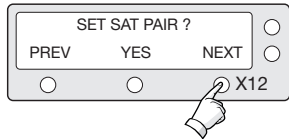

2. Press NEXT twelve times to enter antenna diagnosis mode.

(\*i4P : Press NEXT thirteen times)

# SVIB

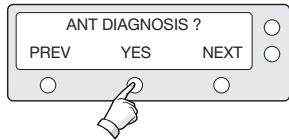

3. Press YES to diagnose antenna.

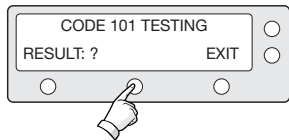

4. CODE 101 is being tested.  
Press EXIT to return to main setup mode.

## Intellian Satellite TV Antenna Systems

---

### CODE\*

**CODE 101** Data communication between antenna and antenna control unit is tested. If failed, check the RF cable.

**CODE 102** AZ CW limit is tested.  
If failed, check the limit sensors, motor and belt for AZ axis.

**CODE 103** AZ CCW limit is tested.  
If failed, check the limit sensors, motor and belt for AZ axis.

**CODE 104** EL axis is tested.  
If failed, check the limit sensors, motor and belt for EL axis.

**CODE 105** Sub reflector is tested.  
If failed, check the sub reflector.

**CODE 106** LNB is tested.  
If failed, check the LNB and control board.

**CODE 107** Skew System is tested.  
If failed, check the control board, skew motor, and skew sensor.

**CODE 108** Antenna Input Power is tested.  
If failed, check the RF cable.

**CODE 109** ACU Power is tested.  
If failed, check the ACU power cable and Input DC power.

**CODE 110** IRD Power is tested to IRD cable and IRD power.  
If failed, check the ACU to IRD cable and IRD power.

**RESULT**

- Test is passed.

**STATUS**

- Test is skipped.
- ? Test is under process.

Number refers to an error code  
(●●3●●● -●●●) 3 means error code 103.





## Setting Region

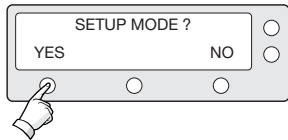

1. Press YES to enter setup mode.

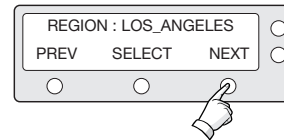

5. Select the **Region\***.  
PREV - Shows previous region.  
SELECT - Set the displayed region.  
NEXT - Shows next region.

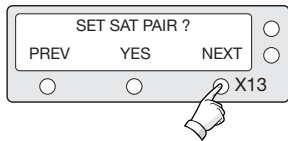

2. Press NEXT thirteen times to enter load region information mode.

(\*i4P : Press NEXT fourteen times)

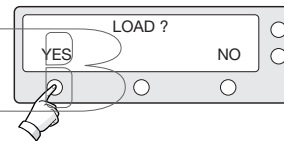

6. Press YES to load region information.  
Press NO to cancel and return to main setup mode.

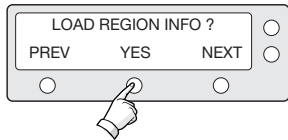

3. Press YES to load region information.



7. Loading selected region information.

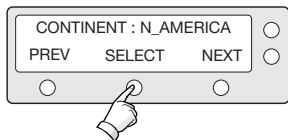

4. Select the **Continent\***.  
PREV - Shows previous continent.  
SELECT - Set the displayed continent.  
NEXT - Shows next continent.

**Continent\***  
N. AMERICA, S.AMERICA, EUROPE, ASIA.

**Region\***  
NEW YORK, MIAMI, UK, JAPAN, and etc.

# Intellian Satellite TV Antenna Systems

---

## Resetting to Factory Default Parameters

This will restore the antenna back to factory default setting.

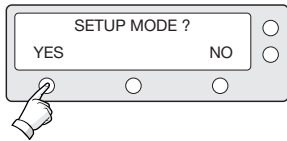

1. Press YES to enter setup mode.

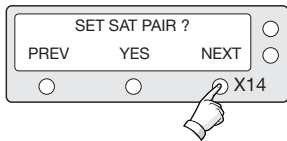

2. Press NEXT fourteen times to enter Default setting mode.

(\*I4P: Press NEXT fifteen times.)

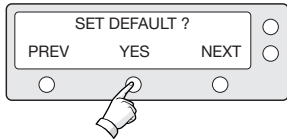
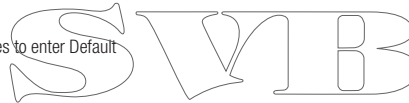

3. Press YES to set default parameters.

# ANTENNA CONTROL SOFTWARE

## Introduction to Aptus®

Intellian's new Antenna PC Controller Software, Aptus® is a next-generation graphically based antenna remote control software. The Aptus® allows users to easily and conveniently set up the antenna by using a personal computer.

The minimum PC hardware and software requirements to install and run Aptus® are as below.

### Hardware

Hardware	Requirements
CPU	Intel® Pentium® 4 or higher
Memory	512MB or higher
Video Card	DirectX9.0 or higher supported
	H/W acceleration supported
	Video Memory 128MB or higher
HDD	1GB or higher

### Operating System and Software

Software	Requirements
Operating System	Windows XP SP or higher
Framework	Microsoft.Net Framework 3.5 Service Pack 1 or higher

## Software Installation

Double click the 'Aptus Setup.exe' icon  to install Aptus® directly onto your computer/ laptop. The InstallShield Wizard will guide you through the program setup process. The installation routine provides an icon on the desktop.

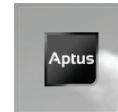
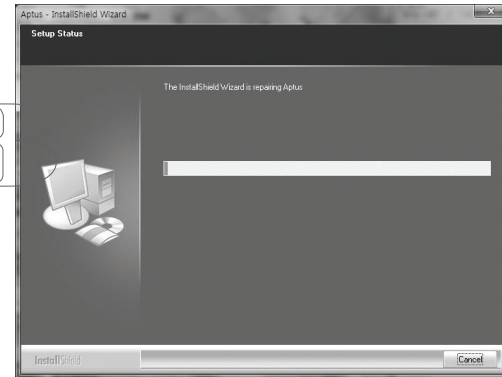

Click the icon to start the software. In addition, Intellian also provides patch files for software upgrade.

### PC to ACU Communication Setup

#### Starting Aptus®

Double-click the Aptus® desktop icon, then Communication Window appears to establish the data communication between your PC and the ACU. Select options of connection method to access your ACU either through the Serial Port Communication or the Network Communication (TCP/IP).

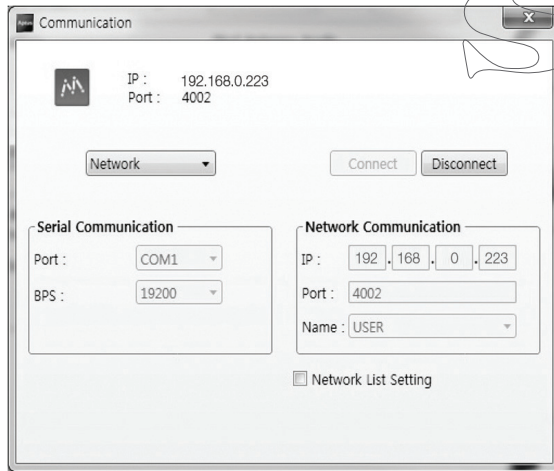

### Establish a data communication

#### Access ACU through Serial Communication

1. Connect a 9 pin Serial cable between the PC INTERFACE connector on the ACU and the 9 pin Serial port on the PC.
2. Select Serial at communication type combo-box.
3. The baud rate of the ACU is 19200 for i-series.
4. Select a COM port which is not occupied by other devices.
5. Click the Connect button.

#### Access ACU through Network Communication (TCP/IP)

1. Connect your PC to the Ethernet Port or via Wi-Fi. (Turn off the wireless connection while using the Ethernet port.)
2. Select Network at communication type combo-box.
3. Enter in the ACU's IP address  
(Factory default - Ethernet connection: 192.168.0.223 / Wi-Fi connection : 192.168.1.223)
4. Enter in the ACU's port number (Factory default : 4002)

---

**Note:** If the remote access PC is located in the same network group with the ACU, the ACU can be accessed through the internal IP address. But, if the remote access PC is located outside of the network group, the ACU's IP address should be changed to the IP address assigned by the network service provider.

---

## Auto Update

Intellian Aptus® checks and notifies the latest version when it is started to maintain up to date software version by AutoUpdate function.

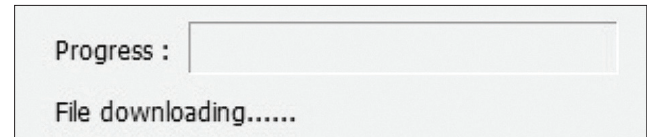
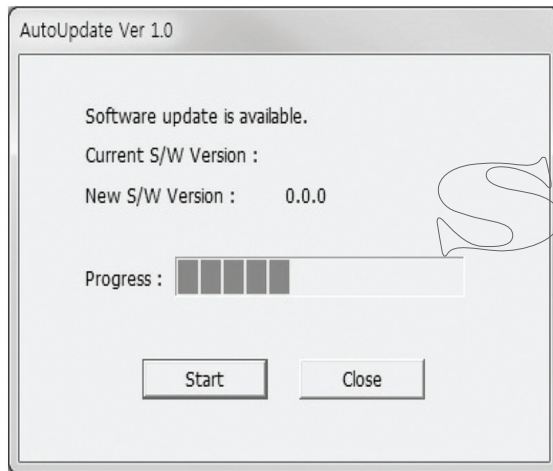

5. When file downloading is finished, “installing...” message is displayed and Aptus patch runs and the installation starts by InstallShield.
6. Click the “Finish” button when InstallShield installation is finished, then “Run the Aptus” message is displayed and Aptus runs and AutoUpdate is automatically finished.

1. When Aptus® is started, it automatically checks the latest software version from the server and runs AutoUpdate if new version is available.
2. Current software version information is displayed.
3. It notifies new software version information.
4. When you click the “start” button, “File downloading...” message is displayed while downloading files from the server.

## Toolbar Menus

The toolbar menus at the top of the screen display command buttons of the most commonly used functions of the Aptus®. The toolbar menu consists of 6 main menus; Quick (for quick launch of functions), File (not used on i-series), View (for user layout and work view), Connection (for communication), Util (not used on i-series) and Help (for reporting problems and information check) .



### ① Quick



**Setup:** enters Setup mode.



**Restart:** exits Setup mode and restarts the antenna.



**Reboot:** reboots the antenna.



**Get Ant. Info:** obtains the information stored in the antenna



**Save Satellite:** Not used on i-Series.

② File : Not used on i-Series.

③ View



- **User Layout:** displays the layout list that the user has previously stored by using Layout Manager. If you select a layout in this list, the selected layout will be constructed in Work View screen. The 'Basic layout' is provided by default.

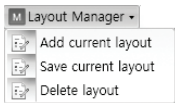

- **Layout Manager:** provides the user with add, delete, and save functionalities in order to manage the user's layouts.
  - Selecting 'Add current layout' opens a pop up window. Type in a desired name of current layout and click Add, then the new name of the current layout will be saved to the list under User Layout menu.
  - When changes are made to the current layout, select 'Save current layout' option. The current layout will be saved with changes.
  - To remove a layout, select 'Delete layout' option. Select a desired layout to remove on the pop up window, then click 'Delete'. Close the window by clicking on 'Close'. The selected layout is removed from the User Layout list.

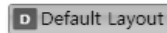

- **Default Layout:** returns the current layout to the default layout.

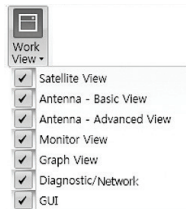

- **Work View:** displays a list of seven pre-constructed Work View Tabs (Satellite View, Antenna Basic View, Antenna Advanced View, Monitor View, Graph View, ACU System View, and Antenna UI View) and also provides the Activate / Close functionalities for each view tab. Activate the work view tab by ticking the checkbox next to it.

## Intellian Satellite TV Antenna Systems

---

### ④ Connection



At any time, data communication channel can be re-established between Serial and Network connection. Selecting Comm. Button will display Communication Window to connect to the ACU via Serial or Network communication.

### ⑤ Util : Not used on i-Series.

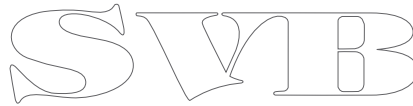

### ⑥ Help



- **Report:** provides e-mail contact to Intellian technical support team to let the user report problems at any time.



- **Information:** displays the information of current Aptus<sup>®</sup> software version.



## System Property Status Dashboard

The property status dashboard on the left pane of the screen provides the antenna status, the availability of TX transmission, signal level, GPS status, software information, product information and error status to be monitored quickly.

The screenshot displays a vertical list of system property status widgets:

- 1 Antenna Status:** Setup (button)
- 2 Tracking Satellite:** KOREA3BS (radio), A (button), KOREA3CS (radio), B (button)
- 3 Signal Level:** 274 (value), 274 (bar)
- 4 GPS:** 129.04 E 35.04 N (coordinates)
- 5 Voltage:** Antenna : 23.0V, ACU : 24.5V
- 6 Software Information:** Ant. Version : V4.67, ACU Version : V6.29
- 7 Product Information:** System Model : 14, Ant. Name : B4-419J, Ant. Serial : S0413120912
- 8 Diagnostic Error Report:**

① **Antenna Status:** Displays the status of the current mode of the antenna.

- Search: Antenna is searching the selected satellite.
- Tracking: Antenna is tracking the target satellite.
- Initialize: Antenna or ACU is initializing.
- Setup: Antenna is in SETUP mode.
- Sleep: Antenna is in Sleep mode.
- Unwrap: Antenna is unwinding/winding the cable in the antenna.

② **Tracking Satellite**

Display or set current tracking satellite and tracking information. Up to three satellites can be selected.

③ **Signal Level**

The “Red” line indicates the signal “Detect Level Threshold” and the “Orange” line indicates the signal “Tracking Level Threshold”. If the signal level is higher than the tracking level threshold, the signal level bar will display “Blue” color. If the signal level is lower than the tracking level threshold, the signal level bar will display “Orange” color and the antenna will stay in searching mode.

---

**Note:** If the signal level is not higher than the tracking threshold, decrease the detect and tracking level.

---

## Intellian Satellite TV Antenna Systems

---

- ④ **GPS:** Displays the current GPS location from the Antenna information.  
The status light flashes green if the system receives a correct input of the GPS.

GPS ● 129.04 E 35.04 N

- ⑤ **Voltage:** Displays the antenna and the ACU voltage information.

**Voltage**  
Antenna : 23.0V  
ACU : 24.5V

- ⑥ **Software Information:** Displays the antenna and the ACU firmware versions

**Software Information**  
Ant. Version : V4.67  
ACU Version : V6.29

SVMB

- ⑦ **Product Information:** Displays the antenna and ACU serial numbers, antenna model and ACU model.

**Product Information**  
System Model : I4  
Ant. Name : B4-419J  
Ant. Serial : S0413120912

---

⑧ **Diagnostic Error Report**

The square button next to the Diagnostic Error Report turns red when the system receives an error. Click the button to see a Diagnostic Report.

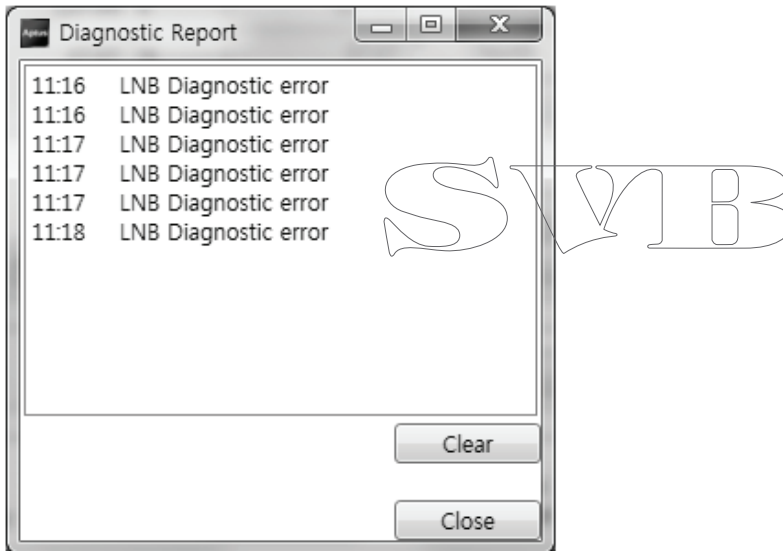

## Work View Tabs

Aptus® provides seven Work View Tabs (Antenna Basic View, Antenna Advanced View, Satellite View, Monitor View, Graph View, Diagnostic /Network View, and GUI View) to manage the Antenna and the Satellite configuration.

How to modify the settings on Work View;



1. Enter the Setup mode by clicking Setup icon.

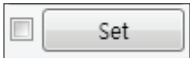

2. Tick the checkbox next to the “Set” button to modify the settings.

3. Enter the desired value then press the Set button to save the settings.

### 1. Antenna – Basic Info.

This view tab provides information on the Antenna’s Current GPS location, Skew Information, and the Antenna’s Angle. This view tab uses the Antenna’s AZ and EL information in order to provide a dynamic graphic user interface (UI).

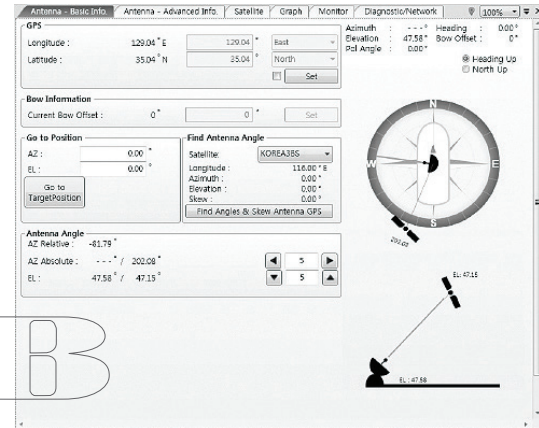

- GPS: displays and sets current antenna’s GPS.
- Bow Information: not used on i-series.
- Go to Position : The current position (angle) of the antenna is displayed. Push the “Go to Target Position” button after keying in the desired angle to move the antenna to target position.
- Find Antenna Angle: displays and sets the current antenna angle. Select a desired satellite from the drop-down menu, then longitude, azimuth, elevation and skew information are displayed.
  - Find Angles & Skew Antenna GPS: finds the current antenna angles and skew angle in relation to the longitude (orbit position) of the antenna’s current GPS.

- Antenna Angle: displays and sets current antenna's absolute and relative AZ (azimuth) position, EL (elevation) position and polarization (between Linear and Circular). You can move antenna azimuth and elevation position and LNB Pol angle by using the arrows or inputting a value to find the desired satellite manually.

## 2. Antenna – Advanced Info.

This view provides information on Parameter Setting, Threshold Setting, and Flag Setting.

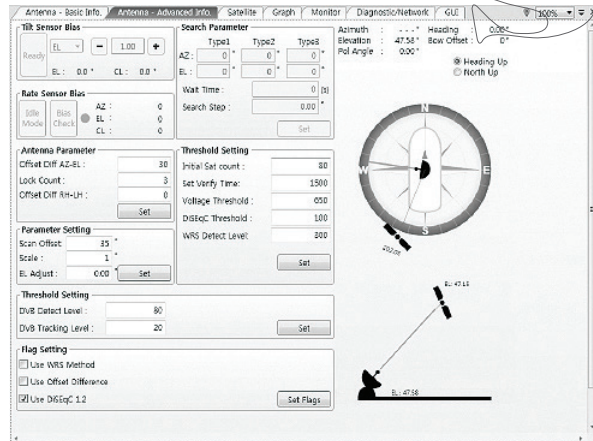

-Tilt Sensor Bias: not used on i-series.

- Rate Sensor: not used on i-series

- Antenna Parameter: used to set the antenna parameter settings.

- Offset Diff AZ-EL: The offset AZ-EL is to offset the angle difference between Azimuth and Elevation.

- Lock Count: The Lock Count is to set the number of checking signal lock.

- Offset Diff RH-LH: The offset RH-LH is to offset the signal difference between RHCP and LHCP.

- Parameter Setting: used to set the control parameter settings.

- Scan Offset: The scan offset is to offset the angle difference between the black marker on the sub-reflector and the optical sensor.

- Scale: The scale is to control the tracking speed while antenna is tracking the satellite.

- EL Adjust: The elevation adjustment is to offset the angle difference between the mechanical elevation angle and actual elevation angle.

- Threshold Setting: set the threshold level for detecting and tracking the satellite signal.

- DVB Detect Level: displays and sets signal detection threshold level when DVB tracking mode is in use.

- DVB Tracking Level: displays and sets signal

## Intellian Satellite TV Antenna Systems

### - Threshold Setting

- Initial Sat Count: Set the threshold count for maintaining tracking.
- Set Verify Time: Set the time of verifying whether the signal detected is the signal of target satellite.
- Voltage Threshold: Set the voltage threshold. The voltage threshold is to distinguish the voltage between 13V and 18V.
- DiSEqC Threshold: Set the DiSEqC threshold. The DiSEqC threshold is to distinguish the OKHz tone and 22KHz tone.
- WRS Detect Level: Set the WRS detection level.

### - Flag Setting

- Use WRS Method: Use WRS method is to determine whether the system uses “WRS Detect Level” or not. Use WRS method and “WRS Detect Level” are pair functions.
- Use Offset Difference: Use offset difference is to determine whether the system uses “Offset Difference” or not. Use Offset Difference and “Offset Difference” are pair functions.
- Use DiSEqC 1.2: Use DiSEqC 1.2 is to determine whether the system uses “DiSEqC 1.2” or not.

## 3. Satellite (Satellite View)

The name, longitude, verification method of the satellite and LNB local frequency are displayed.

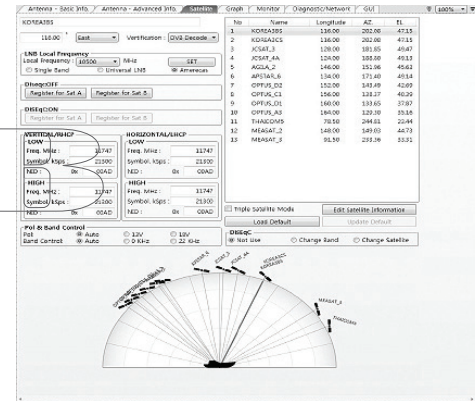

- LNB Local Frequency: Displays or sets LNB local frequency and its corresponding LNB voltage supplied. You may select pre-programmed LNB LO settings from the drop down list.

---

- Dual Satellite Mode/ Triple Satellite Mode: Registers the target satellite.

- Pushing 'Register for Sat A' or 'Register for Sat B' button after selecting the satellite in the list box makes it possible to register A or B in Dual Satellite Mode.

- Pushing 'Register for Sat A' or 'Register for Sat B' or 'Register for Sat C' button after selecting the satellite in the list box makes it possible to register A or B or C in the Triple Satellite Mode.

- Transponder information consists of frequency, symbol and NID (Network ID) of a transponder in tracking the satellite. There are four groups of transponder information. 'Vertical/RHCP' is applied when the IRD supplies 13V, and 'Horizontal/LHCP' is applied when the IRD supplies 18V. 'LOW' is applied when DiSEqC signal is not detected from IRD. 'HIGH' is applied when the DiSEqC signal is detected from the IRD. After modifying information, press the 'Edit Satellite Information' button, then new information is updated in the antenna.

- Pol & Band Control: The "Pol" controls 13V (Vertical/RHCP band) or 18V (Horizontal/ LHCP band). The "Band" controls DiSEqC 0KHz tone (Low band) and 22KHz tone (High band). After modifying information, press 'Edit Satellite Information' button, then new information is updated in the antenna.

- Triple Satellite Mode: To select between Dual-Sat mode and Triple-Sat mode, tick the 'Triple Satellite Mode' box at the bottom of the screen.

- Edit Satellite Information: push the "Edit Satellite Information" button to update the information after modifying values.

- Load Default: Push the "Load Default" button to select a regional library file \*.rif according to your region.

- Update Default: After loading a regional library file \*.rif, push the "Update Default" button to update the system.

- DiSEqC: When the operation method of DiSEqC is selected to "Change Band", DiSEqC may be used for updating the local frequency and to "Change Satellite", for updating the target satellite.

## Intellian Satellite TV Antenna Systems

### 4. Graph

This view provides information on Signal, Elevation (EL), Absolute AZ (Azimuth), Relative AZ, Heading, AZ and EL in Single or Multi graph formats.

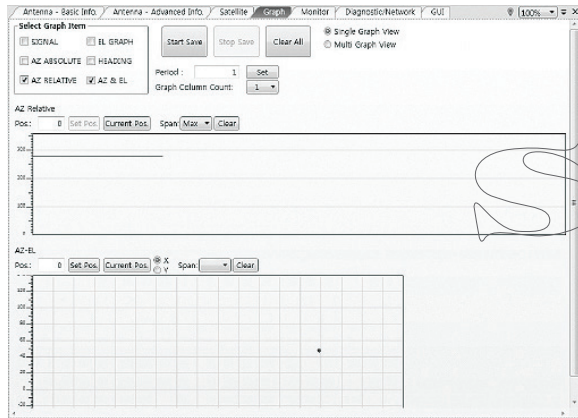

- Select Graph Item: shows the graphs of only the checked item(s) in a Single or Multi Graph View.

- Single Graph View: shows Graph Views per each single Graph Item selected in 'Select Graph Item'.

- Multi Graph View: shows one large integrated Graph View of multiple Graph Items selected in 'Select Graph Item'.

- Start/Stop Save: the chosen item is saved within the data log. The data log which stores the information displayed in the graphs can be later used for a service technician to find out a cause of any possible problem to the antenna.

- Clear All: clears everything drawn on the Graph View window.

- Set Pos.: sets the current position as center value of each Graph Item.

- Current Pos.: moves to the location according to values of each Graph Item.

- Span: sets the Display Range(s) of each corresponding Graph Item.

- Period: displays and sets the signal sampling rate.

- Graph Column Count: makes all Graph Views show in either one or two-column format.



## 5. Monitor

This view provides a UI which can monitor all data that has been received from the ACU.

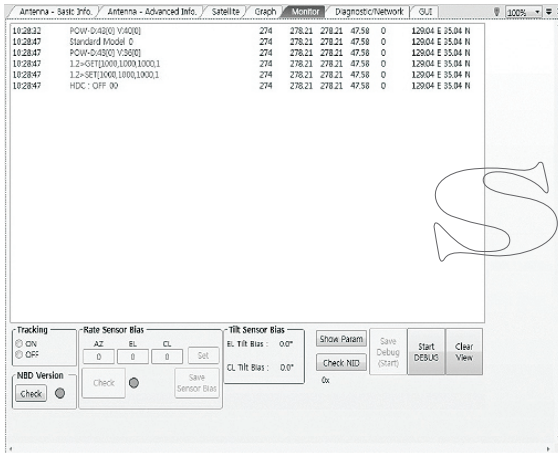

- Tracking: not used on i-series.

- Rate Sensor Bias: not used on i-series.

- Tilt Sensor Bias: not used on i-series.

- Show Param: shows the current antenna parameters.

- Check NID: verifies the NID (network ID) of the current tracking transponder. Press the NID button to obtain the NID only if the antenna is locked onto the desired satellite.

- Start Debug: starts the debug log of the antenna. The debug message will be displayed once the debug button is pressed.

- Stop Debug: stops debug logging of the antenna.

- Save Debug (Start/Stop): starts or stops saving the debug log. This button is enabled once the Start Debug button is pressed.

- Clear View: clears the debug message or log data in monitoring window.

### 6. Diagnostic / Network

This view provides Antenna Diagnostic Testing and Network Settings.

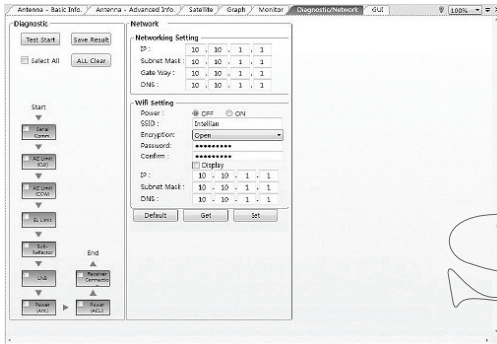

SVIB

- Diagnostic : select to run a full diagnostic test or single diagnostic test. “Green” indicator is displayed for the test under progress. “Blue” indicates the test result as Pass while “Red” indicates the result as Fail. “Yellow” indicates the test has been skipped.

- Serial Comm.: tests the data communication between the antenna and the ACU.
- AZ Limit (CW) : tests the azimuth limit (CW)
- AZ Limit(CCW) : tests the azimuth limit(CCW)
- EL Limit: tests the elevation limit.
- Sub-Reflector: tests the Sub-Reflector.
- LNB: tests the LNB.

- Power (Ant.): tests the antenna power to see whether or not it is within the nominal operating range.
- Power (ACU): tests the ACU power to see whether or not it is within the nominal operating range.
- Receiver Connection: tests the data communication between the antenna and the receiver.

• Network Setting:

IP	the network IP address.
Subnet Mask	the network subnet mask.
Gate Way	the gateway for network.
DNS	the DNS address.

• Wifi Setting:

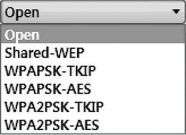
Power	select to turn on or off Wifi network function.
SSID	the SSID is the network name shared among all devices in a wireless network. The SSID must be identical for all devices in the wireless network. It is case-sensitive and must not exceed 8 alphanumeric characters, which may be any keyboard character. Make sure this setting is the same for all devices in your wireless network.
Encryption	<p>i-series supports different types of encryption settings for your network.</p> 
Password	the password should be 8 alphanumeric characters.
Confirm	enter the password again to confirm it.
IP	the current wireless IP address.
Subnet	the current wireless subnet mask.
DNS	the current default wireless DNS address.

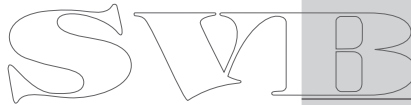

- Default: initializes the network and Wi-Fi settings.

**Note:** When the setting is changed, it needs to be re-connected with the modified IP address.

# Intellian Satellite TV Antenna Systems

## 7. GUI

This view shows a graphical representation of the current antenna position which allows you to easily identify whether or not the antenna is aligned properly to the target satellite or is in a block zone. In addition, this view shows the current satellite that the antenna is pointed towards and the satellites that are located at a 180° arc on the horizon, according to the current position.

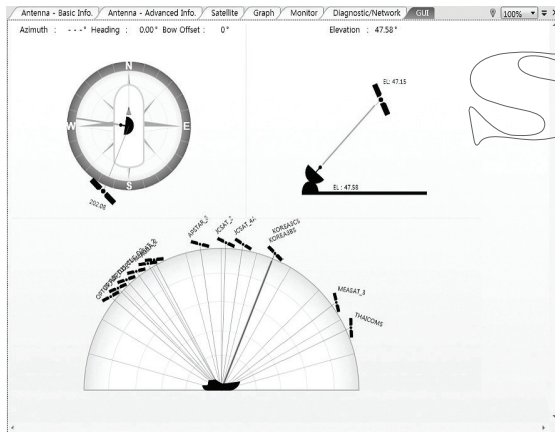

**Note:** Based on the satellite EIRP footprint and the size of the antenna, you may not be able to track all the satellites visible in 180° arc.

## 8. Work View Functions

The seven Work View Tabs displayed in the Work View can be arranged in customized layouts.

- Layout Formatting

- Each of the Work View Tab can be separated from the rest Tabs. Click and hold the left mouse button on the Work View Tab's header and then drag a desired Tab out. When a Work View Tab is separated from the rest of your Work View Tabs, again click and hold the left mouse button on the Work View Tab's header to display a cross-shaped Navigator icon. While holding the mouse button, bring the selected Work View Tab closer to the Navigator icon and release the mouse button at your desired position (top, left, right or bottom arrow). This time, the selected Tab will be moved to the desired position.

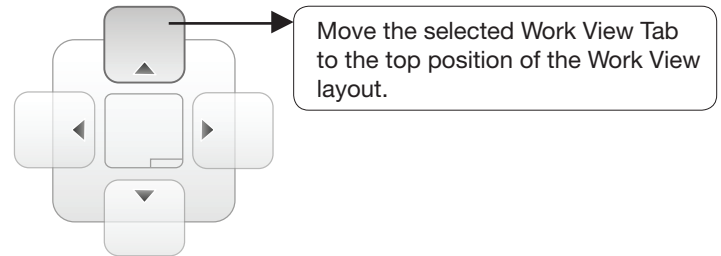

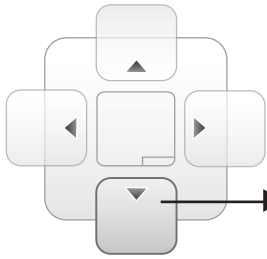

Move the selected Work View Tab to the bottom position of the Work View layout.

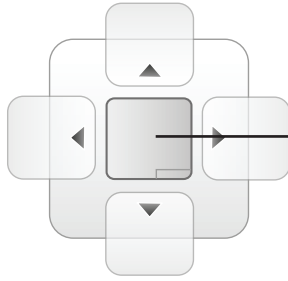

Move the selected Work View Tab to the center position of the Work View layout.

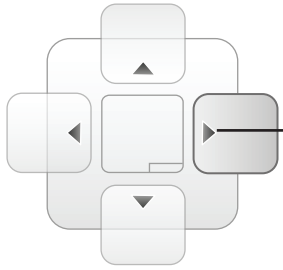

Move the selected Work View Tab to the right position of the Work View layout.

# SWP

- Horizontal or Vertical Tab Group  
The Work View Tabs can be also aligned horizontally or vertically. Without dragging them out, right-click the mouse button on a desired Tab header and select 'New Horizontal Tab Group' or 'New Vertical Tab Group' option. Selecting 'New Horizontal Tab Group' will separate a selected Tab from the rest of other Tabs then arrange it in a horizontal format. Likewise, selecting 'New Vertical Tab Group' will separate a selected Tab from the rest of other Tabs then arrange it in a vertical format.

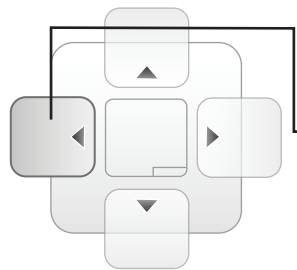

Move the selected Work View Tab to the left position of the Work View layout.

- Closing the Work View Tab  
To close the Work View Tab, right-click the mouse button on a desired Tab header and select 'Close' option in the drop down list. To close all Work View Tabs except the selected Tab, select 'Close All But This' option in the drop down list.

## Intellian Satellite TV Antenna Systems

---

### - Zoom Tool

Using the Zoom tool, you can easily select the magnification you want by using Zoom In and Zoom Out bar, and Fit in Work View button.



Fit Work View Button: fits the current view to the Work View window size. The button toggles between the fit view and the previous view.

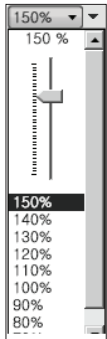

Zoom In and Zoom Out Bar: zooms in and out to expand and reduce the View to the desired size. (The zoom changes in 10% increments.)



View Switch Button: displays a list of the current views in a list. Choosing one of these views will display the selected view in the Work View window.



View Name Button: displays the current Work View name.



Close View Button: closes the current view.

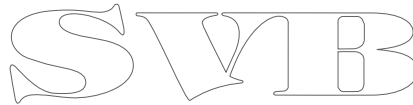

---

# Preparation for Transportation

This is to describe how to prepare the antenna internally for transportation.

The following procedures to secure the antenna shall be strictly observed to protect it from being damaged during transportation.

1. Refer to the drawing on the right.
2. Rotate antenna left and right slowly until the limit switch is pressed.
3. Turn the antenna by 360° to the reverse direction.
4. Insert the shipping foams in front of the dish and back side of the pedestal to secure the pedestal in position with the bottom radome.
5. Cover upper part of radome. Be careful not to touch the reflector when assembling upper part of radome.
6. Pack Intellian i3/i3L/i4/i4P into the original package box.

---

**Note :** Don't rotate it quickly, or you may damage the antenna limit system.

---

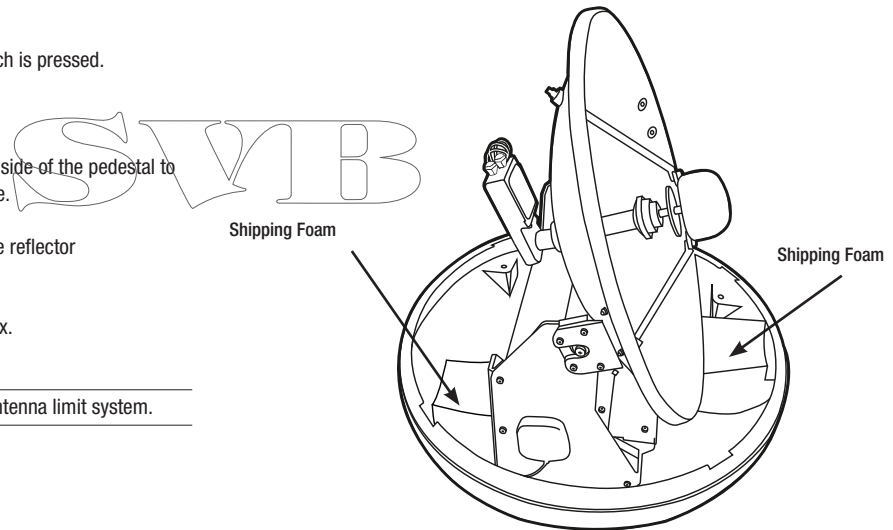

**Figure 38 : Preparation for Transportation**

# Warranty

This product is warranted by Intellian Technologies Inc., to be free from defects in materials and workmanship for a period of THREE (3) YEARS on parts and ONE (1) YEAR on labor performed at Intellian Technologies, Inc. service center from the purchased date of the product.

Intellian Technologies, Inc. warranty does not apply to product that has been damaged and subjected to accident, abuse, mis-use, non-authorized modification, incorrect and/ or non-authorized service, or to a product on which the serial number has been altered, mutilated or removed.

It is required to present a copy of the purchase receipt that indicates the date of purchase for after-sales service under the warranty period. In case of failure to present the purchase receipt, the warranty period will begin 30 days after the manufacturing production date of the product purchased.

Any product which is proven to be defective in materials or workmanship, Intellian Technologies, Inc. will (at its sole option) repair or replace during the warranty period in accordance with this warranty. All products returned to Intellian Technologies, Inc. under the warranty period must be accompanied by a return material authorization (RMA) number issued by the dealer/distributor from Intellian Technologies, Inc. and a copy of the purchase receipt as a proof of purchased date, prior to shipment. Alternatively, you may bring the product to an authorized Intellian Technologies, Inc. dealer/distributor for repair.

SWIB



# Appendix : i3/i3L Technical Specification

## General

### Approvals

CE – conforms to	EU Directive 89/336/EEC
FCC – verified to	CFR47:Part 15

### Dimensions

Satellite antenna unit	43cm (17") x 44cm(17.3")
Antenna dish diameter	37cm(14.6")
Antenna control unit	17.8cm(7")x21.7cm(8.5")x5.4cm(2.1")

### Weight

Satellite antenna unit	9kg (19.8 lbs)
Antenna control unit	1.2kg (2.6 lbs)

### Environmental

Operating temperature range	-25°C to +55°C (-13°F to +131°F)
Storage temperature range	-40°C to + 80°C (-40°F to + 176°F)
Humidity limit	95% R.H

Power requirements	9~30 V DC
--------------------	-----------

Power consumption	Typ. 30W, Max. 50W
-------------------	--------------------

## Antenna system performance

Frequency	Ku-band (10.7 to 12.75 GHz)
-----------	-----------------------------

Minimum EIRP	50dBW
--------------	-------

Azimuth range	680°
---------------	------

Elevation range	+10° ~ +80°
-----------------	-------------

Ship's motion	Roll ±25°
	Pitch ±15°

Roll and pitch response rate	60° per second
------------------------------	----------------

Turn rate	60° per second
-----------	----------------

## Appendix : i4/i4P Technical Specification

### General

#### Approvals

CE – conforms to	EU Directive 89/336/EEC
FCC – verified to	CFR47:Part 15

#### Dimensions

Satellite antenna unit	50cm (19.7") x 54cm(21.2")
Antenna dish diameter	45cm(17.7")
Antenna control unit	17.8cm(7")x21.7cm(8.5")x5.4cm(2.1")

#### Weight

Satellite antenna unit	11.6kg (25.6 lbs)
Antenna control unit	1.2kg (2.6 lbs)

#### Environmental

Operating temperature range	-25°C to +55°C (-13°F to +131°F)
Storage temperature range	-40°C to + 80°C (-40°F to + 176°F)
Humidity limit	95% R.H

Power requirements	9~30 V DC
--------------------	-----------

Power consumption	Typ. 30W, Max. 50W
-------------------	--------------------

### Antenna system performance

Frequency	Ku-band (10.7 to 12.75 GHz)
-----------	-----------------------------

Minimum EIRP	49dBW
--------------	-------

Azimuth range	680°
---------------	------

Elevation range	0° ~ +90°
-----------------	-----------

Ship's motion	Roll ±25°
	Pitch ±15°

Roll and pitch response rate	50° per second
------------------------------	----------------

Turn rate	50° per second
-----------	----------------



# Intellian®

## APAC

supportAPAC@intelliantech.com

### Headquarters

Intellian Technologies, Inc.  
348-5 Chungno-Ri, Jinnwi-Myeon  
Pyeongtaek-Si, Gyeonggi-Do 451-862 Korea  
T +82 31 379 1000 F +82 31 377 6185

### Seoul Office

Intellian Technologies, Inc.  
2F Dongik Building, 98 Nonhyun-Dong  
Gangnam-Gu, Seoul 135-010 Korea  
T +82 2 511 2244 F +82 2 511 2235

## Americas

supportAMERICAS@intelliantech.com

### Irvine Office

Intellian Technologies USA, Inc.  
9004 Research Drive  
Irvine, CA 92618 USA  
T 949 727 4498 F 949 271 4183

## EMEA

supportEMEA@intelliantech.com

### Rotterdam Office

Intellian B.V.  
Bristolstraat 1, 3047AB  
Rotterdam, The Netherlands  
T +31 1 0820 8655 F +31 1 0820 8656

### Southampton Office

Intellian Ltd.  
Epsilon House, Enterprise Road, Southampton Science  
Park, Southampton, Hampshire SO16 7NS, UK  
T +44 2380 019 021 F +44 2380 767 092

## Maritime Technical Center

MTC@intelliantech.com

### Busan Office

Intellian Technologies, Inc.  
#1701, 60, Centum buk-daero,  
Haeundae-gu, Busan 612-050 Korea  
T +82 51 746 9695 F +82 51 746 9440

[intelliantech.com](http://intelliantech.com)