

KVH Industries, Inc.

TracVision® TV5



User's Guide

TracVision TV5

User's Guide

This user's guide provides all of the basic information you need to operate, set up, troubleshoot, and maintain the TracVision TV5 system. For detailed installation information, please refer to the TracVision TV5 Installation Guide.

If you have any comments regarding this manual, please e-mail them to manuals@kvh.com. Your input is greatly appreciated!

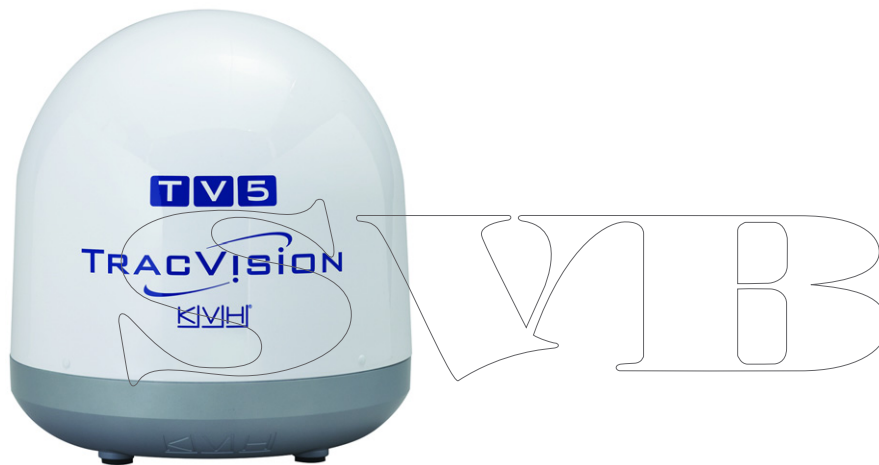

Technical Support

North/South America, Australasia:

Phone: +1 401 847-3327

E-mail: support@kvh.com

Europe, Middle East, Africa, Asia-Pacific:

Phone: +45 45 160 180

E-mail: support@emea.kvh.com

Trademark Information

TracVision, KVH, and the unique light-colored dome with dark contrasting baseplate are trademarks of KVH Industries, Inc.

All other trademarks are the property of their respective owners.

Disclaimer

Every effort has been made to ensure the correctness and completeness of the material in this document. No company shall be liable for errors contained herein. The information in this document is subject to change without notice. No warranty of any kind is made with regard to this material, including, but not limited to, the implied warranties of merchantability and fitness for a particular purpose.

The image shows the letters 'SVIB' in a highly stylized, outlined font. The 'S' is a large, bold, serif letter with a decorative flourish at the bottom. The 'V' is a simple, bold, serif letter. The 'I' is a simple, bold, serif letter. The 'B' is a large, bold, serif letter with a decorative flourish at the bottom. The letters are arranged horizontally and are rendered in a light gray outline style.

Table of Contents

1	Introduction	
	Documentation Overview	3
	Important Safety Information	4
	System Overview	5
2	Getting Started	
	Receiving Satellite TV Signals.....	11
	Avoiding Blockage	12
	Turning On the System	13
	Accessing the Web Interface	14
3	Network Settings	
	Connecting the TV-Hub to Your Onboard Network.....	17
	TV-Hub Ethernet Settings	19
	Connecting to the TV-Hub Using its Built-in Wi-Fi	20
	TV-Hub Wireless Settings	21
	Connecting Directly to the TV-Hub Ethernet Port.....	22
	Resetting Network Settings to Factory Defaults.....	23
4	Antenna Settings	
	Adjusting the LNB Skew Angle (Linear Only)	27
	Understanding Skew	29
	Using the Optional NMEA Input.....	30
	Advanced Settings	32
	Sleep Mode.....	32
	Band/Polarization Control.....	32
	Sidelobe Mode.....	33

5 Receiver Settings

Configuring a Linear Receiver for Automatic Switching	37
Configuring DIRECTV Receivers for Automatic Switching.....	38
Allowing External Access on a DIRECTV Receiver	42
Setting the Dish Type on a DIRECTV Receiver	43
Running a Check Switch Test on a DISH Network or Bell TV Receiver	45
Check Switch Mode.....	48
Activating Your Receiver(s).....	49

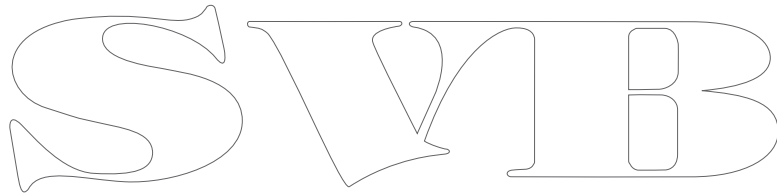
6 Satellite Settings

Selecting a Single Satellite	53
Creating a New Satellite	54
Selecting a Satellite Group	55
Creating a New Satellite Group.....	57
Changing Satellites in a Group.....	59
Changing Satellite Tracking Parameters	60

7 Switching Satellites

Automatic Satellite Switching for Linear, DISH Network, or Bell TV.....	65
Setting Up a Linear Receiver for Automatic Switching.....	66
Setting Up a DISH Network/Bell TV Receiver for Automatic Switching	67
Setting Up an IP AutoSwitch.....	68
Automatic Satellite Switching for DIRECTV.....	69
DIRECTV Coax Network Connections	70
Additional Equipment for Old DIRECTV Receivers	72
Setting Up a DIRECTV Receiver for Automatic Switching	73
Understanding DIRECTV SWM Technology	75
Selecting Automatic Switching Mode	76



Selecting the Master Receiver.....	77
Manual Satellite Switching.....	78
Tri-Americas Satellite Switching	79

8 Troubleshooting

Basic Checks	83
Status Information on the Home Page.....	85
TV-Hub Status Indicators.....	87
IP AutoSwitch Status Indicator	90
Error Messages.....	91
System Logs	95
Operational Log	96
Event Log.....	97
System Information	98
Technical Support.....	100

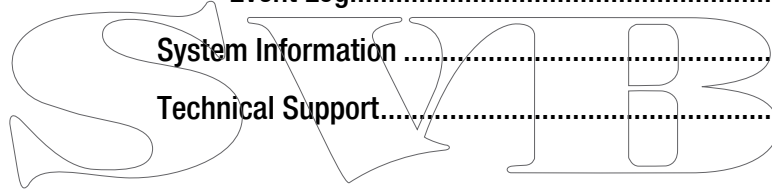

9 Maintenance

Preventive Maintenance	103
Updating the Satellite Library	104
Updating the Software.....	106
Corrective Maintenance.....	108
Restarting the System	109

A Specifications

System Specifications	113
-----------------------------	-----



1. Introduction

This section provides important safety information you need to know before using the system. It also provides an overview of the system and its documentation.

Contents

Documentation Overview	3
Important Safety Information	4
System Overview	5

SVIB



Documentation Overview

The information provided here contains complete operation, configuration, and troubleshooting details for your TracVision system.

Icons Used

The documentation for this product uses the following icon:

Icon	Description
	This is a danger, warning, or caution notice. Be sure to read these carefully to avoid injury!

Related Documentation

In addition to the Help accessible from the TV-Hub's web interface, the following documents are provided with your TracVision system:

Document	Description
Installation Guide	Complete installation instructions
Quick Start Guide	Handy quick reference guide with basic operating instructions
Installation Checklist	Form that the installer must return to validate the quality of the installation
Mounting Templates	Templates that the installer uses to lay out the mounting holes for the antenna and the TV-Hub
Warranty Statement	Warranty terms and conditions
Kitpack Contents List	List of every part supplied in the kit

Important Safety Information

For your own safety, and for the safety of your passengers and/or crew, be sure to read the following important notices.



WARNING

Risk of Electric Shock

To avoid electric shock, do not open the TV-Hub's chassis enclosure. There are no user-serviceable parts inside.



WARNING

Risk of Electric Shock

If any component of the TracVision system becomes damaged and/or no longer functions normally, disconnect it from power, secure it from unintended operation, and contact KVH Technical Support (see ["Technical Support" on page 100](#)). All repairs or modifications must be performed by a trained, KVH-certified technician.



WARNING

Risk of Explosion

Do not operate the TV-Hub (or any other electrical device) in an environment where flammable gases, vapors, or dusts are present. In addition, do not use the TV-Hub in an environment with a temperature outside its 5°F to 131°F (-15°C to 55°C) operating range.



WARNING

Risk of Electric Shock

Failure to ground the TracVision system properly may cause an unsafe floating ground condition, risking potentially lethal electric shock. Refer to the Installation Guide for details on the proper grounding of the equipment.

System Overview

Your TracVision system is a state-of-the-art, actively stabilized antenna system that delivers live satellite TV to your mobile audio/video entertainment system. A basic system is illustrated below. Refer to the Installation Guide for detailed wiring diagrams.

Figure 1-1 Basic TracVision System Diagram

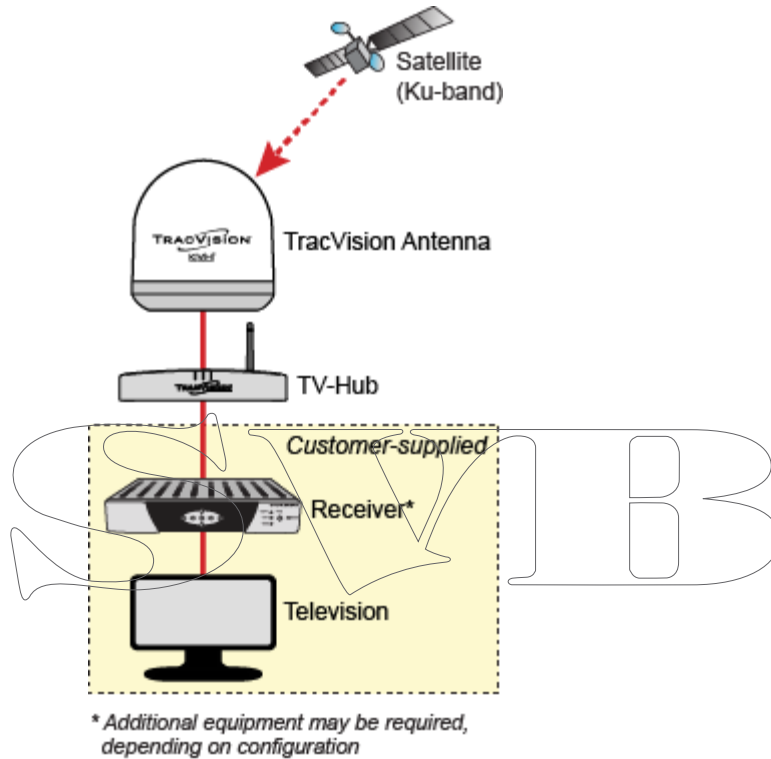

The TracVision system includes the following components:

Antenna

Housed within a protective radome, the antenna quickly acquires and tracks the desired satellite to deliver a crystal-clear television picture, even while you're on the move. Its built-in DVB-S2 technology ensures compatibility with all modern Ku-band television satellites, and its exclusive RingFire technology provides stronger signals, wider coverage, and better reception.

Figure 1-2 Antenna

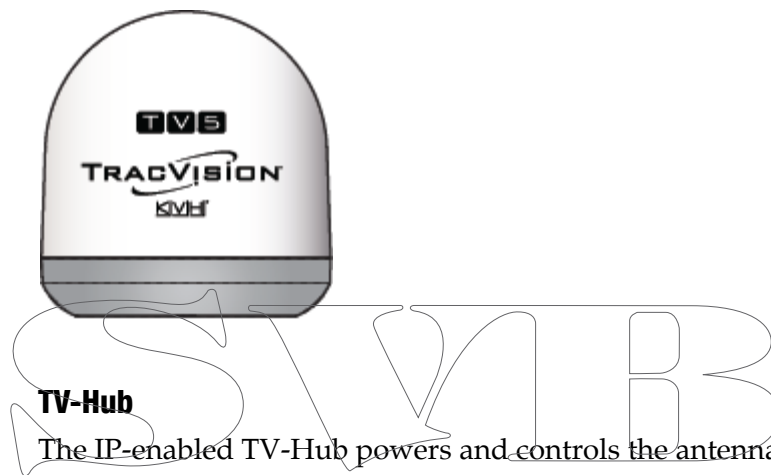

TV-Hub

The IP-enabled TV-Hub powers and controls the antenna. With its Ethernet connection and built-in Wi-Fi, you can access its easy-to-use web interface from any mobile device, allowing you to set up, operate, and monitor all aspects of the system. Its built-in library of over 100 satellites is fully customizable, and can even be updated over the Internet.

Figure 1-3 TV-Hub

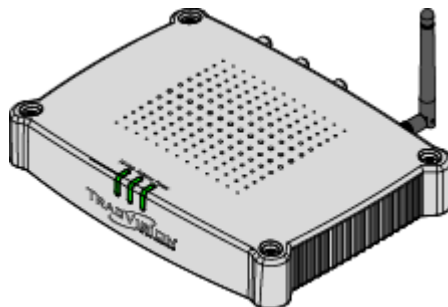

There are two versions of TV-Hub:

- **TV-Hub A:** Supplied with North American systems; includes a built-in DIRECTV SWM (single wire multiswitch) with its associated connectors on the rear panel; also supports DISH Network and Bell TV services
- **TV-Hub B:** Supplied with linear, DIRECTV Latin America, and Tri-Americas systems; does not include DIRECTV SWM components/connectors; identical to TV-Hub A otherwise, so it can also support DISH Network and Bell TV services

Figure 1-4 TV-Hub Versions

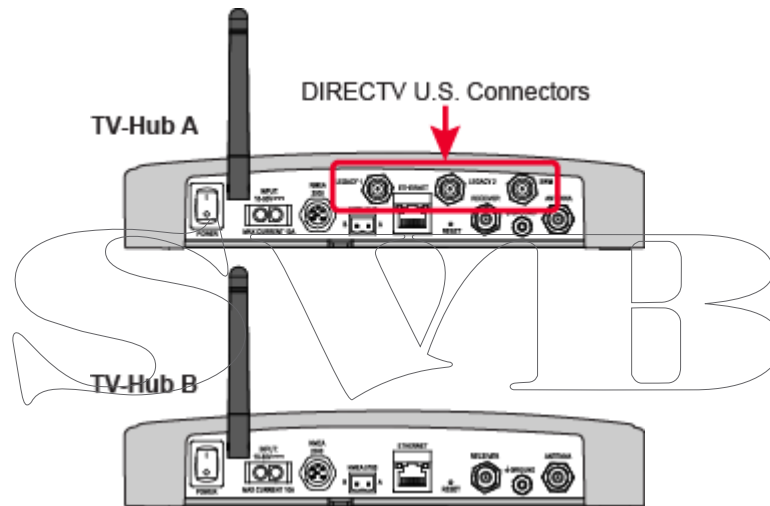



2. Getting Started

This section explains how to turn on the system for the first time and access the web interface.

Contents

Receiving Satellite TV Signals	11
Avoiding Blockage	12
Turning On the System	13
Accessing the Web Interface	14

SVIB

2

Receiving Satellite TV Signals

Television satellites are located in fixed positions above the Earth's equator and beam TV signals down to the earth within certain regions that they serve. Therefore, to receive TV signals from a given satellite, you must be located within that satellite's unique coverage area, also known as its "footprint." To view the latest TracVision satellite coverage maps, visit KVH's website at www.kvh.com/footprint.

Figure 2-1 Example of a Satellite Footprint

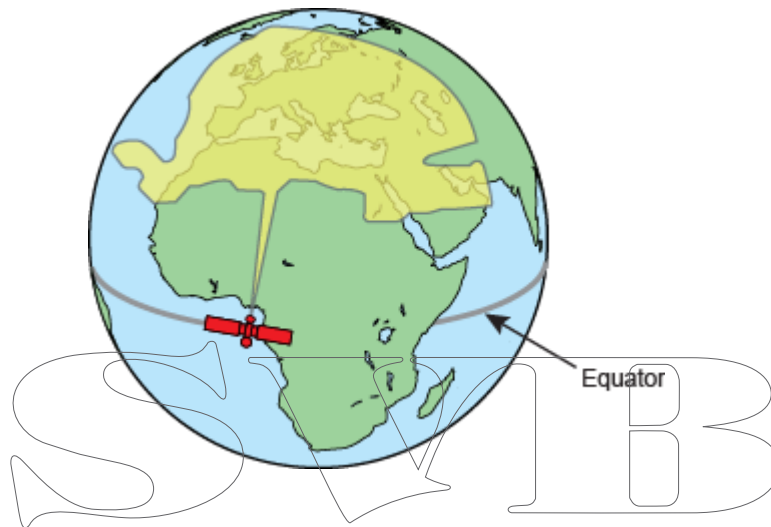

The size of the antenna makes a big difference in determining which satellites it can track and where. Larger antennas have the following advantages over smaller models:

- **Collects more signal:** As you move further away from the center of a satellite footprint, the power level, referred to as EIRP (effective isotropic radiated power), gradually fades, just like a radio station. Larger antennas can pull in more of the weak signal, so they can track a satellite at a lower EIRP than smaller antennas.
- **Narrower beamwidth:** Some satellites are very close together in the sky, separated by only a few degrees in longitude. Larger antennas receive signals within a narrower beam, reducing the chance of interference caused by transmissions from adjacent satellites.

Avoiding Blockage

Since satellites are located 22,300 miles (35,900 km) above the equator, the TracVision antenna must have a clear view of the sky to receive satellite TV signals. Anything that stands between the antenna and the satellite can block the signal, resulting in lost reception. Common causes of blockage include the following:

- Trees, buildings, and bridges
- Other vessels docked alongside your vessel
- Onboard masts, antennas, or other structures

Severe weather conditions or excessive dirt on the radome can also affect reception.

Figure 2-2 Example of Satellite Blockage



Turning On the System

To turn on your TracVision system, follow these steps:

1. Make sure the antenna has a clear, unobstructed view of the sky.
2. At the rear panel of the TV-Hub, set the power switch to the On (I) position. The TV-Hub supplies power to the antenna.

Figure 2-3 Power Switch (TV-Hub A shown)

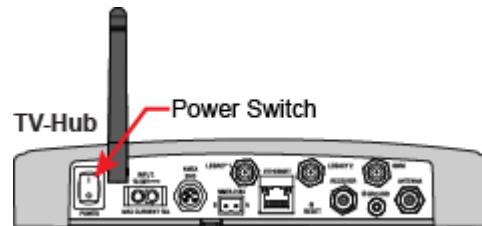

3. Wait a few minutes for system startup.

Important!

During startup, the TV-Hub checks the software versions installed in the antenna and updates them if necessary to match the versions it has stored for that model. All three status lights will alternate orange while this update is in progress. **Do not turn off the system during this time.** Updates might take up to 40 minutes.

4. Once the antenna finds the selected satellite, all three status lights on the TV-Hub should be lit green. If any lights are not lit green, refer to [“TV-Hub Status Indicators”](#) on page 87.

Figure 2-4 Status Lights

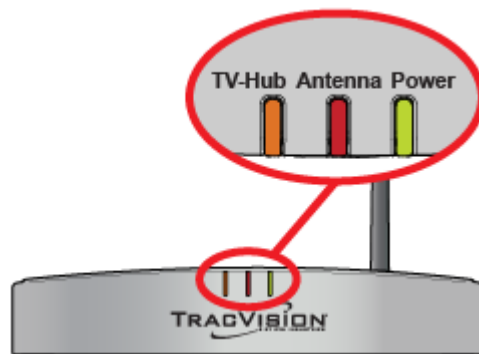

Accessing the Web Interface

The TV-Hub's web interface allows you to check system status, switch satellites and master receiver, update software and the satellite library, and configure all aspects of the system. To access the web interface using any Wi-Fi-enabled mobile device (such as a smartphone, tablet, or laptop), follow these steps:

1. Select the **TVHub-<TV-Hub serial number>** network from your device's Wi-Fi settings to connect to the TV-Hub.
2. Start your web browser and enter **http://tvhub.kvh**. As long as the TV-Hub is turned on and functioning properly, the Home page will appear in your browser. (If the web interface does not appear, try entering **http://172.16.0.1**, which is the default IP address of the TV-Hub.) For details on the information provided on the home page, see "[Status Information on the Home Page](#)" on page 85.

Figure 2-5 Wireless Connection to TV-Hub Web Interface

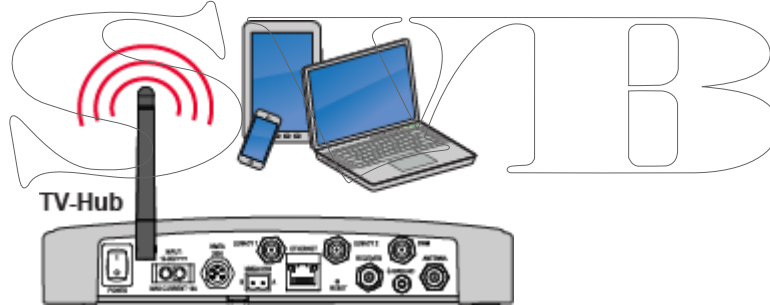

NOTE: If the TV-Hub is connected to an onboard network, you may also access the web interface over the network by entering the TV-Hub's IP address in your browser. (You can find the IP address on the Settings page of the web interface. See "[TV-Hub Ethernet Settings](#)" on page 19).



3. Network Settings

This section explains the various ways you can connect to the TV-Hub to access the web interface. It also explains how to connect the TV-Hub to an onboard network.

Contents

Connecting the TV-Hub to Your Onboard Network	17
TV-Hub Ethernet Settings	19
Connecting to the TV-Hub Using its Built-in Wi-Fi.....	20
TV-Hub Wireless Settings	21
Connecting Directly to the TV-Hub Ethernet Port	22
Resetting Network Settings to Factory Defaults.....	23

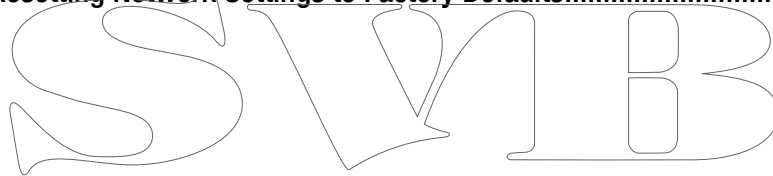

Connecting the TV-Hub to Your Onboard Network

You can connect the TV-Hub to an onboard local area network (LAN). A network connection is necessary if either of the following conditions apply:

- You have one or more IP AutoSwitches installed to enable automatic satellite switching (*Linear/DISH Network/Bell TV only*).
- You want to have the ability to access the TV-Hub's web interface using any device connected to your onboard network.

By default, the TV-Hub's Ethernet port is configured as a DHCP client, which means your network's router will automatically assign it an IP address. Simply connect the TV-Hub's Ethernet port to your onboard network then turn on the TV-Hub.

NOTE: Use a straight-through 100 Mbps fast Ethernet UTP CAT5 cable (or better) with RJ45 connectors.

Figure 3-1 TV-Hub Wired Network Connection (TV-Hub A shown)

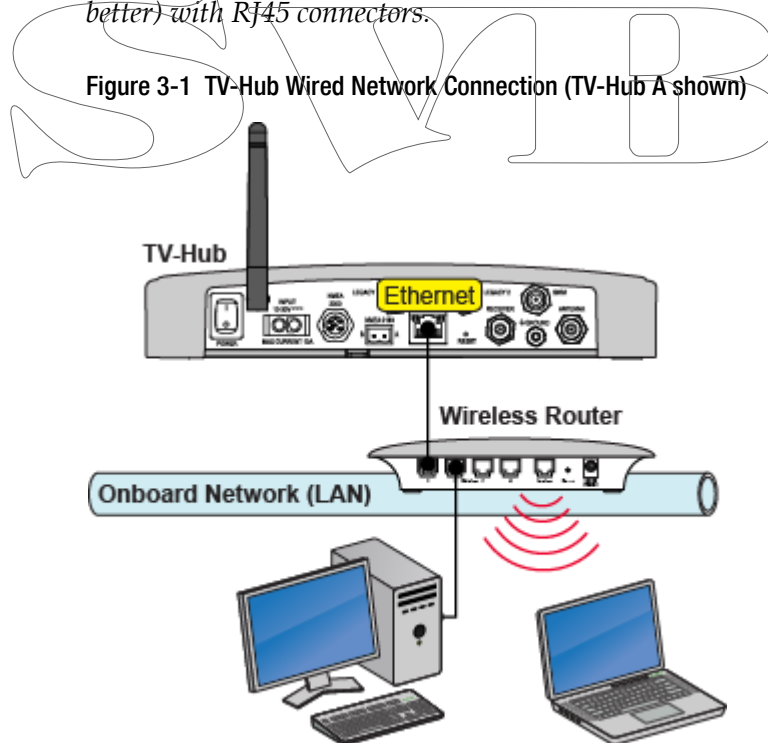

Once the TV-Hub is connected to your onboard network, you can access its web interface by entering the TV-Hub's dynamically assigned IP address in the web browser of any device connected to the network. You can find the TV-Hub's IP address on the web interface (select Settings > Network Settings).

If Bonjour is installed on your device, you can use it to find the TV-Hub on the onboard network without knowing the IP address. Just search for its host name: **TVHub-<TV-Hub serial number>**. For more information about Bonjour, visit www.apple.com/support/bonjour.

NOTE: In Dynamic (DHCP) mode, the TV-Hub could get assigned a different IP address whenever it is turned on. If you prefer, you can assign a static IP address to the TV-Hub that never changes, even after a reboot. See "TV-Hub Ethernet Settings" on page 19 for details.

Connecting the TV-Hub to Your Onboard Network Using its Built-in Wi-Fi

Although not recommended, you can modify the TV-Hub's wireless settings to connect to your onboard network using its Wi-Fi antenna, rather than using an Ethernet cable. However, once you change the TV-Hub's wireless settings from Access Point mode to Infrastructure mode, you will lose the ability to connect directly to the TV-Hub using your mobile device – you will always have to connect via the network. See "TV-Hub Wireless Settings" on page 21 for details.

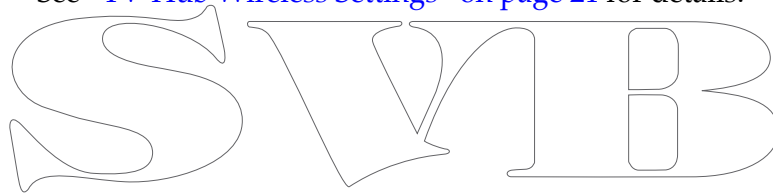

TV-Hub Ethernet Settings

By default, the Ethernet port of the TV-Hub is configured for **Dynamic** mode. This means that, when the TV-Hub is connected to an onboard network, the network's router assigns it an IP address. Most routers are normally configured as a DHCP (dynamic host configuration protocol) server.

NOTE: On startup, if the TV-Hub does not detect a DHCP server within a few seconds, it automatically assigns itself a static IP address: 169.254.253.1.

If you want to assign a specific IP address to the TV-Hub, you can configure the TV-Hub for **Static** mode at the Settings page of the web interface (go to Settings > Network Settings). When you select Static mode, you will need to enter the desired IP address, along with its associated subnet, gateway address, and broadcast address. These settings require networking expertise.

Important!

If your system is set up for automatic satellite switching for DIRECTV, make sure your DIRECTV receiver(s) have IP addresses in the same subnet as the TV-Hub. If your system includes IP AutoSwitches for automatic satellite switching, make sure they are all on the same local LAN segment as the TV-Hub.

Figure 3-2 Ethernet Settings

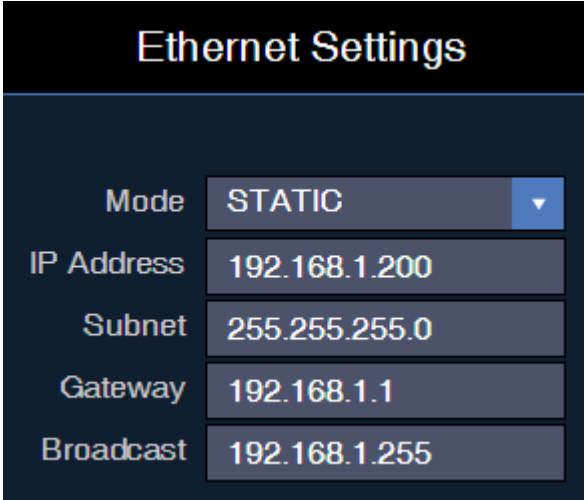

The screenshot shows the 'Ethernet Settings' page with the following configuration:

Ethernet Settings	
Mode	STATIC
IP Address	192.168.1.200
Subnet	255.255.255.0
Gateway	192.168.1.1
Broadcast	192.168.1.255

Connecting to the TV-Hub Using its Built-in Wi-Fi

You can connect any Wi-Fi enabled mobile device (such as a smartphone, tablet, or laptop) to the TV-Hub via its built-in wireless access point (WAP). The wireless range will depend on the layout and structure of the vessel. For example, wireless signals degrade when passing through bulkheads, water, and near metal masses.

Figure 3-3 TV-Hub Wi-Fi Connection (TV-Hub A shown)



NOTE: This direct wireless connection will not work if you changed the TV-Hub's wireless settings from Access Point mode to Infrastructure.

To access the TV-Hub's web interface via Wi-Fi, follow these steps:

1. Select the **TVHub-<TV-Hub serial number>** network from your device's Wi-Fi settings to connect to the TV-Hub.
2. Start your web browser and enter **http://tvhub.kvh**. (If the web interface does not appear, try entering **http://172.16.0.1**, which is the default IP address of the TV-Hub.)

TV-Hub Wireless Settings

By default, the TV-Hub's wireless settings are configured for the following:

- Wireless Mode: AP (Access Point)
- SSID: TVHub-<TV-Hub serial number>
- IP address: 172.16.0.1
- Security Mode: Off

You can change any of these settings at the Settings page of the web interface (go to Settings > Network Settings).

KVH strongly advises that you select the **WPA_PSK** security mode and assign a unique password to prevent unauthorized access. If you keep the default settings, you're allowing anyone to access the TV-Hub with their mobile device.

Important!

If you select Infrastructure (IF) mode to connect the TV-Hub to your onboard network, you will no longer be able to access the TV-Hub's web interface directly – you will have to go through the network. Therefore, KVH strongly recommends that you keep the TV-Hub set to Access Point (AP) wireless mode.

Figure 3-4 Wireless Settings with Security Applied

Wireless Settings	
Wireless Mode	AP (Access Point) ▼
SSID	TVHub-140311659
IP Address	172.16.0.1
Subnet	255.255.255.0
Gateway	172.16.0.1
Broadcast	172.16.0.1
Security Mode	WPA_PSK ▼
Password	240300659

Connecting Directly to the TV-Hub Ethernet Port

You can connect a computer directly to the “Ethernet” port on the back of the TV-Hub. This option allows you to access the TV-Hub web interface if you do not have a Wi-Fi-enabled device and you do not wish to connect the TV-Hub to an onboard network.

NOTE: Use a straight-through 100 Mbps fast Ethernet UTP CAT5 cable (or better) with RJ45 connectors.

Once you have connected your computer, enter **http://169.254.253.1** into your web browser to access the TV-Hub's web interface.

Figure 3-5 TV-Hub Direct Wired Connection (TV-Hub A shown)

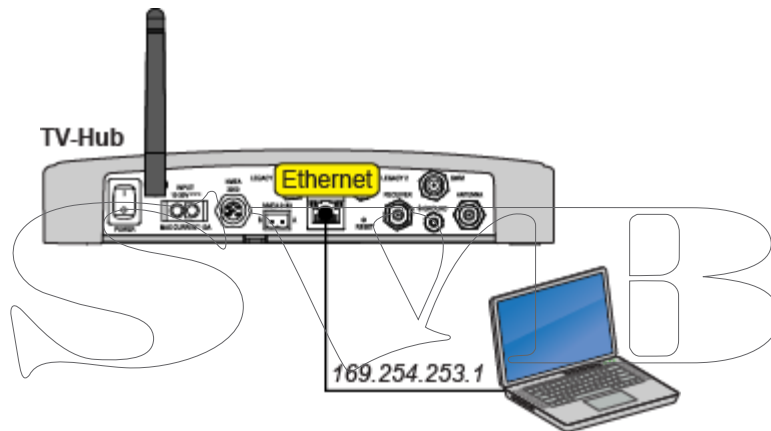

Resetting Network Settings to Factory Defaults

If the TV-Hub's network configuration becomes corrupted such that you can no longer access the web interface, you can reset all of the network settings to their original factory settings.

To reset the network settings to factory defaults, use a paper clip or pencil to press and hold the **Reset** button on the rear panel of the TV-Hub. Hold the button for about 5 seconds then release. The TV-Hub will reboot.

Important!

Resetting the system will turn off wireless security and clear your password. Be sure to reapply security settings to prevent unauthorized access. See ["TV-Hub Wireless Settings" on page 21](#) for details.

Figure 3-6 Reset Button (TV-Hub A shown)

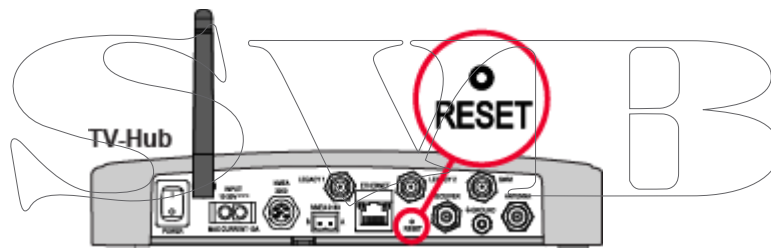



4. Antenna Settings

This section explains how to adjust the skew of a linear LNB, configure the antenna to use a NMEA input, and modify advanced settings.

Contents

Adjusting the LNB Skew Angle (Linear Only).....	27
Using the Optional NMEA Input.....	30
Advanced Settings.....	32

SVIB

4

Adjusting the LNB Skew Angle (Linear Only)

Unless your antenna is equipped with automatic skew, you need to manually adjust the LNB's skew angle to optimize signal reception whenever you change your geographic location or select a different satellite. (To learn more about skew, see ["Understanding Skew" on page 29.](#)) To set the skew angle, follow these steps:

1. Launch the Setup Wizard from the web interface (go to Settings > General Settings).
2. Unless the TracVision antenna is receiving position information from a NMEA device, manually enter your current position at the Setup Wizard.
3. At the Setup Wizard, note the displayed skew angle for the selected satellite.
4. Turn off the TV-Hub to remove power from the TracVision antenna.

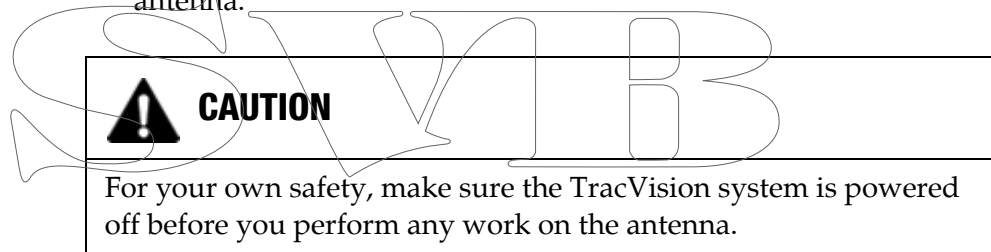

5. Remove the Phillips-head screws securing the radome to the antenna. Then carefully lift the radome straight up until clear of the antenna assembly and set it aside in a safe place.

NOTE: Do not place the radome on a hot metal surface – the heat may warp the radome.

Figure 4-1 Radome Removal

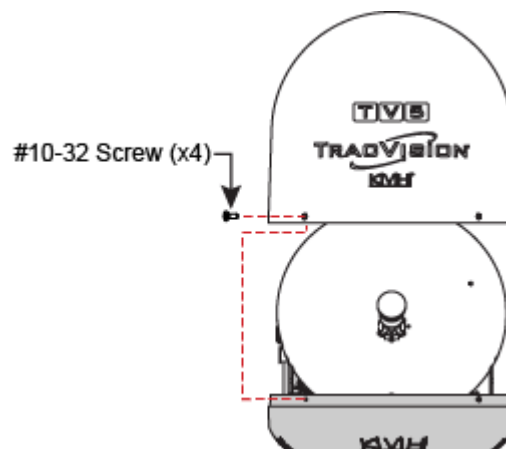

- Using a 2mm Allen hex key, loosen (but do not remove) the two M4 socket set screws securing the LNB to the reflector.

Figure 4-2 LNB Skew Adjustment

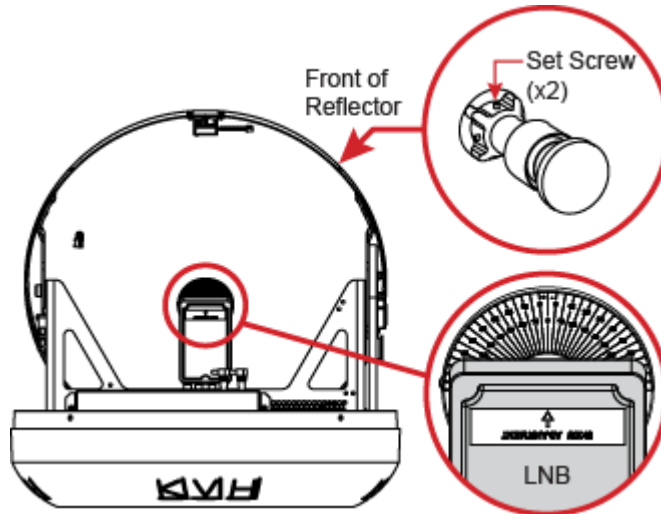

- Rotate the LNB clockwise or counter-clockwise until the arrow on the LNB points to the correct skew angle printed on the choke feed.

NOTE: Be sure to keep the LNB fully inserted into the choke feed to ensure optimum performance.

- Tighten the set screws to secure the LNB in place. Apply 11 in.-lbs (1.2 N-m) of torque, if possible.
- Reinstall the radome.

Understanding Skew

Linearly polarized satellite signals are transmitted in vertical and horizontal "waves" offset exactly 90° from each other. Since these signals are oriented in a precise cross pattern, the TracVision antenna's receiving element, called the LNB, must be oriented in the same way. This orientation is referred to as the LNB's "skew angle." The more precise the LNB's skew, the more signal it will collect and the better the reception.

Figure 4-3 How Skew Works

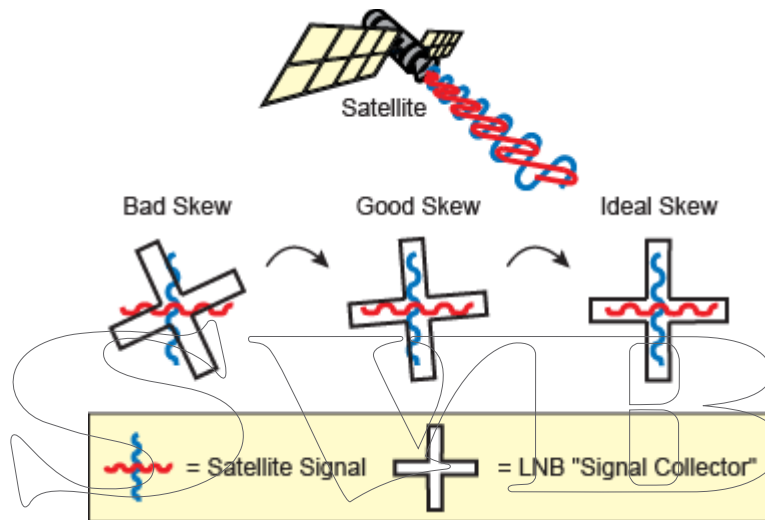

Using the Optional NMEA Input

If a NMEA device is connected to the TV-Hub, the antenna can use its GNSS position and heading data to speed up satellite acquisition. (Refer to the Installation Guide for details on connecting the NMEA device.) The current position and heading will also be displayed on the Home page of the web interface.

If the antenna is equipped with a built-in GPS, it will use the NMEA device as a backup source of position data. The Home page will display position data from the built-in GPS unless it switches to the NMEA backup.

Figure 4-4 TV-Hub NMEA Connections (TV-Hub A shown)

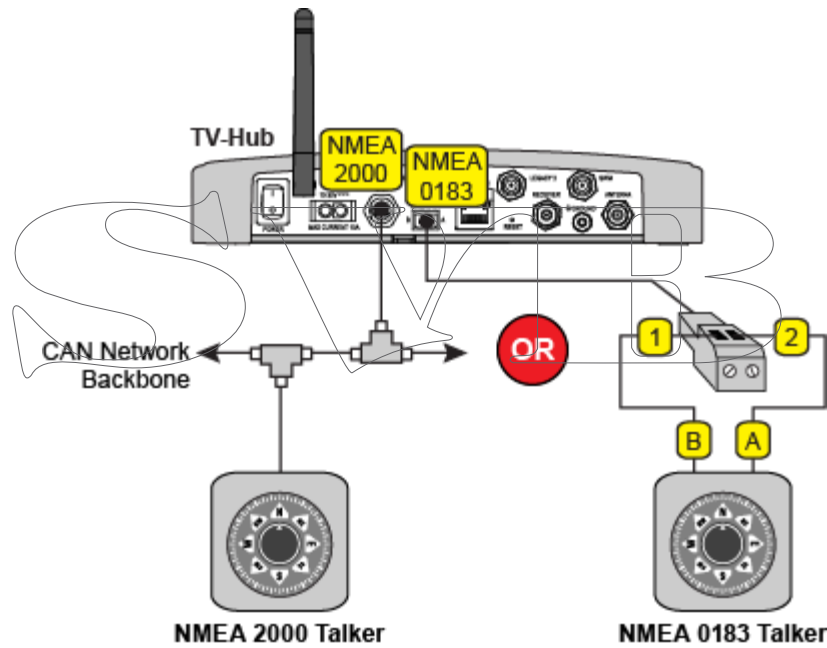

NOTE: TV-Hubs built after August 2014 are equipped with the NMEA 2000 connector.

To configure the system to use data from a connected NMEA device, follow these steps:

1. To use a **NMEA 0183** device, configure it to transmit one or more of the following messages at 4800 baud:

\$--xxx Message	Description
HDG	Heading, Deviation and Variation
HDM	Heading, Magnetic
HDT	Heading, True
OSD	Own Ship Data
THS	True Heading and Status
VHW	Water Speed and Heading
RMC	GNSS Position Data

To use a **NMEA 2000** device, configure it to transmit one or more of the following messages via the CAN network:

PGN	Description
127250	Vessel Heading
129029	GNSS Position Data

2. Select the NMEA source at the TracVision Setup Wizard. You can launch the Setup Wizard from the web interface (go to Settings > General Settings).

Advanced Settings

The following advanced settings enhance the performance of the TracVision antenna system:

- Sleep Mode (see [“Sleep Mode” on page 32](#))
- Band/Polarization Control (see [“Band/Polarization Control” on page 32](#))
- Sidelobe Mode (see [“Sidelobe Mode” on page 33](#))

Although the factory default settings work well in most cases, you can change any of them at the web interface (go to Settings > Advanced Settings).

Sleep Mode

When you are moving, the antenna's motors need to run continuously to keep the antenna pointed at the satellite and locked onto the peak signal. However, if you are stationary, the motors don't need to run since the antenna's orientation to the satellite doesn't change. In these stationary conditions, Sleep mode locks the antenna in place and shuts down the motors to conserve power and silence the antenna.

KVH recommends that you keep Sleep mode set to **On** (default setting).

Band/Polarization Control

Linear satellite TV channels can be carried on any of a satellite's four combinations of frequency band and polarization. Since only one of these four signals can be delivered to a receiver at any one time, the receiver sends a voltage/ tone on its coax cable to request the band/ polarization for the currently selected channel:

Voltage	Tone	Polarization	Band
13 VDC	Off	Vertical	Low
18 VDC	Off	Horizontal	Low
13 VDC	On	Vertical	High
18 VDC	On	Horizontal	High

With Band/Polarization Control set to **Master Receiver** (default setting), the satellite signal output of the TV-Hub's "Receiver" port is the polarization and band that is currently selected by the master receiver. This setting is recommended for most configurations and ensures the antenna always receives a valid band/polarization on which to track the satellite.

If you have a linear configuration with a multiswitch and one or more IP AutoSwitches installed, KVH recommends that you set Band/Polarization Control to **TV-Hub**. In this configuration, the TV-Hub ignores the voltage/tone from the master receiver and outputs whichever polarization/band corresponds to the voltage/tone that is present on the coax cable connected to its "Receiver" port. This allows the multiswitch to continue receiving all four combinations of band/polarization from the antenna.

Figure 4-5 Example of Conflicting Band/Polarization Requests

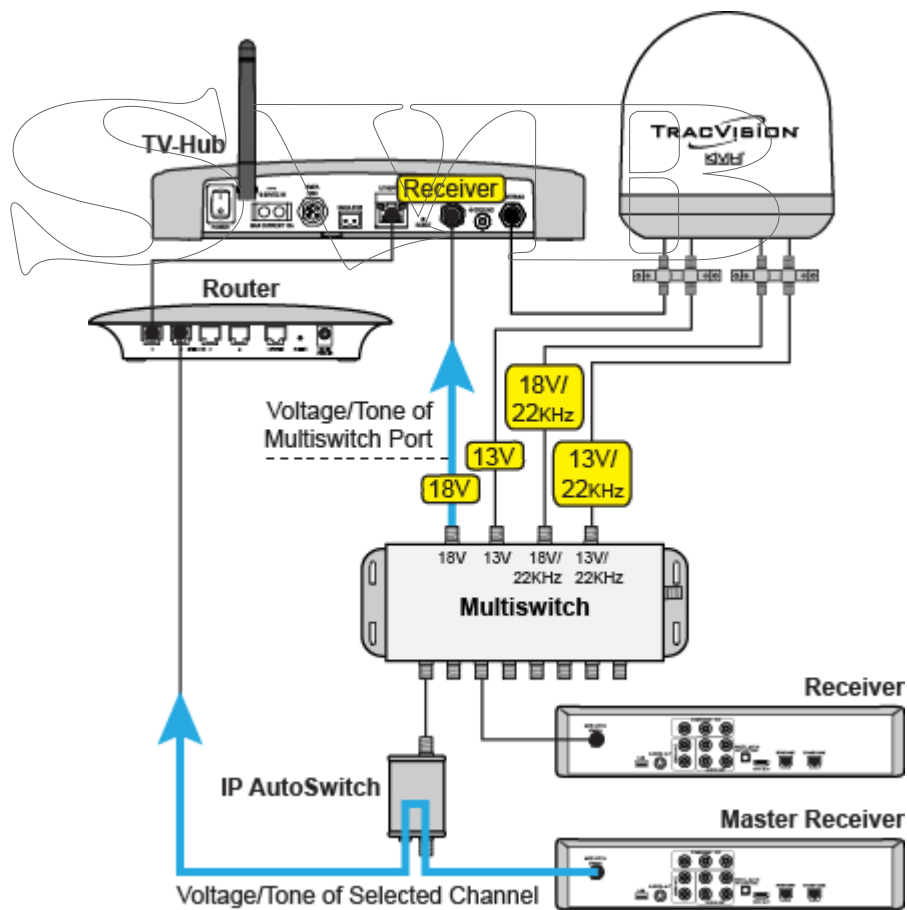

Sidelobe Mode

This mode only applies to the TracVision TV6 model.



5. Receiver Settings

This section explains how to set up various types of satellite TV receivers to operate with the TracVision system. For receiver wiring details, refer to the Installation Guide.

Contents

Configuring a Linear Receiver for Automatic Switching.....	37
Configuring DIRECTV Receivers for Automatic Switching	38
Allowing External Access on a DIRECTV Receiver	42
Setting the Dish Type on a DIRECTV Receiver	43
Running a Check Switch Test on a DISH Network or Bell TV Receiver.....	45
Activating Your Receiver(s).....	49

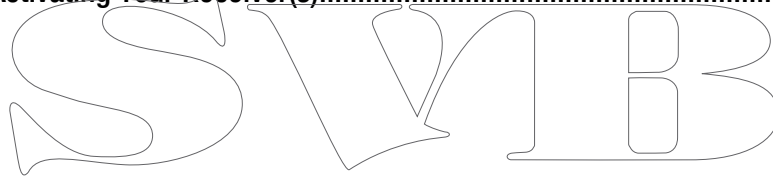

Configuring a Linear Receiver for Automatic Switching

For automatic satellite switching to work properly using the DiSEqC communication protocol, you need to set up your receivers for the same satellites you installed in the TracVision antenna. Be sure to set up the satellites in the receiver in the exact same order as they were set up in the antenna. The specific setup process varies among receiver models – refer to your receiver owner's manual for details. Use the table and figure below as a guide.

Satellites in Antenna	Matching Satellites in Receiver
Slot A	Port/Switch/LNB/DiSEqC 1 or A
Slot B	Port/Switch/LNB/DiSEqC 2 or B
Slot C	Port/Switch/LNB/DiSEqC 3 or C
Slot D	Port/Switch/LNB/DiSEqC 4 or D

Figure 5-1 Linear Receiver DiSEqC Settings (Example)

The figure shows the TV-Hub Web Interface configuration for a linear receiver. It is divided into two main sections: 'TV-Hub Web Interface' and 'Receiver Setup'.

TV-Hub Web Interface: Shows a 'Satellite Group Name' 'MyEuropeGroup' and four slots (A, B, C, D) with their respective satellite names: Slot A: Hotbird 6,7,8 Europe - 13E; Slot B: Astra 1 - 19E; Slot C: Astra 4A - 5E; Slot D: Eutelsat W3A - 7E.

Receiver Setup: Shows four individual satellite configuration panels, each with the following settings:

- Ku_HOTBIRD 6,7A,8:** LNB Type: 09750/10600, LNB Power: 13/18V, 22KHz: Auto, Toneburst: None, DiSEqC1.0: LNB1, DiSEqC1.1: None, Motor: None.
- Ku_ASTRA 1H,1KR,1L,1M:** LNB Type: 09750/10600, LNB Power: 13/18V, 22KHz: Auto, Toneburst: None, DiSEqC1.0: LNB2, DiSEqC1.1: None, Motor: None.
- Ku_ASTRA 4A:** LNB Type: 09750/10600, LNB Power: 13/18V, 22KHz: Auto, Toneburst: None, DiSEqC1.0: LNB3, DiSEqC1.1: None, Motor: None.
- Ku_Eutelsat 7E:** LNB Type: 09750/10600, LNB Power: 13/18V, 22KHz: Auto, Toneburst: None, DiSEqC1.0: LNB4, DiSEqC1.1: None, Motor: None.

Configuring DIRECTV Receivers for Automatic Switching

To establish communications between the TracVision system and each SWM-compatible DIRECTV receiver for automatic satellite switching, you need to set each receiver to a static IP address and enter that address, along with the receiver's location, in the TV-Hub's web interface. (For details on connecting DIRECTV receivers to the TracVision system for automatic switching, see ["Automatic Satellite Switching for DIRECTV"](#) on page 69.)

Static IP Address Range WITHOUT an Onboard Network

If the DECA Broadband Kit or the Genie DVR is connected directly to the TV-Hub's Ethernet port (no router is installed), set each receiver's IP address to any address ranging from 192.168.x.2 to 192.168.x.149, where x=1<the last 2 digits in the TV-Hub's serial number>.

For example, if the serial number of the TV-Hub is 140901484, you might assign an IP address of 192.168.184.2. Refer to the instructions in ["Assigning a Static IP Address to a DIRECTV Receiver"](#) on page 40. The TV-Hub has a hidden IP address of 192.168.x.1 reserved for automatic switching communications. This IP address is not shown on the Network Settings page of the web interface.

Figure 5-2 IP Addressing for Automatic Switching (Example)

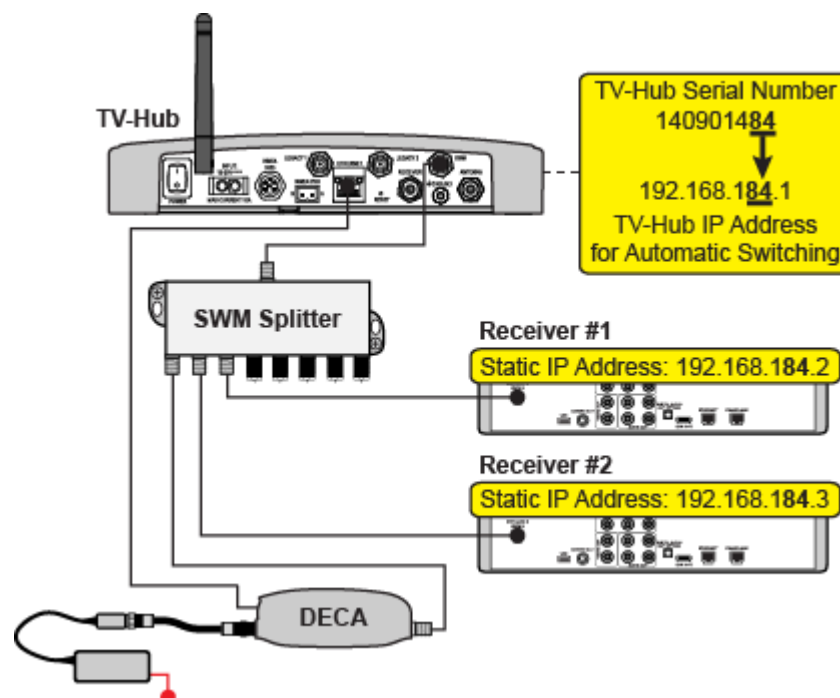

Static IP Address Range WITH an Onboard Network

If the TV-Hub and the DECA Broadband Kit or Genie DVR are connected to an onboard network (i.e., router), set each receiver to a static IP address that is outside the router's DHCP range. (Refer to your router's user manual for details on finding its IP address range.) For example, if the router has an IP address of 192.168.1.1 and assigns IP addresses ranging from 192.168.1.100 to 192.168.1.149 via DHCP, you could set each receiver's IP address to any address ranging from 192.168.1.150 to 192.168.1.254. Refer to the instructions in [“Assigning a Static IP Address to a DIRECTV Receiver”](#) on page 40.

Figure 5-3 Router DHCP Settings (Example)

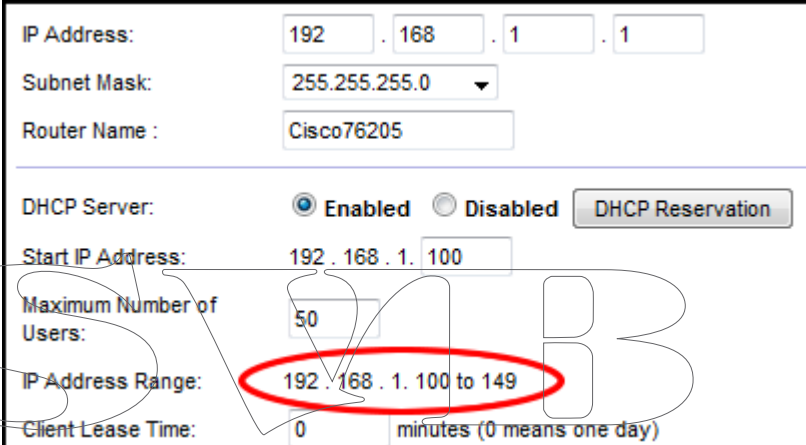

The screenshot displays the DHCP settings for a router. The IP Address is set to 192.168.1.1, Subnet Mask to 255.255.255.0, and Router Name to Cisco76205. The DHCP Server is enabled. The Start IP Address is 192.168.1.100, Maximum Number of Users is 50, and Client Lease Time is 0 minutes. The IP Address Range is 192.168.1.100 to 149, which is circled in red. A large watermark 'SMB' is overlaid on the image.

IP Address:	192	.	168	.	1	.	1
Subnet Mask:	255.255.255.0						
Router Name :	Cisco76205						
DHCP Server:	<input checked="" type="radio"/> Enabled		<input type="radio"/> Disabled		DHCP Reservation		
Start IP Address:	192 . 168 . 1 . 100						
Maximum Number of Users:	50						
IP Address Range:	192 . 168 . 1 . 100 to 149						
Client Lease Time:	0		minutes (0 means one day)				

Assigning a Static IP Address to a DIRECTV Receiver

Once you have identified a valid static IP address range for your receivers, follow these steps to assign a unique static IP address within that range to each receiver.

NOTE: These steps may vary, depending on your receiver's model and software version. Refer to your receiver's owner's manual for details.

NOTE: A video tutorial showing how to navigate to the receiver's IP address is available in [KVH's TracVision Tutorials playlist on YouTube](#) (Internet access required).

1. Activate the receiver for DIRECTV service, if you haven't already done so (see "[Activating Your Receiver\(s\)](#)" on [page 49](#)). The receiver must be activated before you can access the required menus.
2. Press **MENU** on the receiver's remote control to access the onscreen menu.
3. At the main menu, highlight **Settings & Help**. Then select **Settings**.
4. Highlight and select **Network Setup**.
5. Select **Advanced Setup**.
6. Change the IP address to the new static IP address. (On a Genie DVR, the IP address is called the "Server IP"). All of the other fields can be left as is.
7. Highlight and select **Connect Now** to save your changes. Disregard any error messages about missing Internet connectivity. Note this receiver's IP address and location onboard for future reference.
8. Repeat this procedure for each additional receiver. Be careful not to use the same IP address twice.

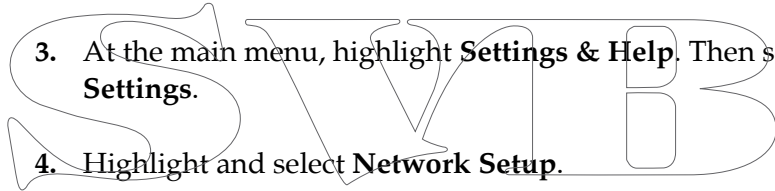
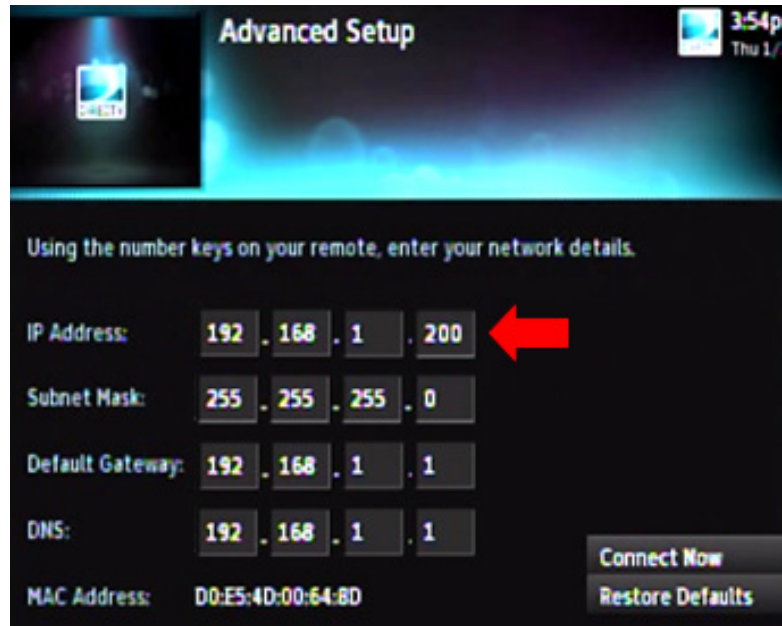

Figure 5-4 IP Address on a DIRECTV Receiver (Example)



SVIB

Allowing External Access on a DIRECTV Receiver

For automatic satellite switching, the TV-Hub needs to communicate with the receiver over the network. The receiver needs to be set up to allow this external access. To allow external access on a DIRECTV receiver, follow these steps:

NOTE: A video tutorial of this procedure is available in [KVH's TracVision Tutorials playlist on YouTube](#) (Internet access required).

1. Press **MENU** on the receiver's remote control to access the onscreen menu.
2. At the main menu, highlight **Settings & Help**. Then select **Settings**.
3. Highlight and select **Whole-Home**
4. Highlight and select **External Device**.
5. Set External Access to **Allow**.
6. At the warning message, select **OK**.

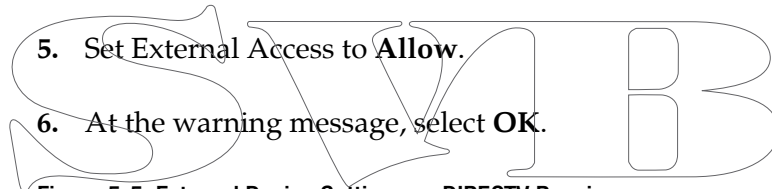
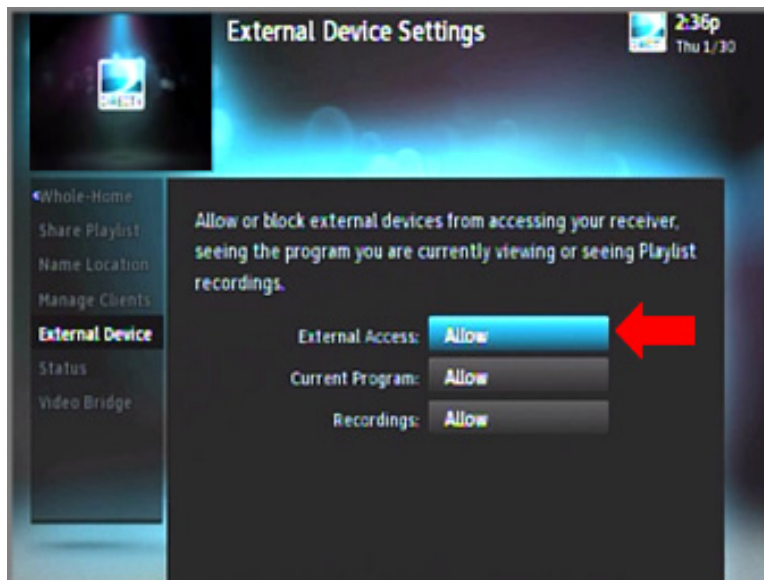

Figure 5-5 External Device Settings on DIRECTV Receiver



Setting the Dish Type on a DIRECTV Receiver

To work with the TracVision system, the DIRECTV receiver(s) must be set to the correct dish type for your particular configuration. To set the dish type, follow these steps:

NOTE: A video tutorial of this procedure is available in [KVH's TracVision Tutorials playlist on YouTube](#) (Internet access required).

1. Press **MENU** on the receiver's remote control to access the onscreen menu.
2. At the main menu, highlight **Settings & Help**. Then select **Settings**.
3. Highlight and select **Satellite**.
4. Highlight and select **Repeat Satellite Setup**.
5. At the warning message, press the **Dash (-)** button on the receiver's remote control.
6. Set the appropriate dish type for your receiver:

Receiver Type	Dish Type	Switch Type
U.S. SWM	3-LNB	SWM
U.S. Non-SWM and Latin America	Round	Multiswitch

7. Highlight and select **Continue** to save your changes.

Figure 5-6 Satellite Dish Setup on DIRECTV Receiver



SWM

Running a Check Switch Test on a DISH Network or Bell TV Receiver

To operate with the TracVision system, you need to run a single Check Switch test on every DISH Network or Bell TV receiver. To run a Check Switch test, follow these steps:

NOTE: A video tutorial of this procedure is available in [KVH's TracVision Tutorials playlist on YouTube](#) (Internet access required).

1. Make sure the vessel is docked in calm water in a blockage-free area. The antenna must have an unobstructed view of the sky.

Important!

The antenna must remain motionless throughout this procedure.

2. Connect the receiver directly to the "Receiver" port on the back of the TV-Hub. You must run the Check Switch test on each receiver, one at a time, while it is connected directly to the TV-Hub via a single RF coax cable.

3. Turn on the TracVision system and connect to the web interface (see "[Accessing the Web Interface](#)" on page 14). Proceed through the steps of the Setup Wizard until it prompts you to run the Check Switch test. If the Setup Wizard does not display automatically, you can launch the Setup Wizard from the web interface (go to Settings > General Settings).

4. Connect a TV to the receiver so you can view the receiver's onscreen menu.

NOTE: The setup process may differ depending on service provider and receiver model. Refer to your receiver owner's manual for details.

5. At the Program Remote to Receiver screen, press **SAT** then **RECORD** on the receiver's remote to begin the setup process.

Important!

If the Program Remote to Receiver screen does not appear, or the screen shows "Acquiring Signal" instead, go directly to the Point Dish screen by pressing **MENU, 6, 1, 1** on the receiver's remote. Then perform steps 11 and 12 of this procedure to run a Check Switch test. *In the case of the "Acquiring Signal" screen, you need to press MENU, 6, 1, 1 while that screen is displayed. Otherwise, you will need to reset the receiver and try again.*

6. When the number for your remote control appears on the screen, select **Continue**.
7. Wait while the receiver downloads the latest software. This update may take up to 20 minutes.
8. At the Set Video Resolution screen, select the highest video resolution that is supported by your TV. Then run the resolution test and save your setting.
9. Allow the receiver to run two tests of its landline connections (Ethernet and phone). It probably won't detect any, since the receiver is installed in a mobile environment.
10. At the Activate Receiver screen, press **STAR (*)** on the receiver's remote.
11. At the Setup Details screen, select **Point Dish**. Then select **Check Switch**. The receiver now runs the Check Switch test.
12. At the Installation Summary screen, make sure all of the satellites you installed in the TracVision antenna are listed "OK." Also be sure the switch type is "DP34." If you do not see these results, select **Test** to run another test. Otherwise, select **Done**.

Figure 5-7 Check Switch Test Results



13. At the Point Dish screen, select **Done**.

14. At the Setup Details screen, select **Continue**.
15. Allow the receiver to run two additional tests of its landline connections.
16. At this point, you may activate the receiver. Call the number provided in ["Activating Your Receiver\(s\)" on page 49](#). Once the receiver is activated, the process is complete.
17. Repeat this procedure for any additional receivers, making sure you connect each receiver directly to the TV-Hub as directed in step 2. When you are done, reconnect all system components as necessary for your chosen configuration.
18. When you are done running Check Switch tests, proceed to the next page of the Setup Wizard. Do not close your web browser window to exit.

Important!

If you accidentally close your web browser window instead of proceeding to the next page of the Setup Wizard, be sure to set the Check Switch mode to **Off** at the General Settings page of the web interface. See ["Check Switch Mode" on page 48](#) for details.

Check Switch Mode

When the Setup Wizard prompts you to run a Check Switch test for a DISH Network or Bell TV configuration, the antenna automatically enables Check Switch mode. In this mode, the antenna stops actively tracking and stores the relative pointing position to each installed satellite. Satellite switching is nearly instantaneous - the antenna just shifts to the stored pointing positions. This rapid switching allows a Check Switch test to pass on its first attempt. (The receiver assumes it is connected to a stationary home antenna with multiple LNBS, so it expects all satellites to be available at once.)

Important!

While in Check Switch mode, the antenna must remain motionless. Since the antenna is not tracking the satellite in this mode, any movement will throw off the relative pointing positions.

Keep the Check Switch mode set to **Off** (default setting) for normal operation. Check Switch mode should only be set to **On** when you need to run a Check Switch test on a receiver. You can change the current Check Switch mode setting at the web interface (go to Settings > General Settings).



Activating Your Receiver(s)

Before you can watch television, the receiver(s) must be activated for your satellite TV service. Refer to the receiver owner's manual or packaging for details.

To activate DIRECTV U.S. or DISH Network receivers, call the following:

To activate:	Call:
DIRECTV U.S.	+1 866 551-8004
DISH Network	+1 800 970-9829

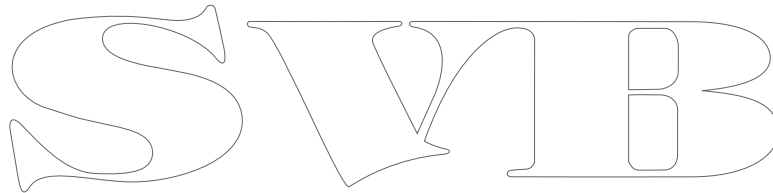



6. Satellite Settings

This section explains how to select, edit, and add satellites and satellite groups.

Contents

Selecting a Single Satellite.....	53
Creating a New Satellite.....	54
Selecting a Satellite Group	55
Creating a New Satellite Group	57
Changing Satellites in a Group	59
Changing Satellite Tracking Parameters	60

SVIB

6

Selecting a Single Satellite

If all of the programming you want to watch is carried by a single satellite, follow these steps to configure the antenna to track that one satellite:

Important!

KVH recommends that you run the Setup Wizard whenever you need to change the configuration of your system (especially if you need to change your satellite TV service or receiver equipment). The Wizard will guide you through all of the necessary configuration steps, including satellite selection. You can launch the Setup Wizard from the web interface (go to Settings > General Settings).

1. On the Satellites page of the web interface, set Satellite Mode to **Single**.
2. All satellites that are compatible with your antenna and its currently installed LNB are displayed in a list. Choose a region to filter the list for your location (e.g., Europe). You can also order the list by name, orbital slot, or region by clicking the associated header.
3. Find the desired satellite and select **Installed**. The antenna will start searching for the selected satellite.

NOTE: If the satellite you want to track is missing, you can add it to the list. See "Creating a New Satellite" on page 54 for details.

Figure 6-1 Single Satellite Mode

Installer	Name	Orbital Slot	Region	Favorites
<input type="radio"/>	AM1 Europe Wide-beam	40E	Europe	<input type="checkbox"/>
<input type="radio"/>	Amos 2	4W	Europe	<input type="checkbox"/>
<input type="radio"/>	Astra 1	19E	Europe	<input type="checkbox"/>
<input type="radio"/>	Astra 2 North	28E	Europe	<input type="checkbox"/>
<input type="radio"/>	Astra 2 South	28E	Europe	<input type="checkbox"/>
<input type="radio"/>	Astra 3A	24E	Europe	<input type="checkbox"/>
<input type="radio"/>	AtlanticBird 3	5W	Europe	<input type="checkbox"/>
<input checked="" type="radio"/>	Badr-3,4	26E	Europe	<input checked="" type="checkbox"/>
<input type="radio"/>	Eutelsat	36E	Europe	<input type="checkbox"/>

Creating a New Satellite

If the satellite you wish to track is not included in the satellite library, you can add a new custom “User” satellite. To create a new satellite, follow these steps:

1. On the Satellites page of the web interface, click the (i) information icon next to any of the “User” satellites.
2. Fill in all of the tracking parameters with the correct information for your desired satellite. See [“Changing Satellite Tracking Parameters”](#) on page 60.

NOTE: You can only create a satellite that is compatible with the LNB that is currently installed in the antenna.

3. Choose a friendly name for your new satellite, so that you can easily identify it later. Then save your changes.
4. To install your new satellite in the antenna for tracking, follow the steps in [“Selecting a Single Satellite”](#) on page 53.

Figure 6-2 User Satellites (Circular)

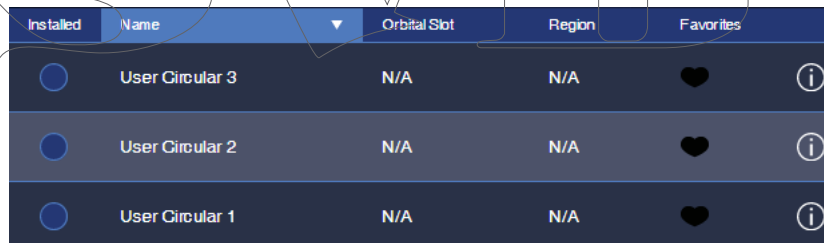

Installed	Name	Orbital Slot	Region	Favorites
<input type="radio"/>	User Circular 3	N/A	N/A	<input type="checkbox"/> (i)
<input type="radio"/>	User Circular 2	N/A	N/A	<input type="checkbox"/> (i)
<input type="radio"/>	User Circular 1	N/A	N/A	<input type="checkbox"/> (i)

Selecting a Satellite Group

The TV-Hub comes preloaded with some of the most popular groups of satellites. To select one of these preset groups for tracking, or to select a custom group that you created yourself, follow these steps:

Important!

KVH recommends that you run the Setup Wizard whenever you need to change the configuration of your system (especially if you need to change your satellite TV service or receiver equipment). The Wizard will guide you through all of the necessary configuration steps, including satellite selection. You can launch the Setup Wizard from the web interface (go to Settings > General Settings).

1. On the Satellites page of the web interface, set Satellite Mode to **Group**.

Figure 6-3 Preset Satellite Groups (Example)

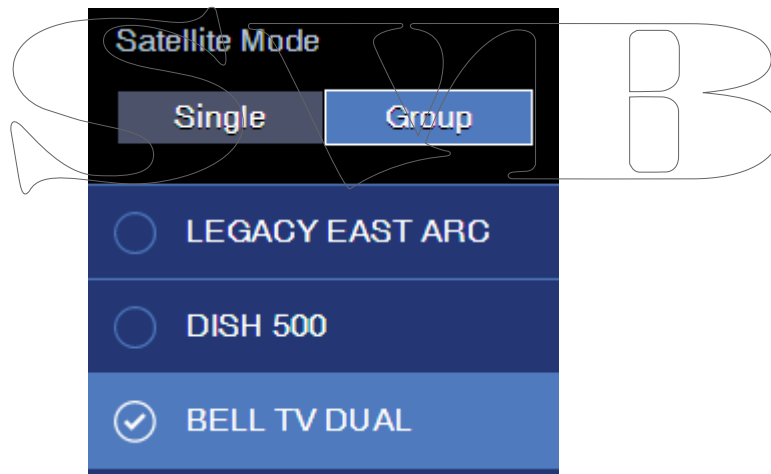

2. Choose a satellite group from the list. (This list will vary depending on your system's configuration.) All preset groups are listed below.

Linear Groups

Preset Satellite Groups (A-B-C-D)	Compatible Antennas
Europe 1: Hotbird – Astra1 – Astra2S – Astra3	TV5, TV6*
Europe 2: Astra3 – Astra1 – Hotbird – Astra2S	TV5, TV6*
Scandinavia: Astra4 – Thor – Hotbird – Astra1	TV5, TV6*
<i>* Automatic skew required.</i>	

DIRECTV Groups

Preset Satellite Groups	Compatible Antennas
DIRECTV Dual: 101W – 119W	All
Tri-Am TriSat: 101W – 119W – 95W	TV5, TV6*
Tri-Am Dual: 101W – 95W	TV5, TV6*
<i>* Tri-Americas LNB required (DIRECTV U.S. + Latin America).</i>	

DISH Network Groups

Preset Satellite Groups	Compatible Antennas
Eastern Arc: 61W – 72W – 77W	TV3, TV5, TV6*
Western Arc: 110W – 119W – 129W	All*
Legacy East Arc: 61W – 110W – 119W	All
DISH 500: 110W – 119W	All
72W: 72W only	TV3, TV5, TV6*
<i>* TV1/RV1 is not compatible with the Eastern Arc or 72W at this time. In addition, due to the low elevation angle, the 129W satellite cannot be viewed by the TV1/RV1 in the Northeast U.S.</i>	

Bell TV Group

Preset Satellite Group	Compatible Antennas
Bell TV Dual: 82W – 91W	TV3, TV5, TV6*
<i>* TV1/RV1 is limited to the 91W satellite at this time.</i>	

Creating a New Satellite Group

If there is no preset satellite group containing the satellites you want to track, you can create your own custom satellite group. Follow these steps:

1. On the Satellites page of the web interface, set Satellite Mode to **Group**.
2. Select **Create New Group**.
3. Choose up to four satellites from the satellite library to include in your new satellite group.

Important!

When adding linear satellites to a group, be sure to consider the skew angle for each satellite if the antenna is not equipped with automatic skew. In general, if the satellites are greater than 10° apart in longitude, you will not be able to set the LNB at a skew angle that works for all of them. You might need to adjust the skew whenever you switch satellites.

4. Choose a friendly name for your group, so that you can easily identify it later. Then save your changes.
5. To install the new satellite group in the antenna for tracking, follow the steps in ["Selecting a Satellite Group" on page 55](#).

NOTE: If you assign your new group the same name as an existing user-defined group, the new group will overwrite the older one. You cannot use any of the names that are reserved for preset groups.

Figure 6-4 Creating a New Satellite Group

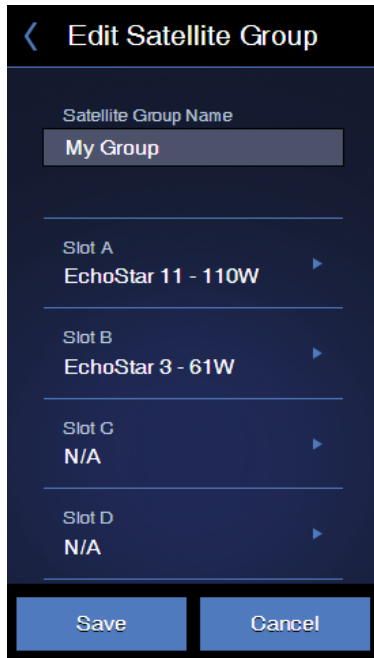

SVIB

Changing Satellites in a Group

While you cannot alter the satellites in a preset group, you can change the satellites that are included in any user-defined group. Follow these steps to edit a user-defined group:

1. On the Satellites page of the web interface, set Satellite Mode to **Group**.
2. Select the group you want to modify, then select **Edit Group**.
3. Change any of the four satellites you want to replace. Then save your changes.

Figure 6-5 Editing a Satellite Group

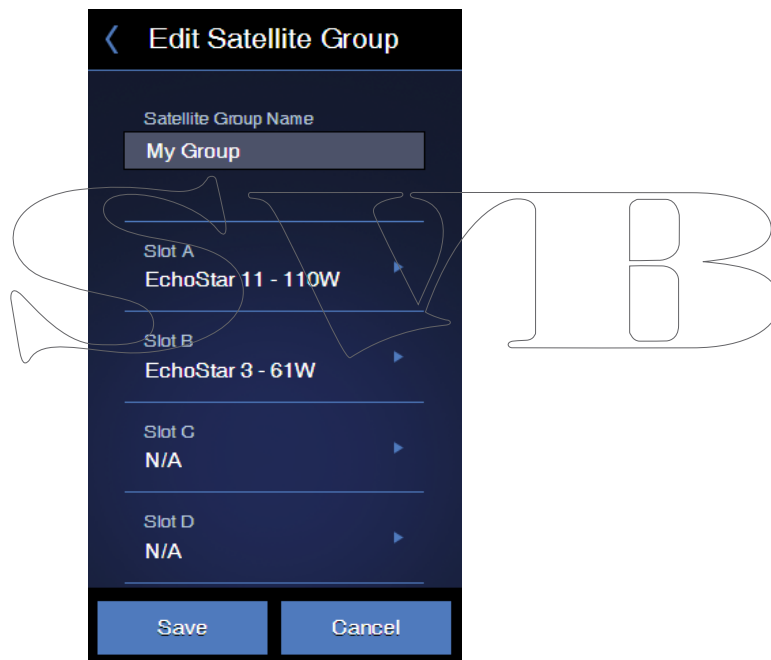

Changing Satellite Tracking Parameters

A satellite TV service provider may change a transponder frequency or other satellite parameters at any time without warning. Since the antenna uses these parameters to identify and track the satellite, the TV-Hub allows you to change the tracking parameters of any satellite in its library.

NOTE: KVH regularly updates the satellite library for service provider changes. You can download the latest update from the TV-Hub web interface. See "Updating the Satellite Library" on page 104 for details. Your local KVH dealer or distributor will be informed whenever an update is required.

NOTE: You can find satellite information on the web at www.lyngsat.com (not affiliated with KVH).

To manually edit the tracking parameters of a satellite, follow these steps:

1. On the Satellites page of the web interface, click the (i) information icon next to the affected satellite.
2. Make the necessary changes to the tracking parameters. Then save your changes.

Be sure to set the parameters for each polarization/band. Linear satellites use four combinations of polarization/band: Horizontal Low, Horizontal High, Vertical Low, and Vertical High. Circular satellites use two polarizations in a single band: Right and Left.

Editable tracking parameters for any satellite are listed below.

Parameter	Description
Frequency	00000 MHz or 10700 MHz-12750 MHz
Symbol Rate	1000-45000 (33000 max if DVB-S2)
FEC Code	1/2, 2/3, 3/4, 3/5, 4/5, 5/6, 5/11, 6/7, 7/8, 8/9, 9/9, or 9/10
Satellite ID	Hexadecimal (0x#####)
Decoder Type	QDSS: Legacy DSS QDC2: Digicipher II QPSK QDVB: Legacy DVB LQPSK: DVB-S2 QPSK L8PSK: DVB-S2 8PSK TQPSK: Turbo QPSK T8PSK: Turbo 8PSK

Figure 6-6 Edit Satellite Details

Vertical Low

Frequency (MHz): 11960

Symbol Rate: 20000

FEC Code: 3/4

Satellite ID: 0xFFFE

Decoder Type: QDVB

- If the satellite is a custom user-defined satellite, you can change the additional parameters listed below.

Parameter	Description
Satellite Name	User-defined name (e.g., User Sat 1)
Region	Africa, Asia, Australia/New Zealand, Central/South America, Europe, or North America
Orbital Slot (Longitude)	Longitude of the satellite's position, using the following format: xxx.xxE or xxx.xxW (leading zeros and decimal values are optional)
Pre-Skew	-90° to +90°

Figure 6-7 Additional Parameters for User-defined Satellite

Satellite Name: My Satellite

Region: Asia

Orbital Slot: 123E

Pre-Skew: 0.0

NOTE: LNB type and local oscillator frequencies cannot be modified, as they are properties of the LNB installed in the antenna.



7. Switching Satellites

This section explains how to switch between multiple satellites installed in the antenna.

Contents

Automatic Satellite Switching for Linear, DISH Network, or Bell TV.....	65
Automatic Satellite Switching for DIRECTV	69
Selecting Automatic Switching Mode.....	76
Selecting the Master Receiver	77
Manual Satellite Switching.....	78
Tri-Americas Satellite Switching.....	79

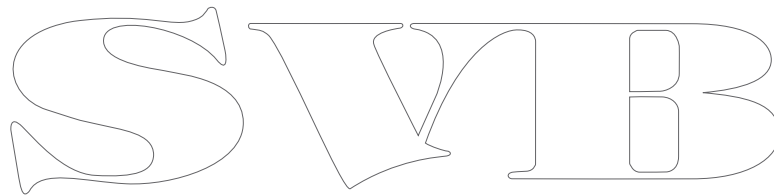

Automatic Satellite Switching for Linear, DISH Network, or Bell TV

In Automatic satellite switching mode, the TV-Hub can accept DiSEqC satellite change commands from linear, DISH Network, or Bell TV receivers that are either:

- Connected directly to the TV-Hub's "Receiver" port
- Equipped with an IP AutoSwitch

IP AutoSwitches send DiSEqC commands via your onboard local area network (LAN). See "[Network Settings](#)" on [page 15](#) for network setup details.

NOTE: An IP AutoSwitch is not required for a receiver connected directly to the TV-Hub because the TV-Hub has a built-in IP AutoSwitch.

Figure 7-1 IP AutoSwitch Connections

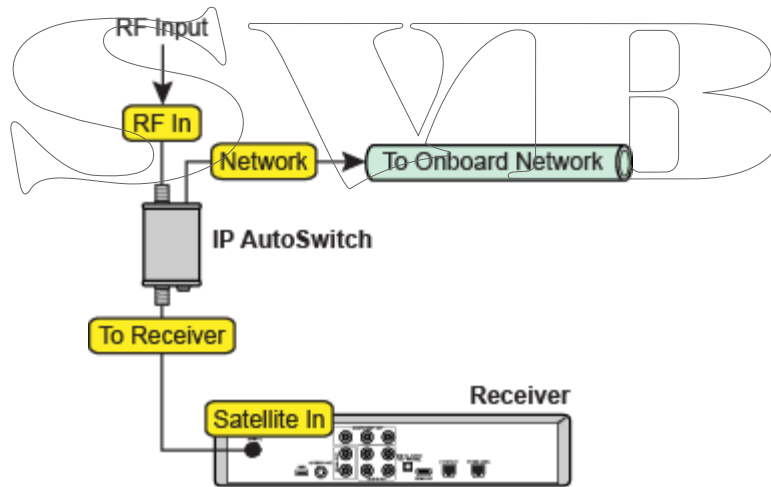

Each receiver and IP AutoSwitch needs to be set up for automatic switching, as explained in the following topics:

- "[Setting Up a Linear Receiver for Automatic Switching](#)" on [page 66](#)
- "[Setting Up a DISH Network/Bell TV Receiver for Automatic Switching](#)" on [page 67](#)
- "[Setting Up an IP AutoSwitch](#)" on [page 68](#)

Setting Up a Linear Receiver for Automatic Switching

For automatic switching to work properly with your linear receivers, be sure to set up the satellites in each receiver in the same order as they are set up in the antenna. See [“Configuring a Linear Receiver for Automatic Switching”](#) on page 37 for details.

SVIB

Setting Up a DISH Network/Bell TV Receiver for Automatic Switching

For automatic switching to work properly with your DISH Network or Bell TV receivers, be sure to observe the following requirements:

- Make sure each receiver is DISH pro-compatible. Look for the DISH Pro logo on the box.
- Select a preset satellite group (see [“Selecting a Satellite Group” on page 55](#)). User-defined groups are limited to manual satellite switching only.
- Run the TracVision Setup Wizard and initiate a Check Switch test on the receiver when prompted to do so. See [“Running a Check Switch Test on a DISH Network or Bell TV Receiver” on page 45](#) for details. You can launch the Setup Wizard from the web interface (go to Settings > General Settings).

NOTE: In some cases, a DISH Network receiver might automatically switch from a high-definition (HD) channel to its standard-definition (SD) equivalent. To prevent this from happening, always tune to the HD-only channels at the upper range of the channel list (above 1000), or set up the receiver to block the SD channels (from the Main Menu, select Locks:5 > Channel Locks:2).

Setting Up an IP AutoSwitch

Whenever you install a new IP AutoSwitch, you need to add it to the Autoswitch page of the web interface. Enter the IP AutoSwitch's serial number and assign it a friendly name (e.g., "Salon"). You can find the serial number on the bottom of the IP AutoSwitch.

Figure 7-2 Adding an IP AutoSwitch to the Autoswitch Page



Automatic Satellite Switching for DIRECTV

In Automatic satellite switching mode, the TV-Hub can accept commands from the master SWM-compatible DIRECTV receiver to automatically switch between the 101W and 119W satellites. (To learn more about SWM technology, see [“Understanding DIRECTV SWM Technology” on page 75.](#)) The TV-Hub communicates with the master receiver via the TV-Hub’s Ethernet port link to your DIRECTV coax network. Set up this communication link with your SWM-compatible receivers, as explained in the following topics:

- [“DIRECTV Coax Network Connections” on page 70](#)
- [“Additional Equipment for Old DIRECTV Receivers” on page 72](#)
- [“Setting Up a DIRECTV Receiver for Automatic Switching” on page 73](#)

NOTE: The 119W satellite only carries local channels for certain regions of the country. (You can find a list of these regions in the Setup Wizard.) If your locals are carried on DIRECTV’s main 101W satellite, you do not need to switch satellites.

DIRECTV Coax Network Connections

DIRECTV recently adopted coax networking technology, by which both satellite TV signals and network communications data are carried by the coax cables. This simplifies installation, since Ethernet cables don't need to be run to all of the receivers.

Non-Genie Configurations

If a Genie DVR (HR44 or HR34) is not present on your DIRECTV SWM network, you need to install a DECA with power supply and DC to RF adapter, collectively referred to as a DECA Broadband Kit (KVH part no. 19-0860) and formerly called a Cinema Connection Kit. When connected to the SWM splitter and the TV-Hub's Ethernet port, either directly or via an onboard router, the DECA relays messages between the DIRECTV coax network and the Ethernet network.

Figure 7-3 Non-Genie Configuration

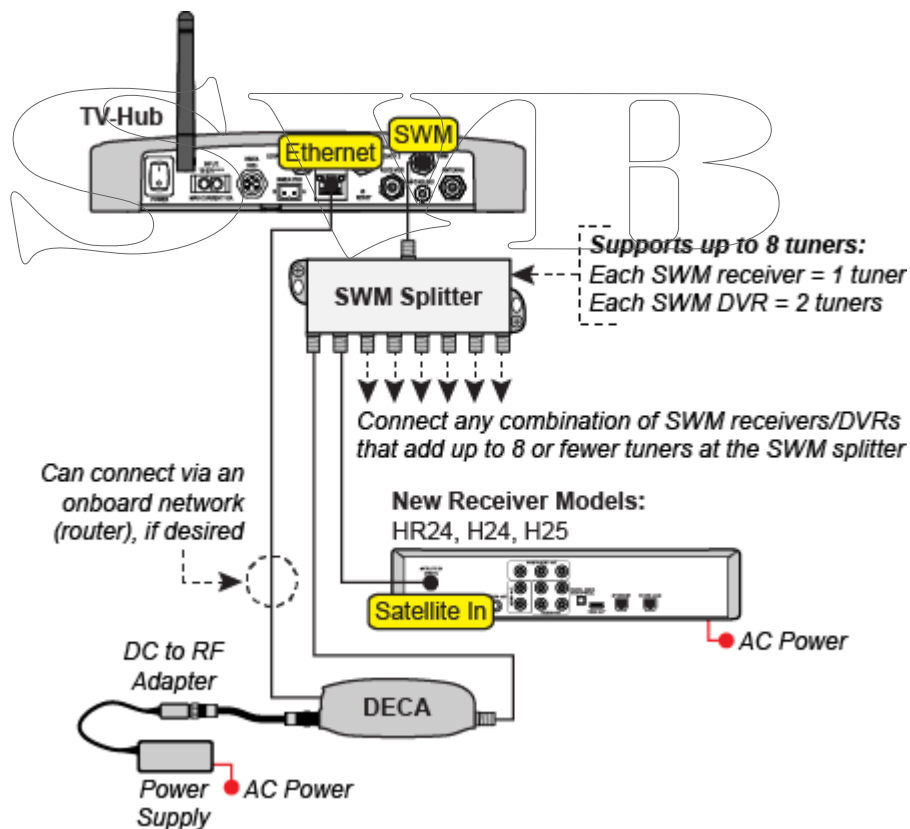

Genie Configurations

Full DECA Broadband functionality is built into Genie DVRs (HR44 or HR34). So if a Genie DVR is present on your DIRECTV SWM network, no external DECA Broadband kit is required. Just connect the Genie's Ethernet port to the TV-Hub's Ethernet port, either directly or via an onboard router. The Genie DVR provides the link between the DIRECTV coax network and the Ethernet network.

NOTE: If you cannot easily connect the Genie DVR's Ethernet port to the TV-Hub or an onboard network, you can use a DECA Broadband Kit, as explained in "Non-Genie Configurations" on page 70.

NOTE: Genie clients cannot switch satellites; they can only view programming carried by the satellite that is currently selected.

Figure 7-4 Genie Configuration

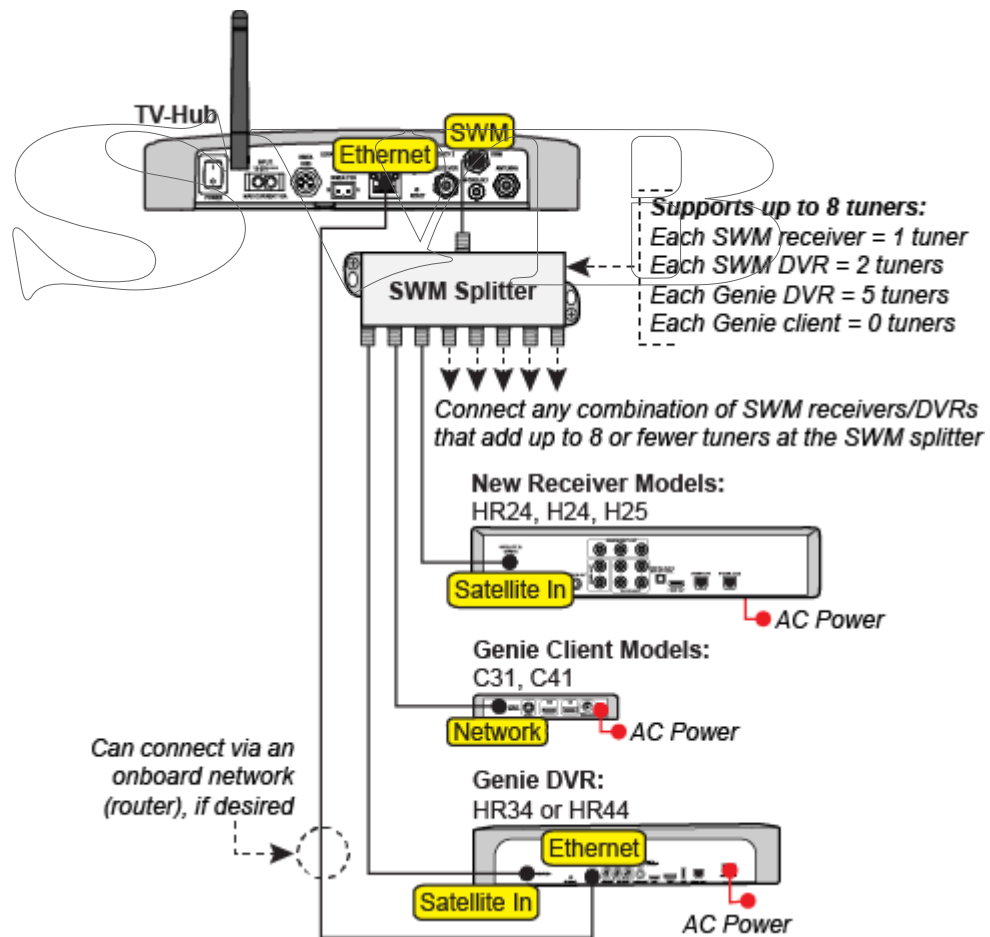

Additional Equipment for Old DIRECTV Receivers

In addition to the DECA Broadband Kit or a Genie DVR, you might need to connect an additional device to individual receiver(s), depending on the model.

Old Receiver Models	Additional Device Required
H21, H22, H23, HR21, HR22, HR23	DECA (included in DECA Broadband Kit), KVH part no. 19-0860
H20*	Band Stop Filter, KVH part no. 19-0868

* Model HR20-100 requires additional devices. Contact KVH Technical Support for details.

Connect these additional device(s) in-line between the receivers and the SWM splitter.

Figure 7-5 Additional Equipment for Older Receivers

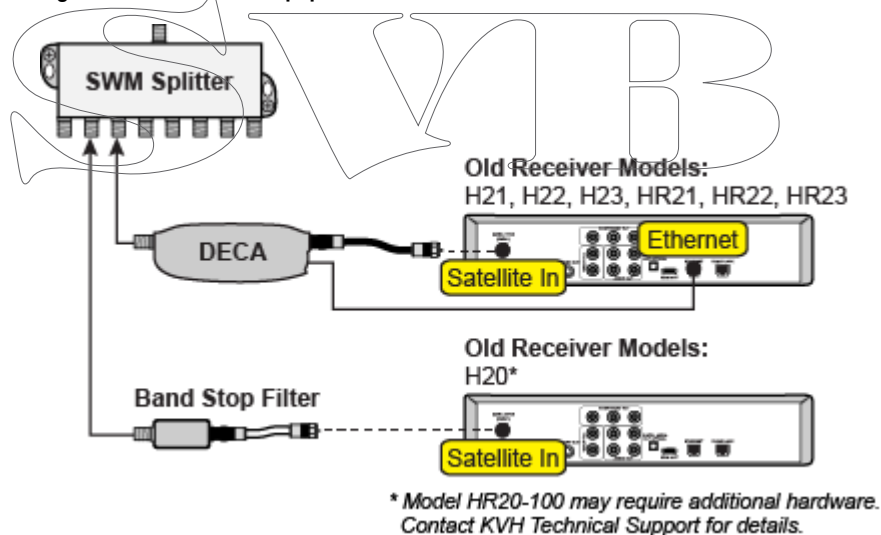

H21, H22, H23, HR21, HR22, and HR23 Models

These receivers do not have built-in DECA functionality, but they have an Ethernet port for network connectivity. An additional DECA (KVH part no. 19-0860) is required for each of these receivers to support coax networking, supplying the satellite TV signal to the receiver's "Satellite In" port and network communications data to its Ethernet port. (If there are two of each port, use the "Satellite In 1" and "Ethernet 1" ports.)

NOTE: Each DECA that you connect directly to a receiver is powered by the receiver. They do not require the separate power supply included in the DECA Broadband Kit.

H20 Model

This receiver is not network-ready. It is only designed to receive a satellite TV signal via its "Satellite In" port. Since both the satellite TV signal and network communications data are present on the coax cables, a band stop filter (KVH part no. 19-0868) is required to block the network data to prevent potential damage to the receiver. Since the H20 cannot communicate over the network, it cannot control satellite selection.

Important!

Be sure to connect all band stop filters before connecting the coax cables.

Setting Up a DIRECTV Receiver for Automatic Switching

During system installation, your SWM-compatible receivers should have been set up for you. (See the Installation Guide for details.) If you wish to add a new SWM-compatible receiver, follow these steps:

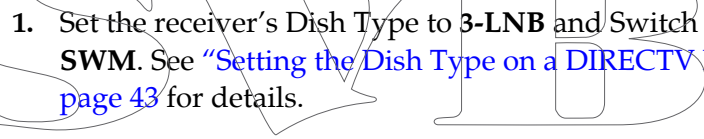
- 
1. Set the receiver's Dish Type to **3-LNB** and Switch Type to **SWM**. See ["Setting the Dish Type on a DIRECTV Receiver" on page 43](#) for details.
 2. Set up the receiver to allow external device access. See ["Allowing External Access on a DIRECTV Receiver" on page 42](#) for details.
 3. Assign a unique static IP address to the new receiver. See ["Configuring DIRECTV Receivers for Automatic Switching" on page 38](#) for details.
 4. Add the new receiver to the Autoswitch page of the web interface. Enter the receiver's static IP address and assign it a friendly name (e.g., "Salon").

NOTE: If the TV-Hub is unable to communicate with the receiver, try resetting the receiver (press its red reset button or unplug it, wait 15 seconds, then plug it back in and turn it on).

Figure 7-6 Adding a DIRECTV Receiver to the Autoswitch Page

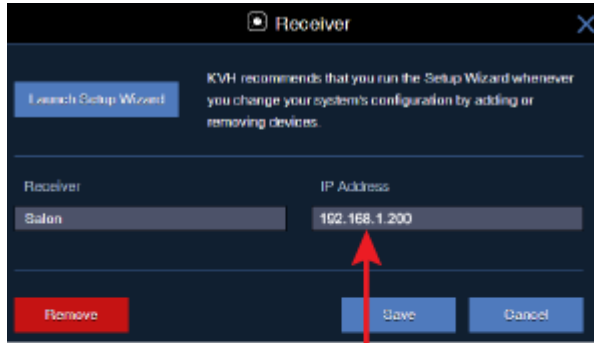

SVIB

Understanding DIRECTV SWM Technology

The TV-Hub has a built-in DIRECTV single wire multiswitch (SWM), allowing you to connect multiple SWM-compatible receivers via a single coax cable. At startup, the SWM allocates one of eight channels to each tuner it detects on the cable. Recording devices will consume more than one channel, as they offer the ability to record on one or more channels while watching another.

Device	Tuners
SWM Receiver	1
SWM DVR	2
Genie	5
Genie Client	0

Figure 7-7 DIRECTV SWM Technology

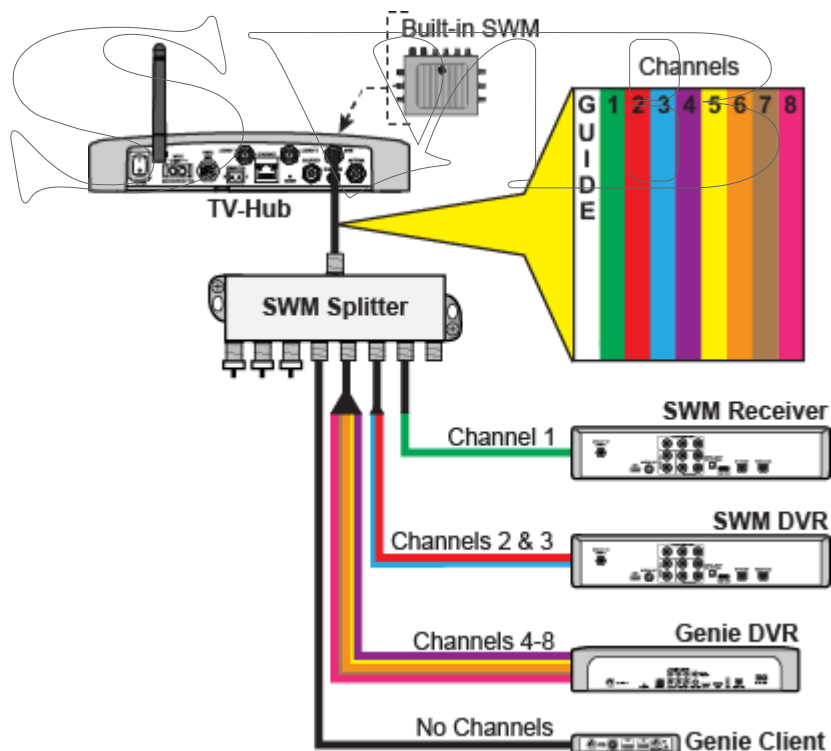

Selecting Automatic Switching Mode

To select automatic switching, simply select the Automatic satellite switching mode at the Home page of the web interface.

Figure 7-8 Automatic Satellite Switching on Home Page

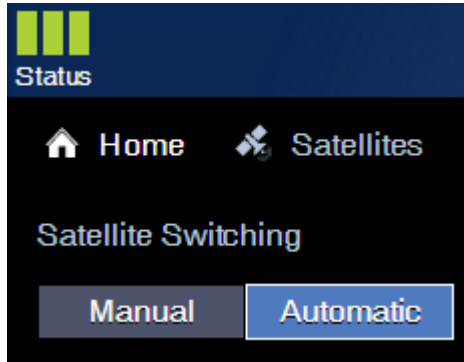

SVIB

Selecting the Master Receiver

The master receiver controls satellite selection. The TracVision antenna will switch between satellites automatically as you change channels using the master receiver's remote control. All other receivers will only be able to select channels that are carried by the currently selected satellite.

NOTE: The system must first be set to Automatic satellite switching mode before you can select a master receiver. See "Selecting Automatic Switching Mode" on page 76.

To make a different receiver the master, simply select it on the Home page of the web interface.

Figure 7-9 Master Receiver Selection



As an alternative, if the receiver is connected to an IP AutoSwitch, you can press the **Master Select** button on the IP AutoSwitch to make its associated receiver the master.

Figure 7-10 IP AutoSwitch Master Select Button

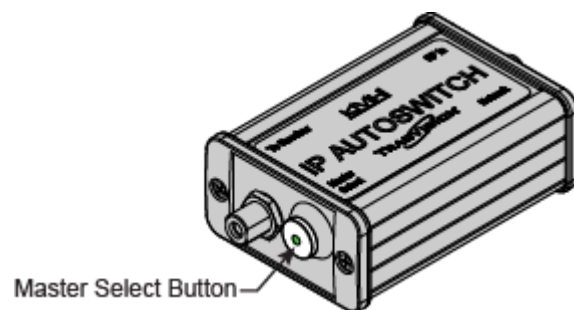

Manual Satellite Switching

Even if your system is set up for automatic satellite switching, you always have the option to manually switch satellites at the Home page of the web interface. Simply select the Manual satellite switching mode then select the desired satellite from the displayed list of installed satellites.

Important!

When you select Manual switching mode, the system no longer responds to receiver satellite change commands. To restore automatic switching, you need to select the Automatic satellite switching mode at the Home page.

Figure 7-11 Manual Satellite Selection on Home Page

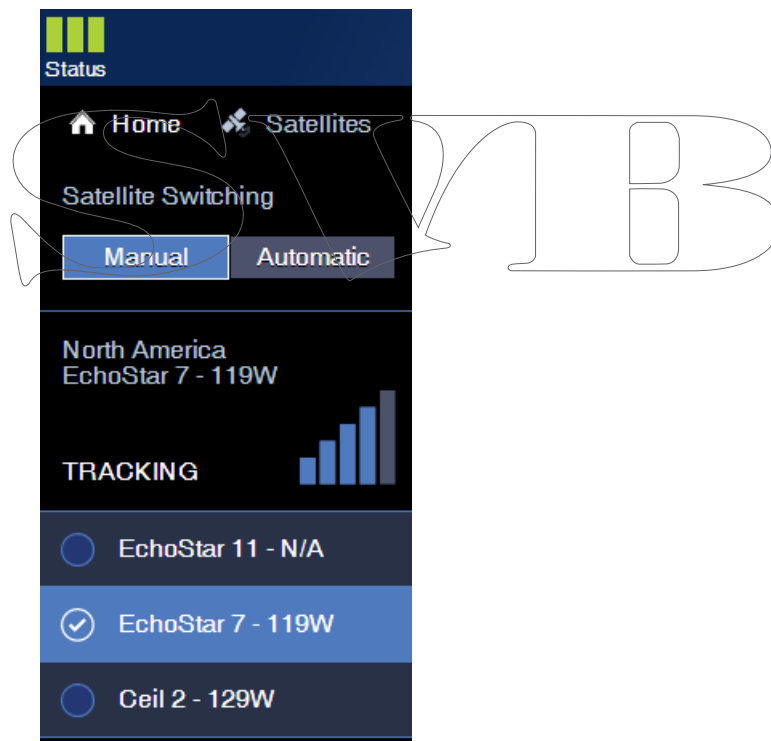

Tri-Americas Satellite Switching

If your antenna is equipped with a Tri-Americas LNB, you don't need to swap the LNB inside the antenna when you switch between DIRECTV U.S. and DIRECTV Latin America services. The LNB can receive satellite signals from either service.

However, when you switch between a DIRECTV U.S. satellite (101W or 119W) and the DIRECTV Latin America satellite (95W), you need to set the switch on the 22KHz tone generator to the correct position for the selected service (refer to the Installation Guide for wiring details):

Service	Satellite	22KHz Switch
DIRECTV U.S.	101W or 119W	OFF
DIRECTV Latin America	95W	ON

Figure 7-12 22KHz Tone Generator

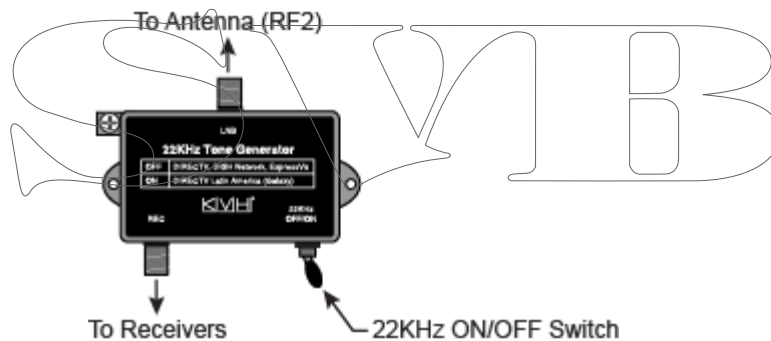

Automatic switching is possible between the 101W and 119W satellites, as explained in [“Automatic Satellite Switching for DIRECTV” on page 69](#). To switch between a DIRECTV U.S. satellite and a DIRECTV Latin America satellite, you need to manually switch using the web interface (see [“Manual Satellite Switching” on page 78](#)).



8. Troubleshooting

This section identifies some basic problems along with their possible causes and solutions. It also explains what the status lights and error messages indicate, how to view the system logs and information, and how to get technical support.

Contents

Basic Checks	83
Status Information on the Home Page.....	85
TV-Hub Status Indicators.....	87
IP AutoSwitch Status Indicator	90
Error Messages	91
System Logs.....	95
System Information.....	98
Technical Support.....	100

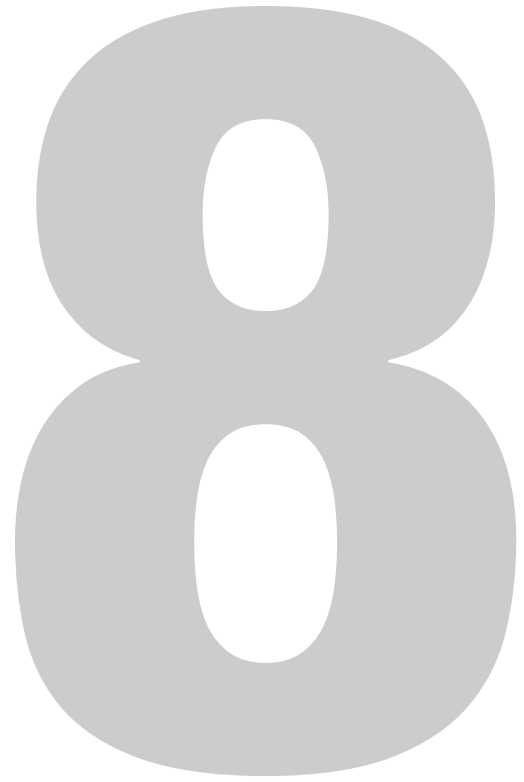
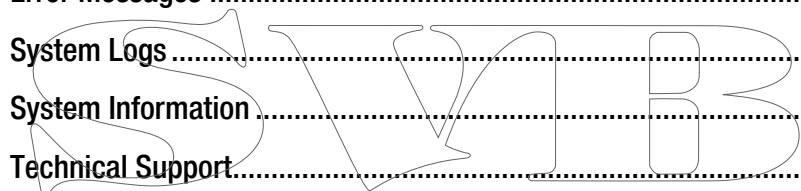

Basic Checks

If you are experiencing a problem receiving satellite TV with your TracVision system, first check the following:

Check the System Status Information

Check the status indicators in the upper-left corner of the Home page of the web interface, or check the three lights on the front of the TV-Hub itself. All three should be lit solid green. See “[TV-Hub Status Indicators](#)” on page 87 for details. Also look for an error message on the Home page (see “[Error Messages](#)” on page 91).

Check for Satellite Signal Blockage

If the antenna is continuously searching for the satellite, check the area around the antenna for blockage. The antenna needs an unobstructed view of the sky to receive satellite signals. See “[Avoiding Blockage](#)” on page 12 for details. Excessive dirt on the radome and severe weather can also affect reception. If there is no blockage, you might be located outside the coverage area of the selected satellite. Visit www.kvh.com/footprint for details.

NOTE: The Home page of the web interface indicates the direction in which the antenna is pointing.

Make Sure Your Receivers Are Set Up Properly

Your satellite TV receivers might need to be configured for the desired satellite(s) and/or operating mode. Refer to “[Receiver Settings](#)” on page 35 for details.

Check Power and Cables

Make sure power is applied to all system components. Also make sure all cables are connected tightly. Refer to the Installation Guide for wiring details.

Make Sure the Software and Satellite Library Are Up-to-Date

To update the system to the latest software version, refer to “[Updating the Software](#)” on page 106. To update the satellite library, refer to “[Updating the Satellite Library](#)” on page 104.

Adjust the LNB Skew Angle (Linear Systems Only)

If your antenna is not equipped with automatic skew, you need to manually set the antenna's LNB to the correct skew angle for the selected satellite and your current location. Refer to ["Adjusting the LNB Skew Angle \(Linear Only\)"](#) on page 27 for details.

Restart the System

Try restarting the system at the web interface (see ["Restarting the System"](#) on page 109). If you cannot access the web interface, turn off the TV-Hub at the rear panel power switch, then turn it back on.

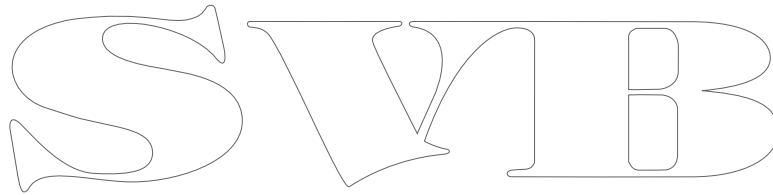

Status Information on the Home Page

The Home page of the web interface provides basic system status information, as described below.

Figure 8-1 Home Page

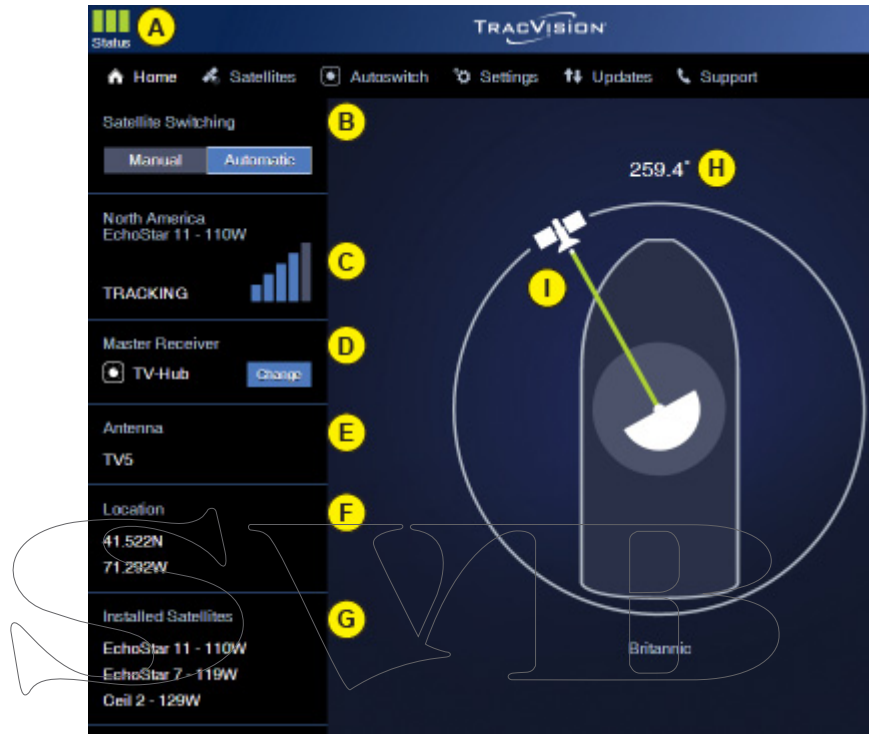

Item	Description
A	Three status indicators match the physical status lights on the TV-Hub (see “TV-Hub Status Indicators” on page 87)
B	Current satellite switching mode: Automatic or Manual
C	Currently selected satellite, satellite signal strength, and general status of the antenna: <ul style="list-style-type: none"> • Tracking • Searching • Cable Unwrap • Initializing • Boot • Idle • Error
D	Currently selected master receiver (only shown in Automatic satellite switching mode)
E	Antenna model

Item	Description
F	Latitude/longitude of your current location, based on GPS input or manual entry
G	List of satellites currently installed in the antenna
H	Your current true heading (requires NMEA input)
I	Direction to the satellite, in relation to the bow of the vessel; a green line between the antenna and the satellite indicates the antenna is tracking the satellite

The image shows the letters 'SVIB' in a large, stylized, outlined font. The letters are white with a black outline. The 'S' is a simple curve, the 'V' is a sharp downward-pointing triangle, the 'I' is a vertical bar with a small dot above it, and the 'B' is a rounded shape with a vertical bar through its center.

TV-Hub Status Indicators

Status lights on the Home page of the web interface and on the front of the TV-Hub itself indicate the current status of the system and can help you identify problems quickly.

Figure 8-2 TV-Hub Status Lights

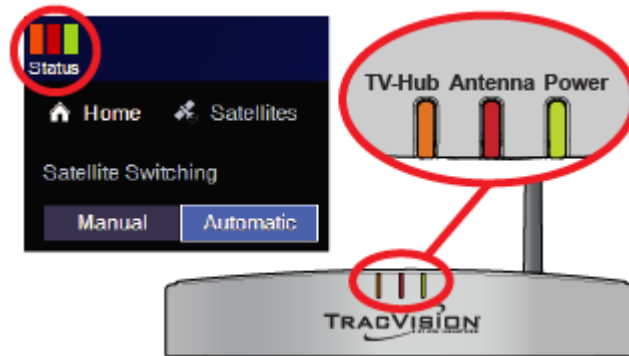

During normal operation, all three lights should be lit green. The following tables explain what the different light conditions indicate. If an error condition exists, view the error message on the Home page of the web interface (see [“Error Messages”](#) on page 91).

Important!

All three status lights will alternate orange whenever a software update is in progress. Updates might take up to 40 minutes. Do not turn off the system during this time.

NOTE: During startup, each status light will illuminate orange for a few seconds.

TV-Hub Light

The table below explains what the TV-Hub light indicates.

State	Description
Off	TV-Hub is powered off, or there is no power input
Green	TV-Hub is operating normally
Green, Flashing	TV-Hub is initializing
Orange, Flashing	TV-Hub is operational, but a minor error exists that you might be able to fix
Red	TV-Hub is not operational; a major error exists – contact KVH Technical Support
Red, Flashing	TV-Hub is not operational; a major error exists that you might be able to fix

Antenna Light

The table below explains what the Antenna light indicates.

State	Description
Off	No power input to the antenna
Green	Antenna is tracking a satellite
Green, flashing	Antenna is initializing or searching for a satellite
Orange	Antenna has been halted by a technician
Orange, flashing	Antenna is operational, but a minor error exists that you might be able to fix
Red	Antenna is not operational; a major error exists – contact KVH Technical Support
Red, Flashing	Antenna is not operational; a major error exists that you might be able to fix



Power Light

The table below explains what the Power light indicates.

State	Description
Off	TV-Hub is powered off, or there is no power input
Green	Good input power
Red, Flashing	Input power is unacceptable; a major error exists that you might be able to fix

SVIB

IP AutoSwitch Status Indicator

A status light on the IP AutoSwitch indicates the current status of the IP AutoSwitch.

Figure 8-3 IP AutoSwitch Status Light

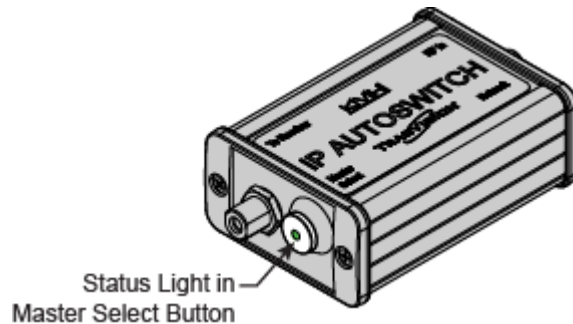

The table below explains what the IP AutoSwitch status light indicates.

State	Description
Off	No power input from the receiver
Green	Registered with the TV-Hub and currently selected as the master
Orange	Registered with the TV-Hub but not currently selected as the master
Orange, Flashing	Initializing
Red	Detected one of the following errors: <ul style="list-style-type: none">• Unable to communicate with the TV-Hub• Network is not detected• Unable to register with the TV-Hub

Error Messages

If any of the Status indicators on the Home page of the web interface are flashing orange, flashing red, or solid red, click on it to view the error message.

Figure 8-4 Example of Error Messages under Status Indicators

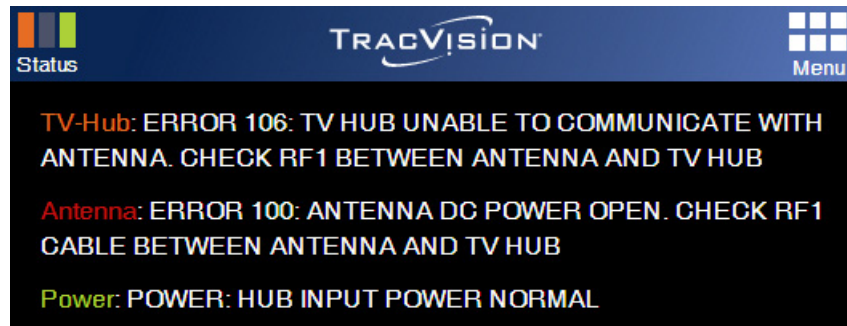

The table below lists all of the possible error messages. Many of these faults should only be repaired by a KVH-certified technician; contact KVH Technical Support for assistance (see [“Technical Support” on page 100](#)).

Error	Description
100	There is an open circuit in the DC power wires running between the antenna and the TV-Hub. The TV-Hub detects no DC current feed to the antenna. Check the RF1 cable between the antenna and the TV-Hub.
101	There is a short circuit in the DC power wires running between the antenna and the TV-Hub. The TV-Hub detects an overload condition. Check the RF1 cable between the antenna and the TV-Hub.
102	The TV-Hub is not providing the proper DC voltage to the antenna (should be 37.8-46.2 VDC). Contact KVH.
104	The software update file you selected is corrupt. Try a new update file.
105	The TV-Hub is unable to read from or write to its EEPROM. Contact KVH.
106	The TV-Hub has lost communications with the antenna. Check the RF1 cable between the antenna and the TV-Hub.

Error	Description
107	The TV-Hub internal temperature exceeds acceptable limits. If the problem persists, you might need to relocate the unit to an area that provides better ventilation.
108	An automated reboot of the TV-Hub is in process to resolve low memory. No action is required.
109	The TV-Hub is running low on memory but it should be able to recover without a reboot.
111	The TV-Hub is unable to initialize its built-in wireless access point (WAP). Contact KVH.
119	The 24 VDC power to the internal SWM module is out of range. DIRECTV outputs are disabled. Contact KVH.
124	The software update file you selected is not valid for your antenna model. Try a new update file.
128	The software update failed. Retry updating the software. If it fails again, check the RF1 cable between the antenna and the TV-Hub.
129	One of the TV-Hub's power supplies is out of range. Contact KVH.
130	The TV-Hub DC input voltage is out of range (should be 10-30 VDC). Check the power source that is supplying DC power to the TV-Hub.
131	The TV-Hub detects no DC current feed to the antenna, following a period of normal operation. Check the RF1 cable between the antenna and the TV-Hub.
200	The antenna is not receiving adequate DC power from the TV-Hub. Check the RF1 cable between the antenna and the TV-Hub.
202	The antenna's main board has lost communications with the skew motor. Contact KVH.
203	The antenna's main board has lost communications with the azimuth and elevation motors. Contact KVH.
204	The antenna's main board has lost RF communications. Contact KVH.
205	The antenna's azimuth motor has a power failure. Contact KVH.

Error	Description
206	The antenna's azimuth motor or limit switch failed. Contact KVH.
207	The antenna's elevation motor has a power failure. Contact KVH.
208	The antenna's elevation motor or limit switch failed. Contact KVH.
217	The antenna's skew motor has a power failure. Contact KVH.
218	The antenna's skew motor or limit switch failed. Contact KVH.
221	The system is not receiving any data from the GPS. Contact KVH.
222	The antenna's internal temperature exceeds acceptable limits. Turn off the system and allow it to cool.
223	The antenna's main board has lost gyro calibration data. A technician should calibrate the antenna's gyros.
226	The antenna has lost RF communications. Contact KVH.
227	The antenna's RF software might be corrupted. Contact KVH.
228	The antenna has lost RF communications. Contact KVH.
229	The antenna's RF software might be corrupted. Contact KVH.
231	The antenna's RF software might be corrupted. Contact KVH.
232	The antenna's RF software might be corrupted. Contact KVH.
241	The antenna's main board detects a power failure. Contact KVH.
265	The GPS is unable to acquire a fix. Check for blockage or RF interference around the antenna.
269	The main antenna processor detects that LNB voltage is out of range. Contact KVH.
270	The azimuth or elevation gyro needs to be replaced. Contact KVH.

Error	Description
272	The antenna's main software does not match the antenna type. Contact KVH.
273	The antenna's motor software does not match the antenna type. Contact KVH.
274	The antenna's skew software does not match the antenna type. Contact KVH.
275	The azimuth or elevation gyro needs to be replaced. Contact KVH.
276	The antenna's main board has lost accelerometer calibration data. A technician should calibrate the antenna's accelerometer.

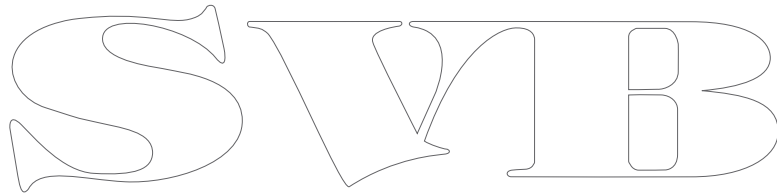
A large, stylized outline logo consisting of the letters 'S', 'V', 'I', and 'B' in a decorative, serif font. The letters are interconnected and have a classic, elegant appearance.



System Logs

Two system logs are available on the Support page of the web interface to capture historical system data:

- [Operational Log](#) (see [“Operational Log”](#) on page 96)
- [Event Log](#) (see [“Event Log”](#) on page 97)

SVIB

Operational Log

The Operational Log, when initiated, records all messages that the antenna system generates within a period of several minutes. To start a new log or view the current log, select **Operational Log** on the Support page of the web interface. Then select the desired option:

- **View Current Log:** This option simply opens the current Operational Log. You can save this log as a text file (filename: IPACU.serial.log) and send it to a technician or KVH Technical Support.
- **Start New Log:** This option deletes the current Operational Log and begins recording a new one.
- **Restart System & Start New Log:** This option deletes the current Operational Log, restarts the antenna, and begins recording a new Operational Log. This log will include the system's startup messages, which include the results of various self-test routines.

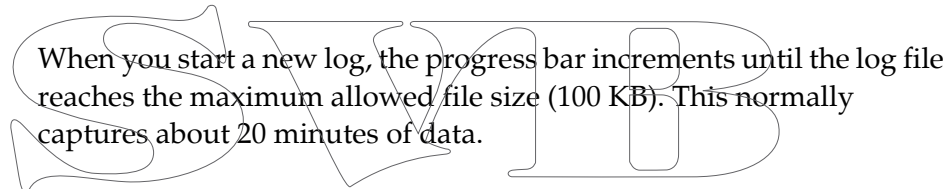

Figure 8-5 Operational Log Options

Operational Log

When initiated, the Operational Log records all messages generated by the antenna system.

Current log status: 0%

0% 100%

View Current Log

Choose this option to view the current Operational Log.

Start New Log

Choose this option to delete the current Operational Log and begin recording a new one.

Restart System and Start New Log

Choose this option to delete the current Operational Log, restart the antenna, and begin recording a new Operational Log that includes startup self-test results. This information is very useful for diagnostics.

Event Log

The Event Log keeps a historical record of all major system events, including any error messages the antenna system generates. On the Support page of the web interface, select **Event Log**. You can then save the log file (filename: majorError.log) to your computer and e-mail it to KVH Technical Support.

Figure 8-6 Event Log

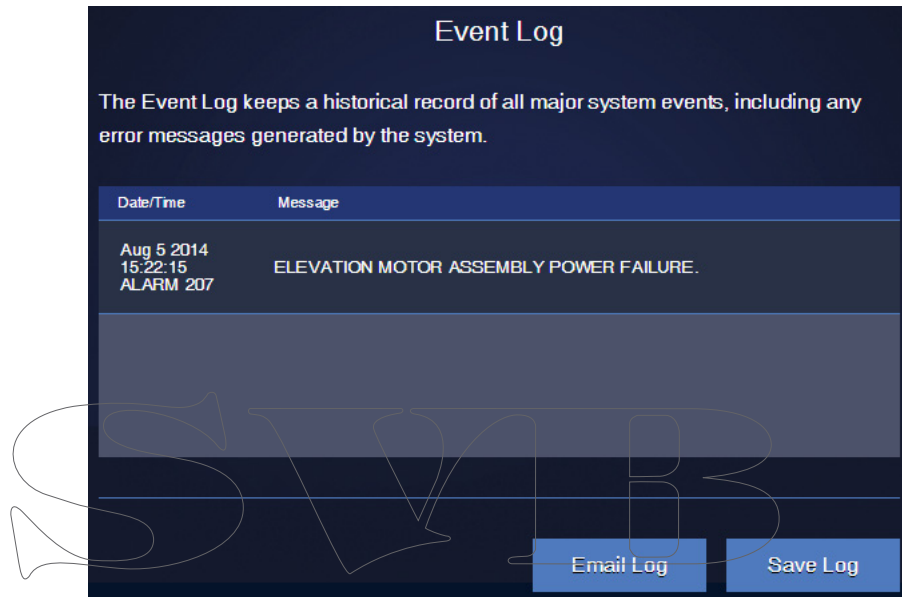

System Information

You can find the serial numbers, software versions, voltages, and other technical information for the TV-Hub and antenna on the Support page of the web interface (go to Support > System Info). You will need this information whenever you contact KVH Technical Support. It is very useful for diagnostics.

Figure 8-7 System Info: TV-Hub



The screenshot shows a dark blue background with white text. At the top, the title 'TV-Hub' is centered. Below it, a list of system information is displayed in a two-column format. The items are: Serial Number (140300683), Date/Time (2014-08-15T13:14:53Z), Version (1013), Web UI Version (805:6a22c60c0cd2), Satellite Library Version (6.6), Satellite Service (DIRECTV), Support IP (10.221.0.32), DiSEqC Version (1.01), and IP AutoSwitch Version (1.01). A large, faint watermark 'SMBB' is visible across the middle of the screenshot.

TV-Hub	
Serial Number	140300683
Date/Time	2014-08-15T13:14:53Z
Version	1013
Web UI Version	805:6a22c60c0cd2
Satellite Library Version	6.6
Satellite Service	DIRECTV
Support IP	10.221.0.32
DiSEqC Version	1.01
IP AutoSwitch Version	1.01

Figure 8-8 System Info: Antenna Unit

Antenna Unit	
Model	TV5
System ID	TV5SK
Serial Number	999999999
Main Version	1.00
RF Version	1.00
FPGA Version	1
AZ/EL Version	1.00
SKEW Version	1.00
LNB Type	Circular
LNB Version	N/A
Antenna Power	
Main 42 VDC	41.4
Motor 32 VDC	32.3
8 VDC	8.1
5 VDC	5.0
LNB 13/18 VDC	18.0
Temperature(Celsius)	41.0
Operational Hours	2810.5

Technical Support

The TracVision system is a sophisticated electronic device; only specially trained KVH-certified technicians have the tools and expertise necessary to diagnose and repair a system fault. Therefore, if you experience an operating problem or require technical assistance, please contact KVH Technical Support:

North/South America, Australasia:

Phone: +1 401 847-3327

E-mail: support@kvh.com

Europe, Middle East, Africa, Asia-Pacific:

Phone: +45 45 160 180

E-mail: support@emea.kvh.com

Please have your system serial numbers and software versions handy before you call (see “System Information” on page 98).

Remote Diagnostics

If your TV-Hub is connected to the Internet via an onboard network, KVH Technical Support might be able to troubleshoot your system remotely over the Internet.

Important!

KVH Technical Support will guide you through the process of enabling remote diagnostics on the TV-Hub. Enable this connection only when requested by KVH Technical Support.

Figure 8-9 Remote Access

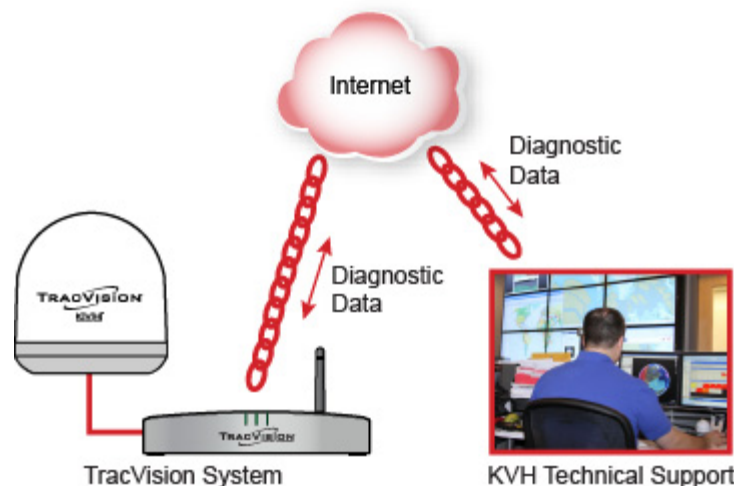



9. Maintenance

This section explains how to perform preventive maintenance to keep the system in tip-top shape. It also explains how to update the software and satellite library, and restart system components.

Contents

Preventive Maintenance	103
Updating the Satellite Library	104
Updating the Software.....	106
Corrective Maintenance.....	108
Restarting the System	109

SVIB

9

Preventive Maintenance

The following tasks should be performed periodically to help maintain peak performance:

- Vacuum the vents on the TV-Hub. Air needs to flow through these vents to cool the electronic components and prevent overheating.

Figure 9-1 Vents on TV-Hub

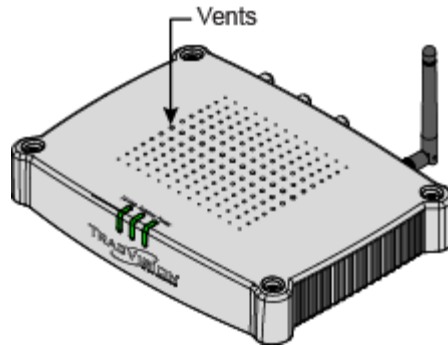

- Clean the outside of the antenna with fresh water to remove grime. Dirt buildup can affect reception of satellite signals. You may use mild detergent, but avoid abrasive cleansers and high-pressure water.
- Inspect the cable connections at the TV-Hub for any wear and tear. Repair any damaged cables.
- Ensure the system is running the latest software version. See ["Updating the Software" on page 106](#) for details. Also make sure the TV-Hub's satellite library is up to date. See ["Updating the Satellite Library" on page 104](#) for details.

Updating the Satellite Library

Service providers occasionally change the tracking parameters of their satellites, necessitating an update to the data in the TracVision satellite library. You can update your system's satellite library to the latest version at any time by downloading the file from KVH's Update server and uploading it to the TV-Hub. When you update the library, the new version simply overwrites the previously installed version.

Important!

With the exception of user-defined satellites, updating the satellite library overwrites any changes you have made to the satellites' tracking parameters. All parameters for preset satellites revert to their factory default settings.

Use one of the following methods to update the satellite library:

Using an Onboard Network with Internet Access

If the TV-Hub is connected to an onboard network that has an Internet connection, you can use that connection to download the library file. Follow these steps:

1. Connect your computer to the same network as the TV-Hub.
2. At the Updates page of the web interface, select the satellite library. Then select **Download Update**. This will download the latest version of the library file onto your computer.
3. Select **Install Update**. Then navigate to and select the library file (it has a .xml extension) saved on your computer. It will only take a few seconds for the update to complete.

Using a Smartphone or Tablet

If you have an Apple iOS or Google Android smartphone or tablet, and your device has an Internet connection, you can use the TracVision TV/RV App to download the latest library file and upload it to the system. You can download the App for free from the Apple iTunes App Store or Google Play Store.

Using a Computer with Internet Access

If your computer has an Internet connection, you can use that connection to download the library file. Follow these steps:

1. Download the latest version of the library file onto your computer from the KVH website (go to www.kvh.com/Support/Product-Support-Library/Software-Updates).
2. Once you have downloaded the file onto your computer, use the same computer to access the TV-Hub's web interface (see "Accessing the Web Interface" on page 14).
3. At the Updates page of the web interface, select the satellite library then select **Install Update**. Navigate to and select the library file (it has a .xml extension) saved on your computer. It will only take a few seconds for the update to complete

Figure 9-2 Satellite Library Update



Updating the Software

KVH periodically releases new versions of software to enhance the performance and capabilities of the system. You can update your system to this latest software at any time by downloading the file from KVH's web server and uploading it to the system. When you update the software, the new version simply overwrites the previously installed version. A single software package includes updates to all components in the antenna and TV-Hub.

Use one of the following methods to update the software:

Using an Onboard Network with Internet Access

If the TV-Hub is connected to an onboard network that has an Internet connection, you can use that connection to download the software. Follow these steps:

1. Connect your computer to the same network as the TV-Hub.
2. At the Updates page of the web interface, select the antenna. Then select **Download Update**. This will download the latest version of the software onto your computer via the onboard network's Internet connection.
3. Select **Install Update**. Then navigate to and select the update file (it has a .kvh extension) saved on your computer.
4. Wait for the update to complete. It may take up to 45 minutes.

Using a Smartphone or Tablet

If you have an Apple iOS or Google Android smartphone or tablet, and your device has an Internet connection, you can use the TracVision TV/RV App to download the latest software and upload it to the system. You can download the App for free from the Apple iTunes App Store or Google Play Store.

Using a Computer with Internet Access

If your computer has an Internet connection, you can use that connection to download the software. Follow these steps:

1. Download the latest version of software onto your computer from the KVH website (go to www.kvh.com/Support/Product-Support-Library/Software-Updates).

2. Once you have downloaded the file to your computer, use the same computer to access the TV-Hub's web interface (see ["Accessing the Web Interface" on page 14](#)).
3. At the Updates page of the web interface, select the antenna then select **Install Update**. Navigate to and select the update file (it has a .kvh extension) saved on your computer.
4. Wait for the update to complete. It may take up to 45 minutes.

NOTE: The TV-Hub's status lights will alternate orange while the update is in progress.

Figure 9-3 Antenna Software Update (TV5 shown)



Corrective Maintenance

If a system component fails, it will need to be replaced by a KVH-certified technician. Instructions are provided with the replacement part.

Important!

Field replaceable units should only be replaced by a trained, KVH-certified technician. To find a technician near you, visit www.kvh.com/wheretogetservice or contact KVH Technical Support (see "Technical Support" on page 100).

SVIB

Restarting the System

If you experience a problem with the system, you may need to restart the hardware. You can restart the following system components at the web interface (go to Support > Restart System).

- **Restart Antenna:** Restarts the TracVision antenna. Choose this option whenever the antenna is unable to find the satellite.
- **Restart All:** Restarts both the TV-Hub and the antenna. Choose this option if the problem cannot be isolated to the antenna.

Figure 9-4 Restart System Menu

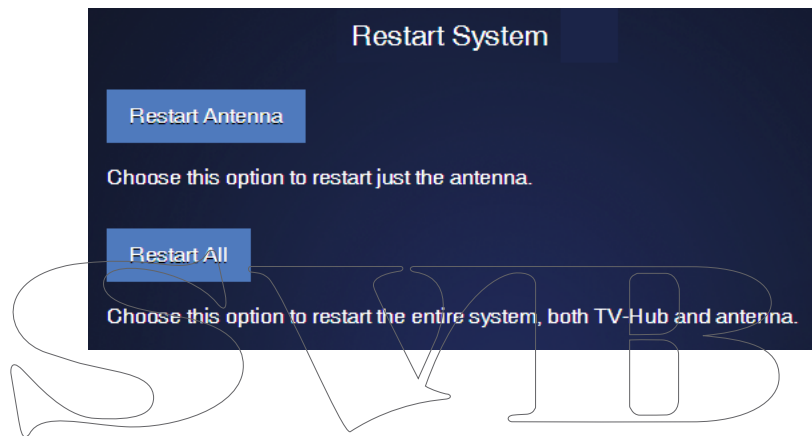



Appendix

A. Specifications

This section provides the technical specifications of the TracVision system's components.

Contents

System Specifications 113

SVIB

A

System Specifications

NOTE: All specifications are subject to change without notice.

TracVision TV5 Antenna Specifications

Attribute	Rating
Meets Inmarsat BGAN operational, survival, vibration, and shock specifications	
Dimensions	19.2" (48.8 cm) OD x 20.9" (53.2 cm) H
Weight	25 lbs (11.3 kg)
Temperature	Operating: -13°F to +131°F (-25°C to 55°C) Survival: -13°F to +158°F (-25°C to +70°C)
Input power	42 VDC (from TV-Hub), 53 W nominal
Minimum EIRP	48 dBW (Ku-band)
Frequency range	10.7 to 12.75 GHz
Polarizations	<ul style="list-style-type: none"> • Vertical/horizontal polarity, high/low band • Simultaneous LHCP (left-hand circular polarization) and RHCP (right-hand circular polarization)
LNB options	<ul style="list-style-type: none"> • Linear Universal Quad • DIRECTV L.A. Circular • Circular • Tri-Americas Circular
Elevation range	0° to 80°
Azimuth range	720°
Skew control	Manual or Automatic
Cable connections	75-ohm type "F" connector

TV-Hub Specifications

Attribute	Rating
Meets Inmarsat operational, survival, and shock specifications	
Dimensions	11.2" (28.5 cm) W x 8.5" (21.6 cm) D x 2.8" (7.1 cm) H
Weight	10 lbs (4.5 kg)
Temperature	Operating: 5°F to +131°F (-15°C to 55°C) Survival: 5°F to +158°F (-15°C to +70°C)
Input voltage	12 VDC or 24 VDC (10-30 VDC required at TV-Hub), 10 A max current
Output voltage	42 VDC
Supported RF1 cable to antenna	Up to 100 ft (30 m): RG-6 Up to 200 ft (60 m): RG-11
Supported NMEA messages	NMEA 0183 (4800 baud): \$--HDG, HDM, HDT, OSD, THS, VHW, RMC NMEA 2000: PGN 127250, PGN 129029

S V I D

SVIB



www.kvh.com



KVH Industries A/S
EMEA Headquarters
Kokkedal, Denmark
Tel: +45 45 160 180 Fax: +45 45 160 181
E-mail: info@emea.kvh.com

KVH Industries, Inc.
World Headquarters
Middletown, RI U.S.A.
Tel: +1 401 847 3327 Fax: +1 401 849 0045
E-mail: info@kvh.com

KVH Industries Pte Ltd.
Asia-Pacific Headquarters
Singapore
Tel: +65 6513 0290 Fax: +65 6472 3469
E-mail: info@apac.kvh.com