

STANDARD HORIZON

Nothing takes to water like Standard Horizon

HX870

6 Watt VHF/FM

Floating Class D DSC Marine Transceiver with GPS

Owner's Manual



TABLE OF CONTENTS

Quick Reference Guide.....	4	10.2 MARITIME MOBILE SERVICE IDENTITY (MMSI).....	38
Introduction.....	5	10.2.1 What is an MMSI?.....	38
1 GENERAL INFORMATION.....	6	10.2.2 Programming the MMSI.....	39
2 PACKING LIST.....	6	10.3 DSC DISTRESS CALL.....	40
3 OPTIONAL ACCESSORIES.....	7	10.3.1 Transmitting a DSC Distress Call.....	40
4 ONLINE WARRANTY REGISTRATION (in USA or Canada only).....	8	10.3.2 Receiving a DSC Distress Call.....	42
5 ABOUT THIS RADIO.....	9	10.4 ALL SHIPS CALL.....	44
5.1 PROHIBITED COMMUNICATIONS.....	9	10.4.1 Transmitting an All Ships Call.....	44
5.2 ABOUT VHF RADIO.....	9	10.4.2 Receiving an All Ships Call.....	45
5.3 DISTRESS AND HAILING (CHANNEL 16).....	9	10.5 INDIVIDUAL CALL.....	46
5.4 CALLING ANOTHER VESSEL (CHANNEL 16 OR 9).....	10	10.5.1 Setting up the Individual / Position Call Directory.....	46
5.5 MAKING TELEPHONE CALLS.....	11	10.5.2 Setting up the Individual Call Reply.....	47
5.6 BRIDGE CHANNELS 13 AND 67.....	11	10.5.3 Enabling the Individual Call Acknowledgment.....	48
5.7 AUTOMATED RADIO CHECK SERVICE.....	12	10.5.4 Transmitting an Individual Call.....	48
6 GETTING STARTED.....	13	10.5.5 Receiving an Individual Call.....	50
6.1 BATTERIES AND CHARGERS.....	13	10.5.6 Setting up the Individual Call Ringer.....	52
6.1.1 Battery Safety.....	13	10.6 GROUP CALL.....	53
6.1.2 Rechargeable Battery Installation/Removal.....	15	10.6.1 Setting up a Group Call.....	53
6.1.3 Battery Life Information.....	15	10.6.2 Transmitting a Group Call.....	55
6.1.4 Using the SBH-12 Charger Cradle.....	16	10.6.3 Receiving a Group Call.....	57
6.1.5 Installation of the SBT-13 Battery Case.....	17	10.6.4 Setting up the Group Call Ringer.....	58
6.2 BELT CLIP INSTALLATION / REMOVAL.....	18	10.7 POSITION REQUEST.....	59
6.3 ATTACHING AN ANTENNA.....	18	10.7.1 Transmitting a Position Request to Another Vessel.....	59
6.4 CHECKING GPS SIGNAL (GPS STATUS DISPLAY).....	19	10.7.2 Receiving a Position Request.....	61
6.5 CHANGING THE GPS TIME.....	20	10.7.3 Manual Input of Position Information.....	61
6.6 CHANGING THE TIME LOCATION.....	21	10.7.4 Setting up a Position Request Ringer.....	62
6.7 CHANGING THE TIME FORMAT.....	21	10.8 POSITION REPORT.....	63
7 CONTROLS AND INDICATORS.....	22	10.8.1 Transmitting a DSC Position Report Call.....	63
8 BASIC OPERATION.....	25	10.8.2 Receiving a DSC Position Report Call.....	65
8.1 TURNING ON AND OFF THE TRANSCEIVER.....	25	10.8.3 Navigating to the Reported Position.....	65
8.2 RECEPTION.....	25	10.8.4 Saving the Reported Position as a Waypoint.....	66
8.3 TRANSMISSION.....	25	10.8.5 Setting up a Position Report Ringer.....	67
8.3.1 Transmit Power.....	26	10.9 POLLING CALL.....	68
8.4 TRANSMIT TIME-OUT TIMER (TOT).....	26	10.9.1 Transmitting a Polling Call to a Vessel.....	68
8.5 SIMPLEX/DUPLEX CHANNEL USE.....	27	10.9.2 Receiving a Polling Call.....	69
8.6 USA, INTERNATIONAL, AND CANADA MODE.....	27	10.10 AUTO POS POLLING.....	70
8.7 NOAA WEATHER CHANNELS.....	27	10.10.1 Setting up the Polling Operation.....	70
8.7.1 NOAA Weather Alert.....	28	10.10.2 Setting up the Polling Time Interval.....	70
8.7.2 NOAA Weather Alert Testing.....	28	10.10.3 Selecting Vessels to be Automatically Polled.....	71
8.8 MULTI WATCH (TO PRIORITY CHANNEL).....	29	10.10.4 Enabling/Disabling Auto POS Polling.....	72
8.8.1 Setting up the Multi Watch Operation.....	29	10.11 DSC TEST.....	73
8.8.2 Starting the Dual Watch.....	29	10.11.1 Programming MMSI into Individual Directory.....	73
8.9 SCANNING.....	30	10.11.2 Transmitting a DSC Test to Another Vessel.....	73
8.9.1 Selecting the Scan Type.....	30	10.11.3 Receiving a DSC Test Call.....	74
8.9.2 Programming Scan Memory.....	31	10.12 DSC LOG OPERATION.....	75
8.9.3 Memory Scanning (M-SCAN).....	31	10.12.1 Reviewing and Resending a Transmitted Logged Call.....	75
8.9.4 Priority Scanning (P-SCAN).....	32	10.12.2 Reviewing a Logged DSC Distress Call.....	76
8.10 PRESET CHANNELS: INSTANT ACCESS.....	32	10.12.3 Reviewing Other Logged Calls.....	76
8.10.1 Programming.....	32	10.12.4 Deleting Logged Calls from the DSC Log Directory.....	77
8.10.2 Operation.....	33	10.13 DSC LOOP BACK OPERATION.....	78
8.10.3 Deletion.....	33	11 NAVIGATION.....	79
8.11 MOB OPERATION.....	34	11.1 WAYPOINT OPERATION.....	79
8.12 VOX OPERATION.....	34	11.1.1 Starting and Stopping Navigation.....	79
8.13 OPERATION MENU.....	35	11.1.2 Setting Up Waypoint Directory.....	81
9 GPS OPERATION.....	36	11.1.3 Selecting the Display Range.....	85
9.1 DISPLAYING POSITION INFORMATION.....	36	11.1.4 Selecting the Arrival Range.....	85
9.1.1 GPS Information Compass Display.....	36	11.2 ROUTING OPERATION.....	86
9.1.2 GPS Information Numerical Display.....	36	11.2.1 Setting Up Routing Directory.....	86
9.2 CHECKING GPS STATUS.....	37	11.2.2 Starting and Stopping Route Navigation.....	88
9.3 GPS LOGGER OPERATION.....	37	11.2.3 Changing the Destination.....	89
10 DIGITAL SELECTIVE CALLING (DSC).....	38	11.2.4 Selecting Automatic or Manual Routing.....	89
10.1 GENERAL.....	38		

QUICK REFERENCE GUIDE

The **HX870** is equipped with the E2O (Easy-To-Operate) menu system. Basic operation may be accomplished by following the procedure below:

- ① **⏻**: Press and hold to turn on/off the transceiver.
- ② **PTT** (Push-To-Talk): Activates the transmitter when pressed.
- ③ **SQL**: Press to display the SQL level setting screen, then press the **CH▲** key to squelch or press the **CH▼** to un-squelch the radio.
- ④ **MIC**: Speak slowly and clearly into the **MIC** hole having it about 1/2 to 1 inch (1.2 to 2.5 cm) away from your mouth while pressing the **PTT** key.
- ⑤ **◀/▶**: Press to toggle the on-screen menus to right/left.
- ⑥ **CLR**: Press to cancel a function or menu selection.
- ⑦ **MENU**: Press to access MENU.
- ⑧ **DISTRESS**: Activates a DSC distress call. Lift the red cover, press the **DISTRESS** once, then press and hold until the radio alarms.
- ⑨ **Soft keys**: These three programmable keys can be customized through the setup menu mode. By pressing one of these keys briefly, display the key functions at the bottom of the display.
- ⑩ **Strobe Light**: Blinks the internationally-recognized Morse Code "S.O.S" message by pressing the **[STROBE]** soft key.
- ⑪ **CH▼/CH▲**: Press to change the operating channel.
- ⑫ **⏻**: Press and hold to lock and unlock the keypad.
- ⑬ **16/S**: Press to recall channel 16. Press and hold to recall the sub channel.
- ⑭ **VOL-/VOL+**: Press to adjust the speaker audio volume.



INTRODUCTION

Congratulations on your purchase of the **HX870**! Whether this is your first portable marine VHF transceiver, or if you have other STANDARD HORIZON* equipment, the STANDARD HORIZON organization is committed to ensuring your enjoyment of this high performance transceiver, which should provide you with many years of satisfying communications even in the harshest of environments. STANDARD HORIZON technical support personnel stand behind every product sold, and we invite you to contact us by phone (800) 767-2450.

We appreciate your purchase of the **HX870**, and encourage you to read this manual thoroughly, so as to learn and fully understand the capabilities of the **HX870**.

※: Marine Division of YAESU USA

RADIO CARE

Before using the radio:

1. It is recommended to fully charge the battery. See section “**6.1.4 Using the SBH-12 Charger Cradle**” for details.
2. Be sure that the speaker microphone cap, antenna and battery are in place and firmly tightened.
3. Care must be taken if the radio was dropped and a close inspection may be needed to insure the radio case and gaskets are in adequate condition.

NOTE

To keep the LCD, keypad and speaker grill clean and in top operating condition after exposure to water: Clean the radio with fresh water after exposure to salt water by rinsing the radio under a sink faucet or by dunking the radio in a bucket of fresh water. After washing, use a soft cloth and thoroughly dry all parts of the radio.

1 GENERAL INFORMATION

The STANDARD HORIZON **HX870** Portable Marine transceiver is designed to be used in USA, International, and Canadian Marine bands. The **HX870** can be operated from 11 to 16 VDC and has a switchable RF output power of 1 watt, 2 watts or 6 watts.

The **HX870** is capable of DSC (Digital Selective Calling) ITU-R M.493 Class D operation. Class D operation allows continuous receiving of Digital Selective Calling functions on channel 70 even if the radio is receiving a call. The **HX870** operates on all currently-allocated marine channels which are switchable for use with USA, International, or Canadian regulations. Emergency channel 16 can be immediately selected from any channel by pressing the red **16/S** key. NOAA weather channel can also be accessed immediately by pressing the **[WX]** soft key.

With the internal high-performance 66 Channel GPS receiver, WAAS and QZSS satellites can be received.

2 PACKING LIST

When the package containing the transceiver is first opened, please check it for the following contents:

- **HX870** Transceiver
- **CAT460** Antenna
- **SBR-13LI** 7.4V 1800mAh Li-ion Battery Pack
- **SBH-12** Charger Cradle for **HX870**
- **SAD-11B** 120VAC Wall Charger for **SBH-12**
- **E-DC-19A** DC Cable with 12 V Cigarette Lighter Plug for **SBH-12**
- **SBT-13** Alkaline Battery Case for AAA x 5
- **Clip-22** Belt Clip
- **YS-05-01** Hand Strap
- **T9101606** USB Cable (Type USB "A" plug to Type USB mini "B" plug)
- Owner's Manual

3 OPTIONAL ACCESSORIES

- ① **MH-73A4B** Submersible Speaker/Microphone
 - ② **MH-57A4B** Mini Speaker/Microphone
 - ③ **SSM-14A** Submersible Speaker/Microphone with Earphone Jack
 - ④ **SEP-10** Earphone for SSM-14A
 - ⑤ **VC-24** VOX Headset
 - ⑥ **SSM-55A** Earpiece/Microphone
 - ⑦ **CN-3** Radio-to-Ship's-Antenna Adapter
 - ⑧ **SBR-13 LI** 7.4V 1800mAh Li-ion Battery Pack
 - ⑨ **SBT-13** Alkaline Battery Case (AAA x 5 pcs)
 - ⑩ **SBH-12** Charger Cradle
 - ⑪ **E-DC-19A** DC Cable with 12 V Cigarette Lighter Plug
 - ⑫ **SAD-11B/C/U*** Wall Charger for the **SBH-12**
 - ⑬ **E-DC-6** DC Cable; plug and wire only
- ※: "B" suffix is for use with 120 VAC (Type-A plug), "C" suffix is for use with 230 VAC (Type-C plug), and "U" suffix is for use with 230 VAC (Type-BF plug).

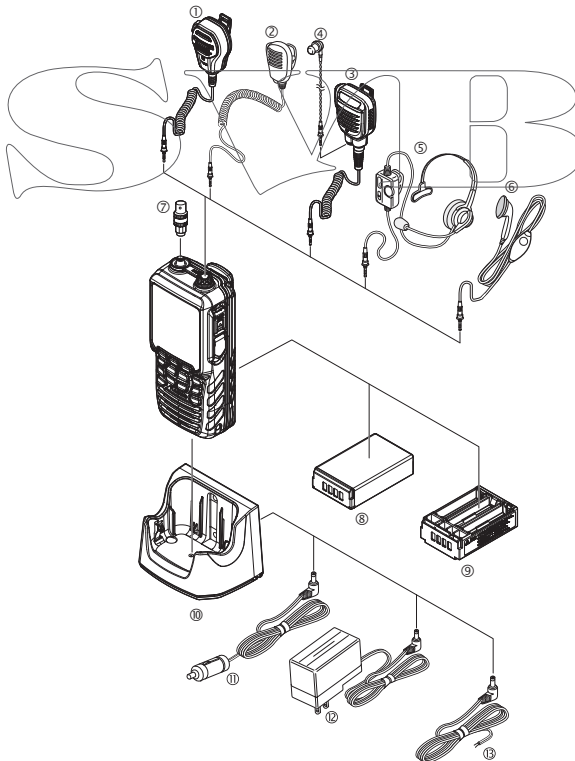

4 ONLINE WARRANTY REGISTRATION (in USA or Canada only)

Please visit www.standardhorizon.com to register the **HX870** Marine VHF. It should be noted that visiting the website from time to time may be beneficial to you, as new products are released they will appear on the STANDARD HORIZON website.

PRODUCT SUPPORT INQUIRIES

If you have any questions or comments regarding the use of the **HX870**, you can visit the STANDARD HORIZON website to send an E-Mail or contact the Product Support team at (800) 767-2450 M-F 8:00-5:00 PST.

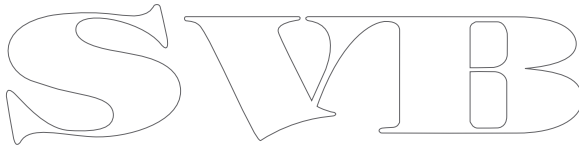

5 ABOUT THIS RADIO

5.1 PROHIBITED COMMUNICATIONS

The FCC prohibits the following communications:

- False distress or emergency messages;
- Messages to “any boat” except in emergencies and radio tests;
- Messages to or from a vessel on land;
- Transmission while on land;
- Obscene, indecent, or profane language (potential fine of \$10,000).

5.2 ABOUT VHF RADIO

The radio frequencies used in the VHF marine band lie between 156 and 158 MHz with some shore stations available between 161 and 163 MHz. The marine VHF band provides communications over distances that are essentially “line of sight” (VHF signals do not travel well through objects such as buildings, hills or trees). Actual transmission range depends much more on antenna type, gain and height than on the power output of the transmitter. On a fixed mount 25W radio transmission expected distances can be greater than 15 miles, for a portable 6W radio transmission the expected distance can be greater than 5 miles in “line of sight”.

5.3 DISTRESS AND HAILING (CHANNEL 16)

Channel 16 is known as the Hail and Distress Channel. An emergency may be defined as a threat to life or property. In such instances, be sure the transceiver is on and set to CHANNEL 16. Then use the following procedure:

1. Press the **PTT** (Push-To-Talk) button and say “**Mayday, Mayday, Mayday**. This is _____, _____, _____” (your vessel’s name).
2. Then repeat once: “**Mayday, _____**” (your vessel’s name).
3. Now report your position in latitude/longitude, or by giving a true or magnetic bearing (state which) to a well-known landmark such as a navigation aid or geographic feature such as an island or harbor entry.
4. Explain the nature of your distress (sinking, collision, aground, fire, heart attack, life-threatening injury, etc.).
5. State the kind of assistance your desire (pumps, medical aid, etc.).
6. Report the number of persons aboard and condition of any injured.
7. Estimate the present seaworthiness and condition of your vessel.
8. Give your vessel’s description: length, design (power or sail), color and other distinguishing marks. The total transmission should not exceed 1 minute.
9. End the message by saying “**OVER**”. Release the **PTT** button and listen.
10. If there is no answer, repeat the above procedure. If there is still no response, try another channel.

NOTE

The **HX870** has the DSC Distress calling, that can transmit a distress call digitally to all ships with compatible DSC radios. Refer to section “**10 DIGITAL SELECTIVE CALLING (DSC)**”.

5.4 CALLING ANOTHER VESSEL (CHANNEL 16 OR 9)

Channel 16 may be used for initial contact (hailing) with another vessel. However, its most important use is for emergency messages. This channel must be monitored at all times except when actually using another channel.

It is monitored by the U.S. and Canadian Coast Guards and by other vessels. **Use of channel 16 for hailing must be limited to initial contact only.** Calling should not exceed 30 seconds, but may be repeated 3 times at 2-minute intervals. In areas of heavy radio traffic, congestion on channel 16 resulting from its use as a hailing channel can be reduced significantly in U.S. waters by using **channel 9** as the initial contact (hailing) channel for non-emergency communications. Here, also, calling time should not exceed 30 seconds but may be repeated 3 times at 2-minute intervals.

Prior to making contact with another vessel, refer to the channel charts in this manual, and select an appropriate channel for communications after initial contact. For example, Channels 68 and 69 of the U.S. VHF Charts are some of the channels available to non-commercial (recreational) boaters. Monitor your desired channel in advance to make sure you will not be interrupting other traffic, and then go back to either channel 16 or 9 for your initial contact.

When the hailing channel (16 or 9) is clear, press the **PTT** button and state the name of the other vessel you wish to call and then “**this is**” followed by the name of your vessel and your Station License (Call Sign) then release the **PTT** button. When the other vessel returns your call, immediately request another channel by pressing the **PTT** button and saying “**go to**”, the number of the other channel, say “**over**” and release the **PTT** button. Then switch to the new channel. When the new channel is not busy, call the other vessel.

After a transmission, say “**over**”, and release the **PTT** button. When all communication with the other vessel is completed, end the last transmission by stating your Call Sign and the word “**out**”. Note that it is not necessary to state your Call Sign with each transmission, only at the beginning and end of the contact.

Remember to return to Channel 16 when not using another channel. Some radios automatically monitor Channel 16 even when set to other channels or when scanning.

5.5 MAKING TELEPHONE CALLS

To make a radiotelephone call, use a channel designated for this purpose. The fastest way to learn which channels are used for radiotelephone traffic is to ask at a local marina. Channels available for such traffic are designated **Public Correspondence** channels on the channel charts in this manual. Some examples for USA use are Channels 24, 25, 26, 27, 28, 84, 85, 86, and 87. Call the marine operator and identify yourself by your vessel's name. The marine operator will then ask you how you will pay for the call (telephone credit card, collect, etc.) and then link your radio transmission to the telephone lines.

The marine telephone company managing the VHF channel you are using may charge a link-up fee in addition to the cost of the call.

5.6 BRIDGE CHANNELS 13 AND 67

Channel 13 is used at docks, bridges and by vessels maneuvering in port. Messages on this channel must concern navigation only, such as meeting and passing in restricted waters.

Channel 67 is used for navigational traffic between vessels.

By regulation, power is normally limited to 1 Watt on these channels. Your radio is programmed to automatically reduce power to this limit on these channels. However, in certain situations it may be necessary to temporarily use a higher power. See Page 26 for means to temporarily override the low-power limit on these two channels.

5.7 AUTOMATED RADIO CHECK SERVICE

In areas across the country, Sea Tow offers boaters a way to conduct radio checks. To use Sea Tow's free Automated Radio Check service, simply tune your VHF radio to the appropriate channel for your location and conduct a radio check as you typically would. Upon releasing your radio's microphone, the system will play an automated message and relay your transmission back to you, thereby letting you know how your signal will sound to other boaters.

The Automated Radio Check Service is currently available in the areas listed below.

- West Coast** Sea Tow Newport/LA - Ch. 27
Sea Tow San Diego - Ch. 27
- Northeast** Sea Tow Portland-Midcoast (Maine) - Ch. 27
Sea Tow Boston - Ch. 27
Sea Tow South Shore (Mass.) - Ch. 28
Sea Tow Rhode Island - Ch. 24
Sea Tow Eastern Long Island - Ch. 27
Sea Tow Huntington (N.Y.) - Ch. 27
Sea Tow Manasquan (N.J.) - Ch. 28
- Mid-Atlantic** Sea Tow Northern Chesapeake (Md.) - Ch. 28
Sea Tow Central Chesapeake (Md.) - Ch. 27
Sea Tow Hampton Roads (Va.) - Ch. 28
- North Carolina** Sea Tow Wrightsville Beach - Ch. 28
Sea Tow Ocean Isle Beach - Ch. 28
- Florida** Sea Tow Sebastian - Ch. 28
Sea Tow Fort Lauderdale - Ch. 27
Sea Tow Charlotte Harbor - Ch. 24
Sea Tow Tampa Bay - Ch. 27
Sea Tow Horseshoe Beach - Ch. 27
Sea Tow Carrabelle/St. Marks - Ch. 27
Sea Tow Pensacola/Orange Beach (Ala.) - Ch. 27

6 GETTING STARTED

NOTE

Water resistance of the transceiver is assured only when the battery cover is attached to the transceiver, **DATA** jack cover is locked and **MIC/SP** cap is installed in the **MIC/SP** jack.

6.1 BATTERIES AND CHARGERS

If the radio has never been used, or its charge is depleted, it may be charged by connecting the **SBH-12** Charger Cradle with the **SAD-11B** battery charger, as shown in the illustration. If 12V DC power is available, the **E-DC-19A** DC Cable with 12 V Cigarette Lighter Plug or the optional **E-DC-6** DC Cable may be used for charging the battery. The **SAD-11B**, **E-DC-19A** and **E-DC-6** will charge a completely discharged **SBR-13LI** battery pack in about 3 hours.

The **SBR-13LI** is a high performance Li-ion battery providing high capacity in a compact package.

SBR-13LI Rechargeable Battery Pack

Capacity	1800 mAh			
Nominal Voltage	7.4V			
Temperature Range	Minimum		Maximum	
	°C	°F	°C	°F
Charge	5	41	35	95
Discharge	-20	-4	60	140
Storage	-10	14	35	95

CAUTION

To avoid risk of explosion and injury, **SBR-13LI** battery pack should only be removed, charged or recharged in non-hazardous environments.

6.1.1 Battery Safety

Battery packs for your transceiver contain Li-ion batteries. This type of battery stores a charge powerful enough to be dangerous if misused or abused, especially when removed from the transceiver. Please observe the following precautions:

DO NOT SHORT BATTERY PACK TERMINALS: Shorting the terminals that power the transceiver can cause sparks, severe overheating, burns, and battery cell damage. If the short is of sufficient duration, it is possible to melt battery components. Do not place a loose battery pack on or near metal surfaces or

objects such as paper clips, keys, tools, etc. When the battery pack is installed on the transceiver, the terminals that transfer current to the transceiver are not exposed. The terminals that are exposed on the battery pack when it is mounted on the transceiver are charging terminals only and do not constitute a hazard.

DO NOT INCINERATE: Do not dispose of any battery in a fire or incinerator. The heat of fire may cause battery cells to explode and/or release dangerous gases.

Battery Maintenance

For safe and proper battery use, please observe the following:

- Battery packs should be charged only in non-hazardous environments.
- Use only STANDARD HORIZON-approved batteries.
- Use only a STANDARD HORIZON-approved charger. The use of any other charger may cause permanent damage to the battery.
- Follow charging instructions provided with the chargers.
- Keep the battery contacts clean.

Battery Storage

Store the batteries in a cool place to maximize storage life. Since batteries are subject to self-discharge, avoid high storage temperatures that cause large self-discharge rates. After extended storage, a full recharge is recommended.

Battery Recycling

**DO NOT PLACE USED BATTERIES IN YOUR REGULAR TRASH!
LI-ION BATTERIES MUST BE COLLECTED, RECYCLED OR DISPOSED
OF IN AN ENVIRONMENTALLY SOUND MANNER.**

The incineration, land filling or mixing of Li-ion batteries with the municipal solid waste stream is PROHIBITED BY LAW in most areas.

Return batteries to an approved Li-ion battery recycler. This may be where you purchased the battery.

Contact your local waste management officials for other information regarding the environmentally sound collection, recycling and disposal of Li-ion batteries.



Li-ion

6.1.2 Rechargeable Battery Installation/Removal

1. Turn the transceiver off.
2. Slide the battery cover lock switch to the **“UNLOCK”** position, then press **“PUSH”** to open the battery cover.

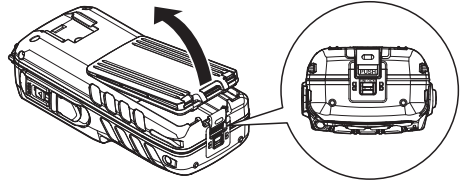

3. Install the **SBR-13LI** battery pack into the battery rest aligning it to the battery contacts until it clicks.
4. Attach the battery cover, then slide the battery cover lock switch to the **“LOCK”** position.

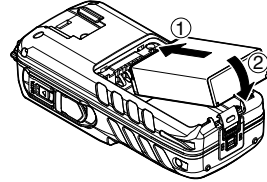

To remove the battery pack, turn the transceiver off, open the battery cover, then push and lift up the bottom end of the battery pack.

NOTE

The battery lock must be set to **“LOCK”** position to ensure water integrity and keep the battery from coming loose.

6.1.3 Battery Life Information

When the battery charge is almost depleted, a **“”** icon will appear on the display. When the **“”** icon appears, it is recommended that you charge the battery soon.

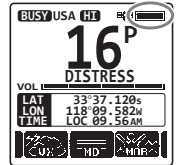

	: Full battery power
	: Enough battery power
	: Low battery power
	: Poor battery power
	: Charge (or replace) the battery

6.1.4 Using the SBH-12 Charger Cradle

1. Insert the DC plug from the **SAD-11B** into the DC jack at the bottom of the **SBH-12**.
Put the wire of the **SAD-11B** into either of the left or right hook at the bottom of the **SBH-12**.

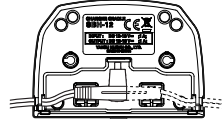
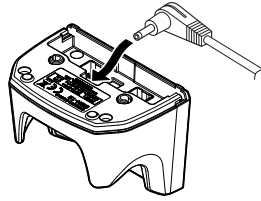

2. Plug the **SAD-11B** into the AC line outlet.
3. Insert the **HX870** (with the battery pack) into the **SBH-12**; the antenna should be at the left side when viewing the charger from the front.

If the HX870 is inserted correctly, the HX870's LCD display will show the battery charging icon. A fully-discharged pack will be charged completely in approximately 3 hours.

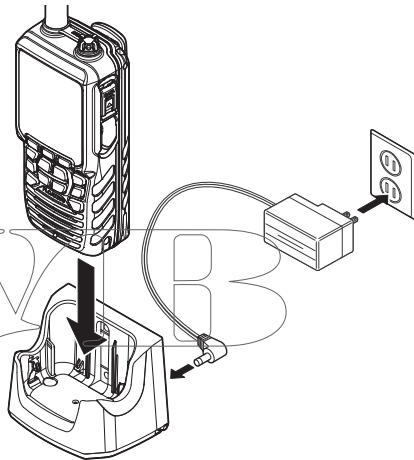

When charging is completed, the battery charging icon will disappear.

CAUTION

The **SBH-12** is NOT designed to be waterproof. Charge the radio in a dry location.

NOTE

The **SBH-12** is only designed for the charging of the **HX870**'s battery, and is not suitable for other purposes. The **SBH-12** may contribute noise to TV and radio reception in the immediate vicinity, so we do not recommend its use adjacent to such devices.

6.1.5 Installation of the SBT-13 Battery Case

The **SBT-13** is a battery case that holds five “AAA” size Alkaline batteries and is used with the **HX870** transceiver. The Alkaline batteries can be used for reception and transmission in an emergency, and battery life will be shortened dramatically.

1. Turn the transceiver off.
2. Slide the five “AAA” size Alkaline batteries into the **SBT-13** with the Negative (–) side of the batteries touching the spring connections inside the **SBT-13**.

Put three batteries into the compartment on the front side and two on the back side.

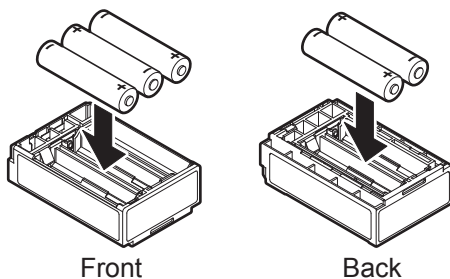

3. Slide the battery cover lock switch to the “**UNLOCK**” position, then press “**PUSH**” to open the battery cover.

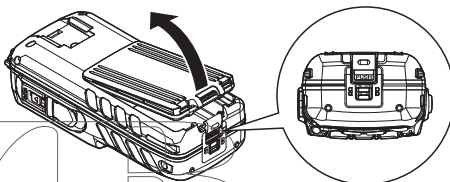

4. Install the **SBT-13** into the battery rest aligning it to the battery contacts until it clicks.

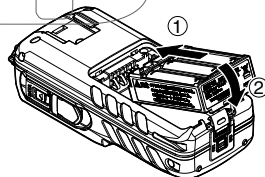

5. Attach the battery cover, then slide the battery cover lock switch to the “**LOCK**” position.

To remove the battery case, turn the transceiver off, open the battery cover, then push and lift up the bottom end of the battery case.

NOTE

- When the **SBT-13** Alkaline Battery Case is used, the **HX870** transmit output is fixed to 1 W.
- The **HX870** will float with the **SBT-13** attached.

6.2 BELT CLIP INSTALLATION / REMOVAL

1. To install, align the Belt Clip **Clip-22** to the groove of the Battery pack, then press the Belt Clip downward until it locks in place with a “Click”.
2. To remove, pull the **Clip-22** tab away from the battery pack to unlock the **Clip-22**, then slide the **Clip-22** upward to remove it.

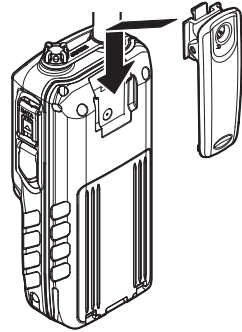

6.3 ATTACHING AN ANTENNA

Insert the **CAT460** antenna into the **ANT** jack at the top panel, hold the bottom end of the antenna, then screw it onto the mating connector on the transceiver until it is snug. Do not over-tighten.

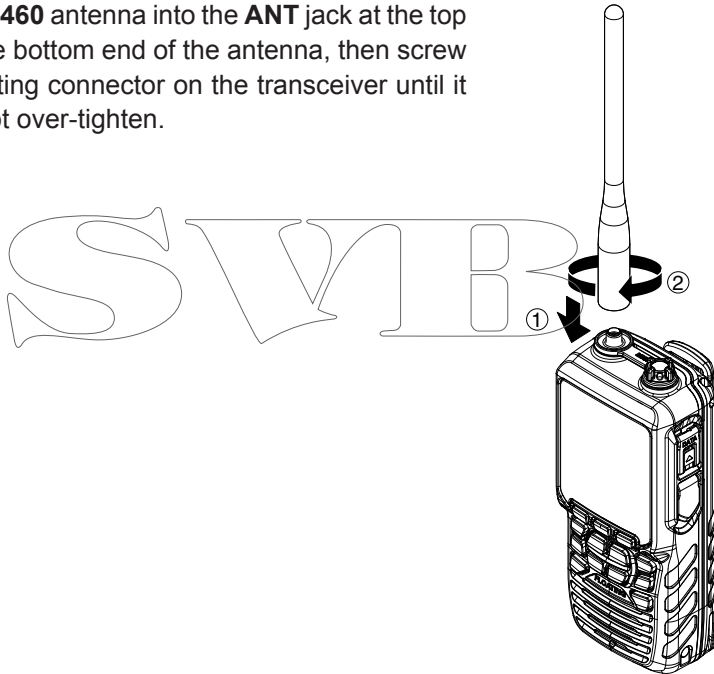

6.4 CHECKING GPS SIGNAL (GPS STATUS DISPLAY)

When the **HX870** receives the GPS signal, a small satellite icon “” will appear on the display and your current location (latitude/longitude) is shown on the display.

The **HX870** has a GPS status display which shows the satellites currently being received, along with a graphical (bar-graph) representation of the relative signal strengths from the satellites.

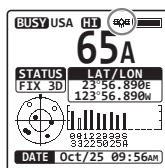

(GPS STATUS DISPLAY MODE)

1. Press and hold the **POWER** key on the left side of the transceiver to turn it on.
2. Press the **MENU** key to display “MENU”, then select “GPS” with the **CH▼/CH▲/◀/▶** key.
3. Press the **[SELECT]** soft key, then select “GPS STATUS” with the **CH▼/CH▲** key.
4. Press the **[ENTER]** soft key to display the GPS status currently being received.
5. Press the **CLR** key to return to radio operation.

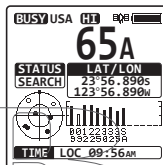
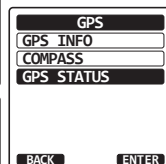
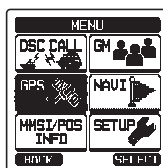

NOTE

- When the **HX870** is first turned on, it may take several minutes to compute a fix of your position. This is normal, as the **HX870** is downloading “almanac” information from the GPS satellites.
- When using the **HX870** inside of a cabin where GPS reception is limited, choose a place where GPS satellite reception is good enough referring to the GPS status display.

6.5 CHANGING THE GPS TIME

From the factory the **HX870** shows GPS satellite time or UTC (Universal Time Coordinated) time. A time offset is needed to show the local time in your area. The time offset must be changed in order for the radio to display the current time in your area. See the Offset Time Table below.

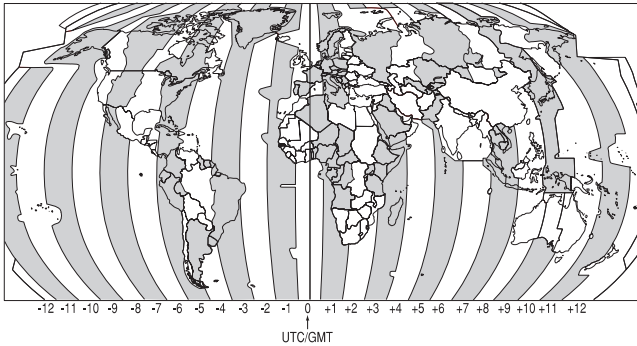

OFFSET TIME TABLE

1. Press the **MENU** key to display “MENU”, then select “SETUP” with the **CH▼/CH▲/◀/▶** key.
2. Select “GPS SETUP” with the **CH▼/CH▲** key.
3. Press the **[SELECT]** soft key, then select “TIME OFFSET” with the **CH▼/CH▲** key.
4. Press the **[SELECT]** soft key, then press the **CH▼/CH▲** key to select time offset of your location. See illustration above to find your offset time. If “00:00” is assigned, the time is the same as UTC or GPS satellite time.
5. Press the **[ENTER]** soft key to store the time offset.
6. Press the **CLR** key to return to radio operation.

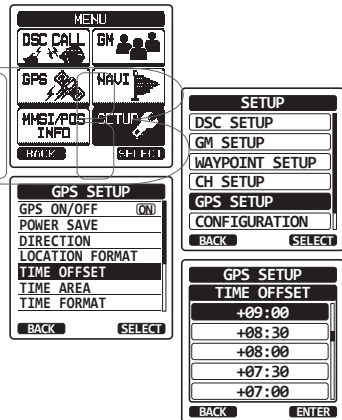

6.6 CHANGING THE TIME LOCATION

This menu selection allows the radio to show UTC time or local time with offset.

1. Press the **MENU** key to display “MENU”, then select “SETUP” with the **CH▼/CH▲/◀/▶** key.
2. Press the **[SELECT]** soft key, then select “GPS SETUP” with the **CH▼/CH▲** key.
3. Press the **[SELECT]** soft key, then press the **CH▼/CH▲** key to “TIME AREA”.
4. Press the **[SELECT]** soft key.
5. Press the **CH▼/CH▲** key to select “UTC” or “LOCAL”.
6. Press the **[ENTER]** soft key to store the selected setting.
7. Press the **CLR** key to return to radio operation.

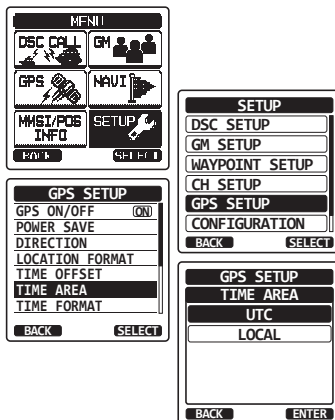

6.7 CHANGING THE TIME FORMAT

This menu selection allows the radio to setup to show time in 12-hour or 24-hour format.

1. Press the **MENU** key to display “MENU”, then select “SETUP” with the **CH▼/CH▲/◀/▶** key.
2. Press the **[SELECT]** soft key, then select “GPS SETUP” with the **CH▼/CH▲** key.
3. Press the **[SELECT]** soft key, then press the **CH▼/CH▲** key to select “TIME FORMAT”.
4. Press the **[SELECT]** soft key.
5. Press the **CH▼/CH▲** key to select “12hour” or “24hour”.
6. Press the **[ENTER]** soft key to store the selected setting.
7. Press the **CLR** key to return to radio operation.

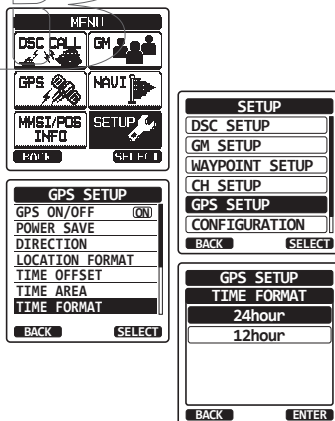

7 CONTROLS AND INDICATORS

This section defines each control of the transceiver. See illustration below for location of controls. For detailed operating instructions refer to chapter 8 of this manual.

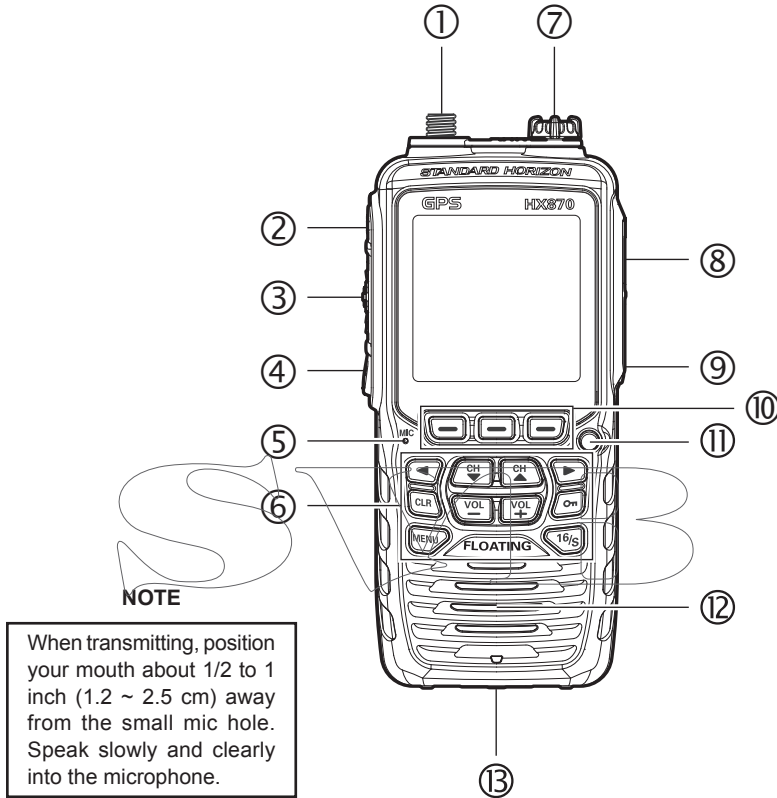

① **ANT** jack (Top side)

The supplied **CAT460** flexible antenna is attached here.

② **⏻** (Power) switch (Left side)

Press and hold to toggle the radio on or off.

③ **PTT** (Push-To-Talk) button (Left side)

When pushed activates the transmitter.

④ **SQL** switch (Left side)

Press this key to activate the squelch adjusting mode. Press the **CH▲** or **CH▼** key to adjust the squelch threshold level.

Press and hold the squelch key for 3 seconds to open the squelch, allowing you to monitor the operating channel. Press this key to resume normal (quiet) monitoring.

⑤ **MIC** hole

The internal microphone is located here.

NOTE

When transmitting, position your mouth about 1/2 to 1 inch (1.2 ~ 2.5 cm) away from the small mic hole. Speak slowly and clearly into the microphone.

⑥ Keypad

MENU key

Press to access MENU.

CH▲ key

This key is used to change the operating channel and squelch threshold level.

Press the key momentarily, the channel (or level) increases one step. Holding the key, the channel (or level) increases continuously.

CH▼ key

This key is used to change the operating channel and squelch threshold level.

Press the key momentarily, the channel (or level) decreases one step. Holding the key, the channel (or level) decreases continuously.

On key

Hold down this key to lock the keypad so that they are not accidentally changed. “**LOCK**” will appear on the entire screen, to indicate that the functions are locked. Hold down this key until “**UNLOCK**” appears to unlock the radio.

◀/▶ key

Press to toggle the on-screen menus to right/left.

VOL+ key

Press to increase the speaker audio volume level.

VOL- key

Press to decrease the speaker audio volume level.

16/S key

Pressing this key immediately recalls channel 16 from any channel location. Holding down this key recalls the SUB channel (The default setting is channel 9). Pressing this key again reverts to the previous selected working channel.

CLR key

Press this key to cancel a menu selection and/or keypad entry.

⑦ **MIC/SP** jack (Top side)

The jack accepts the optional **MH-73A4B** Submersible Speaker/Microphone, **MH-57A4B** Mini Speaker/Microphone, **VC-24** VOX Headset, **SSM-10** Submersible Speaker/Microphone, or **SSM-55A** Earpiece/Microphone. When this jack is used, the internal speaker and microphone are disabled.

⑧ **DATA** jack (Right side)

Use the USB mini type B jack to output the NMEA data, configure the transceiver settings and download the GPS logger data.

⑨ **DISTRESS** key (Right side)

Used to send a DSC Distress Call. To send the distress call, refer to section **“9.3.1 Transmitting a DSC Distress Call”**.

⑩ Soft keys

The 3 programmable soft keys can be customized by the Setup Menu mode described in section **“12.7 SOFT KEYS”**. When one of the soft keys is pressed briefly, the functions will appear above each key on the display.

⑪ Strobe light indicator

When the Emergency feature is activated, this indicator blinks the internationally-recognized Morse Code “S.O.S” message.

When the Water Hazard feature is activated, this indicator illuminates if the transceiver is submerged.

⑫ Speaker

The internal speaker is located here.

⑬ Battery pack lock (Bottom side)



Turn the Battery Pack Lock to the **“UNLOCK”** position for battery removal.

8 BASIC OPERATION

NOTE

Before operating the **HX870** for the first time, it is recommended that you fully charge the battery. See section “**6.1.4 Using the SBH-12 Charger Cradle**” for details.

8.1 TURNING ON AND OFF THE TRANSCEIVER

1. Press and hold the  key on the left side of the radio to turn the radio on.
2. Press and hold the  key again to turn the radio off.

8.2 RECEPTION

1. Press the **SQL** key, then press the **CH▼** key until noise is heard from the speaker. This state is known as “squench off”.
2. Press the **VOL- / VOL+** key until noise or audio from the speaker is at a comfortable level.
3. Press the **SQL** key, then press the **CH▲** key until the random noise disappears. This state is known as the “squench threshold”.
4. Press the **CH▼ / CH▲** key to select the desired channel. Refer to the channel chart on Pages 125 to 127 for available channels.
5. When a message is received, adjust the volume to the desired listening level. The “[**BUSY**]” indicator on the display indicates that communications are being received.

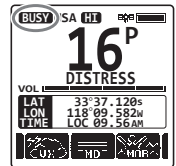

8.3 TRANSMISSION

1. Perform steps 1 through 4 of RECEPTION.
2. Before transmitting, monitor the channel to ensure it is clear.

THIS IS AN FCC REQUIREMENT!

3. Press the **PTT** (push-to-talk) button. The “[**TX**]” indicator on the LCD is displayed.
4. Speak slowly and clearly into the **MIC** hole.
5. When the transmission is finished, release the **PTT** button.

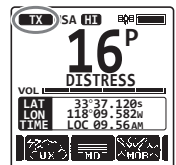

8.3.1 Transmit Power

The TX output power of the **HX870** is set to high level (6W) in factory default, and the “[HI]” indicator is displayed on the top part of the screen.

To switch the TX output power:

1. Press ◀/▶ key repeatedly until the [HI], [MD], or [LOW] soft key is displayed at the bottom of the screen.
2. Press the [HI], [MD], or [LOW] soft key to switch between HI (6W), MD (2W), or LO (1W) output power.

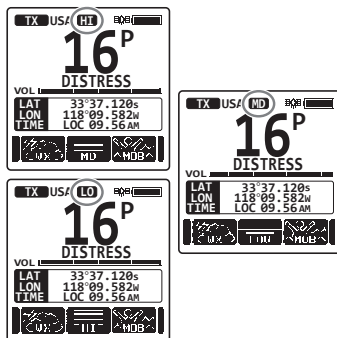

NOTE

- When the **SBT-13** Alkaline Battery Case is used, only the low power (1W) can be set.
- Depending on the remaining power of the **SBR-13LI** Battery Pack, the **HX870** may transmit with the medium or low power even though the “[HI]” indicator is displayed.

8.4 TRANSMIT TIME-OUT TIMER (TOT)

When the **PTT** button is held down, transmit time is limited to 5 minutes. This limits unintentional transmissions due to a stuck microphone. About 10 seconds before automatic transmitter shutdown, a warning beep will be heard from the speaker(s). The transceiver will automatically go to receive mode, even if the **PTT** button is continually held down. Before transmitting again, the **PTT** button must first be released and then pressed again.

NOTE

Once the transmitter is shut down by the TOT, transmission to the last channel is only allowed 10 seconds after the shutdown.

8.5 SIMPLEX/DUPLEX CHANNEL USE

Refer to the VHF MARINE CHANNEL CHART (Pages 125 to 127) for instructions on use of simplex and duplex channels.

NOTE

All channels are factory-programmed in accordance with FCC (USA), Industry Canada (Canada), and International regulations. Mode of operation cannot be altered from simplex to duplex or vice-versa.

8.6 USA, INTERNATIONAL, AND CANADA MODE

To change the channel group from USA to International or Canada:

1. Press the **MENU** key to display “MENU”, then select “SETUP” with the **CH▼/CH▲/◀/▶** key.
2. Press the **[SELECT]** soft key, then press the **CH▼/CH▲** key to select “CH SETUP”.
3. Press the **[SELECT]** soft key, then press the **CH▼/CH▲** key to select “CH GROUP”.
4. Press the **[SELECT]** soft key.
5. Press the **CH▼/CH▲** key to select desired channel group “USA”, “INTL”, or “CAN”.
6. Press the **[ENTER]** soft key to store the selected setting.
7. Press the **CLR** key to return to radio operation.

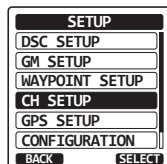
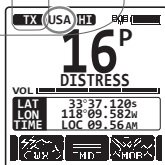
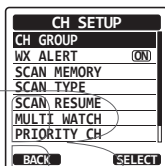
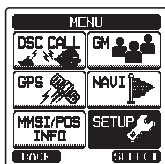

8.7 NOAA WEATHER CHANNELS

1. To receive a NOAA weather channel, press **◀/▶** key repeatedly until the **[WX]** soft key is displayed at the bottom of the screen.
2. Press the **[WX]** soft key. The “WX” indicator appears on the top part of the screen.
3. Press the **CH▼/CH▲** key to select a different NOAA weather channel.
4. To exit from the NOAA weather channels, press the **[CH]** soft key. The transceiver returns to the channel it was on prior to a weather channel and the “WX” indicator disappears from the display.

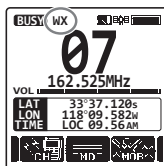
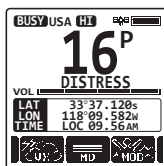

8.7.1 NOAA Weather Alert

In the event of extreme weather disturbances, such as storms and hurricanes, the NOAA (National Oceanic and Atmospheric Administration) sends a weather alert accompanied by a 1050 Hz tone and subsequent weather report on one of the NOAA weather channels.

The **HX870** can receive weather alerts when monitoring a weather channel and, on the last selected weather channel during scanning modes or while on another working channel.

When an alert is received on a NOAA weather channel, scanning will stop and the transceiver will emit a loud beep to alert the user of a NOAA broadcast. Press any key to stop the alert. After stopping the beep sound, the weather alert reception confirmation screen will appear. Press **[OK]** to display a confirmation screen. The confirmation screen will ask you whether to move to the weather channel or return in the marine channel. Press **[YES]** to switch to the weather channel, and press **[NO]** to return to the marine channel.

To disable the weather alert function, refer to section “**14.2 WEATHER ALERT**”.

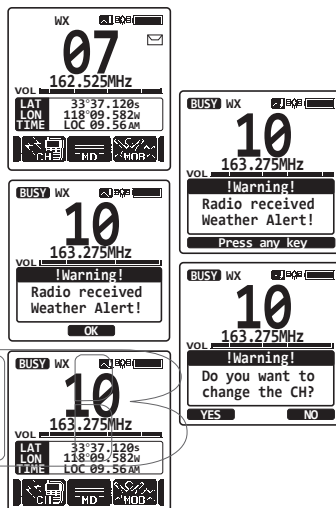

NOTE

If no key is pressed the alert will sound for 5 minutes and then the weather report will be received.

8.7.2 NOAA Weather Alert Testing

NOAA tests the alert system every Wednesday between 11AM and 1PM. To test the **HX870**'s NOAA weather feature, setup as in section “**8.7.1 NOAA Weather Alert**” and confirm the alert is heard on Wednesdays between 11AM and 1PM local time.

8.8 MULTI WATCH (TO PRIORITY CHANNEL)

Multi watch is used to scan two or three channels for communications.

- In Dual Watch, a normal VHF channel and the priority channel are scanned alternately.
- In Triple Watch, a normal VHF channel, the priority channel, and the sub channel are scanned alternately.

When a signal is received on the normal channel the radio briefly switches between the normal channel and the priority channel to look for a transmission. If the radio receives communications on the priority channel the radio stops and listens to priority channel until communication ends and then starts dual or triple watch scan again.

8.8.1 Setting up the Multi Watch Operation

1. Press the **MENU** key to display “MENU”, then select “SETUP” with the **CH▼/CH▲/◀/▶** key.
2. Press the **[SELECT]** soft key, then press the **CH▼/CH▲/◀/▶** key to select “CH SETUP”.
3. Press the **[SELECT]** soft key, then select “MULTI WATCH” with the **CH▼/CH▲** key.
4. Press the **[SELECT]** soft key.
5. Press the **CH▼/CH▲** key to select “DUAL” or “TRIPLE”.
6. Press the **[ENTER]** soft key to store the selected setting.
7. Press the **CLR** key to return to radio operation.

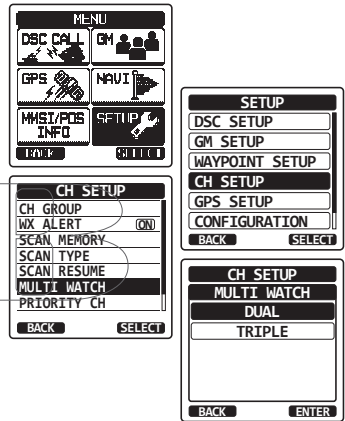

8.8.2 Starting the Dual Watch

1. Press the **SQL** key, then press the **CH▼/CH▲** key until the background noise disappears.
2. Press the **CH▼/CH▲** key to select a channel you wish to watch.
3. Press **◀/▶** key repeatedly until the [Dual Watch] soft key is displayed at the bottom of the screen, press the **[DUAL WATCH]** soft key.

The radio will monitor the priority channel and the channel that was selected in step 2.

If a signal is received on the channel selected in step 2, the **HX870** will dual watch to priority channel.

4. To stop dual watch, press one of the soft keys, then press the **[DUAL WATCH]** soft key again.

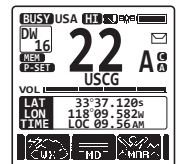

When selecting “TRIPLE” in the SETUP menu, [TRIPLE WATCH] will be displayed as the soft key instead of [DUAL WATCH].

NOTE

The priority channel may be changed from CH16 (default) to another channel. Refer to section “14.7 PRIORITY CHANNEL”.

8.9 SCANNING

The **HX870** will automatically scan channels programmed into the preset channel memory and also the scan channel memory, and the last selected weather channel.

When an incoming signal is detected on one of the channels during scan, the radio will pause on that channel, allowing you to listen to the incoming transmission. The radio will automatically start scanning again after the transmission stops.

8.9.1 Selecting the Scan Type

1. Press the **MENU** key to display “MENU”, then select “SETUP” with the **CH▼/CH▲/◀/▶** key.
2. Press the **[SELECT]** soft key, then press the **CH▼/CH▲/◀/▶** key to select “CH SETUP”.
3. Press the **[SELECT]** soft key, then select “SCAN TYPE” with the **CH▼/CH▲** key.
4. Press the **[SELECT]** soft key.
5. Press the **CH▼/CH▲** key to select “PRIORITY” or “MEMORY”.
6. Press the **[ENTER]** soft key to store the selected setting.
7. Press the **CLR** key to return to radio operation.

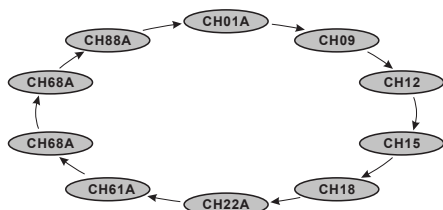
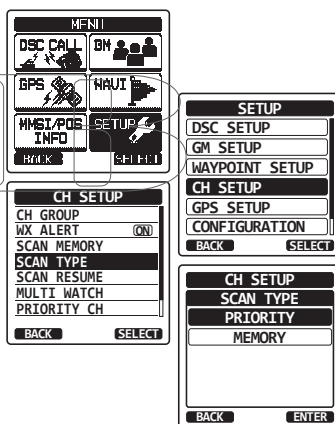

MEMORY SCAN (M-SCAN)

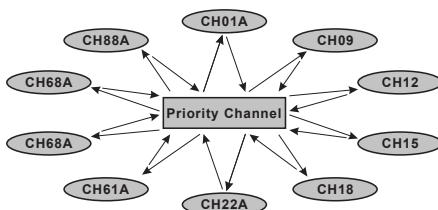

PRIORITY SCAN (P-SCAN)

8.9.2 Programming Scan Memory

1. Press the **MENU** key to display “MENU”, then select “SETUP” with the **CH▼/CH▲/◀/▶** key.
2. Press the **[SELECT]** soft key, then press the **CH▼/CH▲/◀/▶** key to select “CH SETUP”.
3. Press the **[SELECT]** soft key, then press the **CH▼/CH▲** key to select “SCAN MEMORY”.
4. Press the **[SELECT]** soft key.
5. Press the **CH▼/CH▲** key to select a desired channel to be scanned, then press the **[MEM]** soft keys. “ON” icon will appear at the right side of the selected channel.
6. Repeat step 5 for all the desired channels to be scanned.
7. To REMOVE a channel from the list, select the channel then press the **[MEM]** soft key. “ON” icon of the selected channel will disappear.
8. When you have completed your selection, press the **CLR** key to return to radio operation.

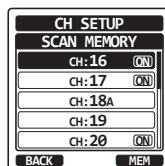
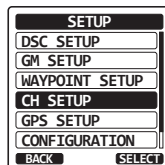
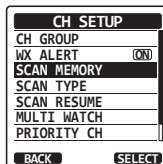
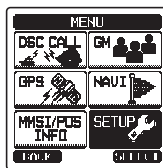

To check channels to be scanned, press the **CH▼/CH▲** key repeatedly. The **[MEM]** icon will appear when the memory channel is displayed.

Note: When “SCAN MEMORY” is assigned to the soft key, the memory function switches between on and off every time you press the **[MEM]** soft key.

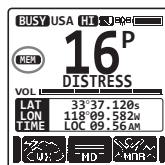

8.9.3 Memory Scanning (M-SCAN)

1. Set the scan type to “MEMORY” in the SETUP menu (refer to “8.9.1 Selecting the Scan Type”).
2. Press the **SQL** key, then press the **CH▼/CH▲** key until background noise disappears.
3. Press the **◀/▶** key repeatedly, then press the **[SCAN]** soft key. “MEM SCAN” appears on the display. Scanning will proceed from the lowest to the highest programmed channel number and preset channel (described in the next section) and will stop on a channel when a transmission is received.

The channel number will blink during reception.

4. To stop scanning, press the **16/S** or **CLR** key.

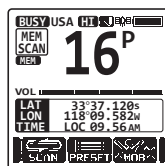

8.9.4 Priority Scanning (P-SCAN)

1. Set the scan type to "PRIORITY" in the SETUP menu (refer to "8.9.1 Selecting the Scan Type").
2. Press the **SQL** key, then press the **CH▼/CH▲** key until background noise disappears.
3. Press the **◀/▶** key repeatedly, then press the **[SCAN]** soft key. "PRI SCAN" appears on the display. Scanning will proceed between the memorized channels and preset channel (described in next section) and the priority channel. The priority channel will be scanned after each programmed channel.
4. To stop scanning, press the **16/S** or **CLR** key.

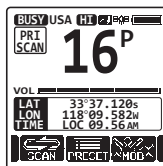

NOTE

In the default setting, Channel 16 is set as the priority channel. You may change the priority channel to the desired channel from Channel 16 on the SETUP menu. Refer to section "14.7 PRIORITY CHANNEL".

8.10 PRESET CHANNELS: INSTANT ACCESS

10 preset channels can be programmed for instant access. Press the **◀/▶** key repeatedly, then press the **[PRESET]** soft key. Pressing the **[PRESET]** key activates the user assigned channel bank. If the **[PRESET]** soft key is pressed and no channels have been assigned, an alert beep will be emitted from the speaker.

Before beginning the Instant Access operation, assign the "PRESET" command into one of the programmable keys, refer to section "12.7 SOFT KEYS".

8.10.1 Programming

1. Press the **CH▼/CH▲** key to select the channel to be programmed.
2. Press the **◀/▶** key repeatedly to indicate the function on the display, then press and hold the **[PRESET]** soft key until the "P-SET" icon and channel number are blinking.
3. Press the **[ADD]** soft key to program the channel into the preset channel memory. "[P-SET]" icon will appear.

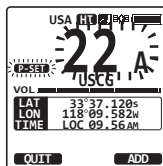
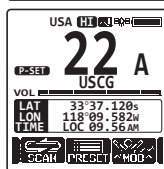
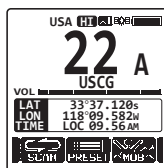

- Repeat steps 1 through 4 to program the desired channels into the preset channels. Up to 10 channels can be registered. If you attempt to register the 11th channel, error beep will sound.

8.10.2 Operation

- Press the ◀/▶ key repeatedly, then press the **[PRESET]** soft key to recall the preset channel. The “**[P-SET]**” icon will appear on the display.
- Press the **CH▼/CH▲** key to select the desired preset channel.
- Press one of soft keys, then press the **[PRESET]** soft key to return to the last selected channel. The “**[P-SET]**” icon will disappear from the display.

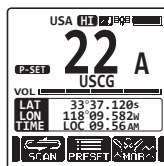
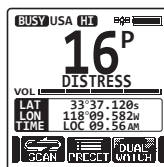

8.10.3 Deletion

- Press the ◀/▶ key repeatedly, then press the **[PRESET]** soft key to recall the preset channel.
- Press the **CH▼/CH▲** key to select the preset channel to be deleted.
- Press one of soft keys, then press and hold the **[PRESET]** soft key until the “**[P-SET]**” icon and channel number are blinking.
- Press the **[DELETE]** soft key to delete the channel from the preset channel memory.
- Repeat steps 2 through 4 to delete the desired channels from preset channels.
- To exit from deleting the preset channels, press the **[QUIT]** soft key.

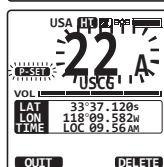
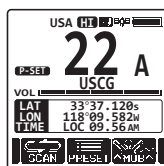

8.11 MOB OPERATION

The **HX870** provides a feature to memorize the position information instantly in case of MOB (Man Over-Board).

1. Press the ◀/▶ key repeatedly, then press the **[MOB]** soft key.
2. Press the **[TO WPT]** soft key to start the navigation to the displayed position. For details about the navigation, see section “**11 NAVIGATION**”.

To modify the displayed position information, press the **[POS/TM]** soft key. For details about the modification, see section “**11.2.3 Editing a Waypoint**”.

3. To transmit a DSC distress message, lift the red spring loaded DISTRESS cover on the right side of the transceiver, then press and hold the **DISTRESS** key (see section “**10.3.1 Transmitting a DSC Distress Call**” for details). The nature of the distress call is automatically set to “MOB”.

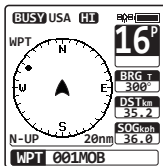
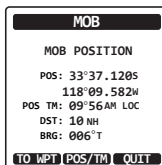
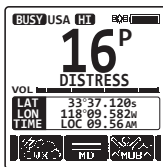

8.12 VOX OPERATION

The **HX870** has the VOX (voice-actuated transmit/receive switching) feature, which allows you to transmit and receive hands free by utilizing the optional VOX headset **VC-24** or those delivered from third-party vendors.

Insert the plug of the VOX headset into the **MIC/SP** jack of the **HX870**, then speak to the microphone of the headset to start VOX operation.

The **VC-24** is optimized for the use with the **HX870**, so that you may use it without detailed settings.

When you use a third-party VOX headset, set up the VOX operation of the **HX870** via the **SETUP** menu. Refer to section “**14.11 VOX OPERATION**” for details.

8.13 OPERATION MENU

The **HX870** provides advanced features below, via the “MENU” screen displayed by pressing the **MENU** key on the front panel.

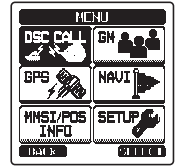

DSC CALL

The following seven types of DSC (Digital Selective Calling) are available: Individual, Group, All Ships, Position Request, Position Report, Polling, and Auto Position Polling.

This menu also provides convenient functions for DSC as below.

- Sets the nature of Distress Call (DIST ALERT MSG)
- Review previously received DSC calls (DSC LOG)
- Transmits a test call (DSC TEST)
- Test the transceiver (DSC LOOP BACK)

GM

The GM (Group Monitor) feature performs group polling and position display of the group members at the same time.

GPS

Your current location, course, and speed can be displayed in a numerical or compass style. You can also check the position and signal strength of captured GPS satellites.

NAVI

You can start navigation to a memorized or temporarily input waypoint.

MMSI/POS INFO

Input your MMSI (Maritime Mobile Service Identity) before you use DSC.

SETUP

This menu allows certain aspects of your transceiver's configuration to be customized for your personal operating conditions.

9 GPS OPERATION

The **HX870** has an internal GPS antenna to receive and display the position information. Your position information as well as received positions can be memorized and utilized later for navigation.

NOTE

The GPS unit may be turned off, or set to power save mode to increase the battery life, via the **SETUP** menu. Refer to section “**15 GPS SETUP**”.

9.1 DISPLAYING POSITION INFORMATION

9.1.1 GPS Information Compass Display

1. Press the **MENU** key to display “MENU”, then select “GPS” with the **CH▼/CH▲/◀/▶** key.
2. Press the **[SELECT]** soft key, then select “COMPASS” with the **CH▼/CH▲** key.
3. Press the **[ENTER]** soft key to display the compass display.
4. Press the **CLR** key to return to radio operation.

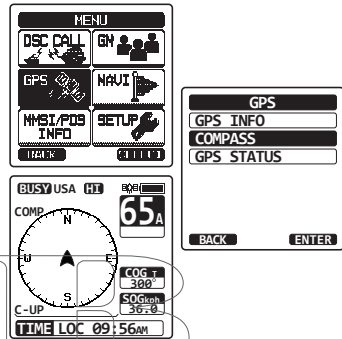

Note: Depending on the assignment of the soft keys you may switch the screen immediately from the basic display to the compass display by pressing the **[COMP]** soft key.

9.1.2 GPS Information Numerical Display

1. Press the **MENU** key to display “MENU”, then select “GPS” with the **CH▼/CH▲/◀/▶** key.
2. Press the **[SELECT]** soft key, then select “GPS INFO” with the **CH▼/CH▲** key.
3. Press the **[ENTER]** soft key to display the numerical display.
4. Press the **CLR** key to return to radio operation.

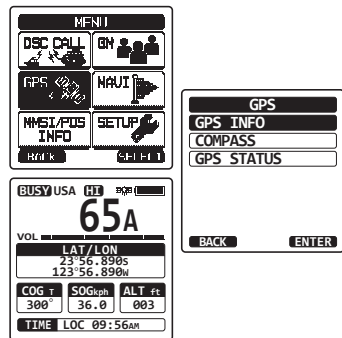

9.2 CHECKING GPS STATUS

1. Press the **MENU** key to display “MENU”, then select “GPS” with the **CH▼/CH▲/◀/▶** key.
2. Press the **[SELECT]** soft key, then select “GPS STATUS” with the **CH▼/CH▲** key.
3. Press the **[ENTER]** soft key to display the GPS status currently being received.
4. Press the **CLR** key to return to radio operation.

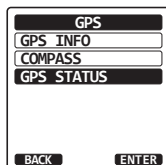
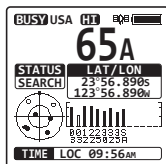
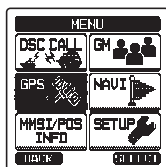

9.3 GPS LOGGER OPERATION

The **HX870** includes a logger for position information that allows you to record your location at regular intervals.

1. Press the **[LOGGER]** soft key to turn the function on or off. The recording starts and the display returns to the previous screen with the “” icon on the top of the display.
 - You may change the log interval time of recording via the **SETUP** menu.

Notes:

- The power save operation of the GPS unit is disabled while the logger is activated.
- To utilize the records, connect the **HX870** to a PC and download the log data from the radio by using the PC Programming Software. Refer to section “**20 CONNECTING A USB DATA TERMINAL TO THE PC**”.

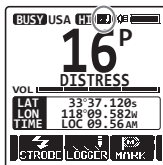
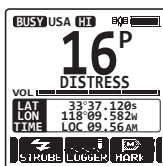

Logger operation alert:

- When the memory for log data becomes full, three beeps will sound and a warning message will be displayed. Afterwards the logger does not operate until the log data in the memory are erased.
- When the logger cannot record for some reason, three beeps will sound and a warning message will be displayed. Afterwards the logger does not operate anymore.
- An error message will be displayed when the radio cannot erase the log data in the memory during the operation following the alert of memory full (see above) or in the **SETUP** menu (Refer to section “**16.13 LOG ERASE**”).

10 DIGITAL SELECTIVE CALLING (DSC)

10.1 GENERAL

WARNING

This **HX870** is designed to generate a digital maritime distress and safety call to facilitate search and rescue. To be effective as a safety device, this equipment must be used only within communication range of a shore-based VHF marine channel 70 distress and safety watch system. The range of signal may vary but under normal conditions should be approximately 5 nautical miles.

Digital Selective Calling (DSC) is a semi-automated method of establishing a radio call, it has been designated by the International Maritime Organization (IMO) as an international standard for establishing VHF, MF and HF radio calls. It has also been designated as part of the Global Maritime Distress and Safety System (GMDSS). It is planned that DSC will eventually replace aural watches on distress frequencies and will be used to announce routine and urgent maritime safety information broadcasts.

This system allows mariners to instantly send a distress call with GPS position (when connected to the transceiver) to the Coast Guard and other vessels within range of the transmission. DSC will also allow mariners to initiate or receive Distress, Urgency, Safety, Routine, Position Request, and Position Report, Automatic Position Polling, and Group calls to or from another vessel equipped with a DSC transceiver.

10.2 MARITIME MOBILE SERVICE IDENTITY (MMSI)

10.2.1 What is an MMSI?

An MMSI is a nine digit number used on marine transceivers capable of using Digital Selective Calling (DSC). This number is used like a telephone number to selectively call other vessels.

THIS NUMBER MUST BE PROGRAMMED INTO THE RADIO TO OPERATE DSC FUNCTIONS.

How can I obtain an MMSI assignment?

In the USA, visit the following websites to register:

<http://www.boatus.com/mmsi/>

<https://www.seatow.com/tools-and-education/mmsi>

http://wireless.fcc.gov/services/index.htm?job=licensing&id=ship_stations

In Canada, visit

<http://www.ic.gc.ca/epic/site/smt-gst.nsf/en/sf01032e.html>

10.2.2 Programming the MMSI

WARNING

The MMSI can be inputted only once. Therefore please be careful not to input the incorrect MMSI number. If you need to change the MMSI number after it has been entered, the radio will have to be returned to Factory Service. Refer to the section “16.2 FACTORY SERVICE”.

1. Press the **MENU** key to display “MENU”.
2. Press the **CH▼/CH▲/◀/▶** key to select “MMSI/POS INFO”, then press the **[SELECT]** soft key. (To cancel, press the **[BACK]** soft key.)
3. Press the **[MMSI]** soft key.
4. Press the **CH▼/CH▲/◀/▶** key to select the first number of your MMSI, then press the **[SELECT]** soft key to step to the next number.
5. Repeat step 4 to set your MMSI number (9 digits).
6. If a mistake was made entering in the MMSI number, press the **CH▼/CH▲/◀/▶** key to select “←” or “→”, press the **[SELECT]** soft key until the wrong character is selected, then perform step 4.
7. When finished programming the MMSI number, press the **[FINISH]** soft key. The radio will ask you to input the MMSI number again. Perform steps 4 through 6 above.
8. After the second number has been input, press the **[FINISH]** soft key to store the MMSI.
9. Press the **[OK]** soft key to return to radio operation.

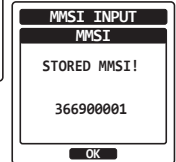
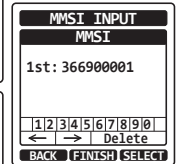
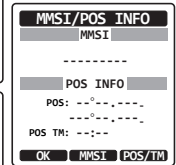
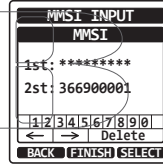
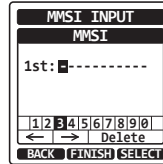

NOTE

To view your MMSI after programming to ensure it is correct, perform steps 1 to 2. Look that the MMSI number shown on the display is correct.

10.3 DSC DISTRESS CALL

The **HX870** is capable of transmitting and receiving DSC distress messages to all DSC radios. Distress calls from the **HX870** include the latitude and longitude of the vessel when the internal GPS unit is activated.

10.3.1 Transmitting a DSC Distress Call

NOTE

To be able to transmit a DSC distress call an MMSI number must be programmed, refer to section “**10.2.2 Programming the MMSI**”.

Basic Operation

1. Lift the red spring loaded DISTRESS cover on the right side of the transceiver, and press then press and hold the **DISTRESS** key for 3 seconds. The radio display will count down (3-2-1) and then transmit the distress call. The backlight of the display and keypad flashes while the radios display is counting down.
2. When the distress signal is sent, the transceiver watches for a transmission on CH70 until an acknowledgment signal is received.
3. If no acknowledgment is received, the distress call is repeated in 4 minute intervals until a DSC acknowledgment is received.
4. When a DSC distress acknowledgment is received, a distress alarm sounds and Channel 16 is automatically selected. The display shows the MMSI of the ship responding to your distress.
5. Press the **PTT** button and state your name, vessel name, number of persons on board and the distress situation, then say “over” and wait for a reply from the acknowledging ship.
6. To turn off the distress alarm before the radio retransmits the distress call, press the **16/S** key or the **[QUIT]** soft key.

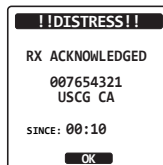
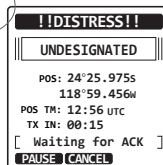
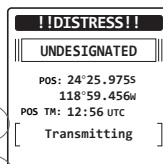
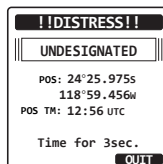

Transmitting a DSC Distress Alert with Nature of Distress

The **HX870** is capable of transmitting a DSC distress alert with the following “Nature of Distress” categories:

- Undesignated, Fire, Flooding, Collision, Grounding, Capsizing, Sinking, Adrift, Abandoning, Piracy, MOB.
- Press the **MENU** key to display “MENU”.
- Press the **CH▼/CH▲/◀/▶** key to select “DSC CALL”, then press the **[SELECT]** soft key.
- Press the **CH▼/CH▲** key to select “DIST ALERT MSG”, then press the **[SELECT]** soft key. (To cancel, press the **[BACK]** soft key.)
- Press the **[NATURE]** soft key. The “NATURE OF” menu will appear on the display.
- Press the **CH▼/CH▲** key to select the desired nature of distress category, then press the **[ENTER]** soft key.
- Press and hold the **DISTRESS** key until a distress alert is transmitted.

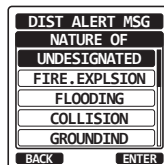
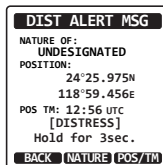
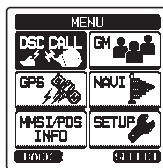

Transmitting a DSC Distress Alert by Manually Inputting Location and Time

In case the **HX870** fails to get a GPS position fix, you may input your latitude and longitude, and time to transmit the distress alert.

- Press the **MENU** key to display “MENU”.
- Press the **CH▼/CH▲/◀/▶** key to select “DSC CALL”, then press the **[SELECT]** soft key.
- Press the **CH▼/CH▲** key to select “DIST ALERT MSG”, then press the **[SELECT]** soft key. (To cancel, press the **[BACK]** soft key.)
- Press the **[POS/TM]** soft key.
- Press the **CH▼/CH▲/◀/▶** key to select the first number of latitude, then press the **[SELECT]** soft key to step to the next number.
- Repeat step 5 to set the position and time. If a mistake was made, press the **CH▼/CH▲/◀/▶** key to select “←” or “→”, press the **[SELECT]** soft key until the wrong character is selected, then perform step 5.

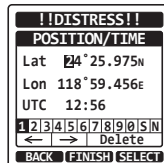
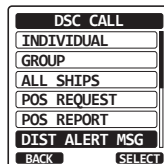
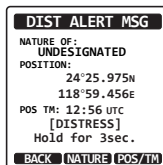
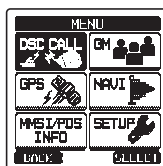

- When finished programming the position and time, press the **[FINISH]** soft key. The display will return to the previous screen.
- Press and hold the **DISTRESS** key until a distress alert is transmitted.

Pausing a DSC Distress Call

After a DSC distress call is transmitted, the DSC distress call is repeated every 4 minutes until the call is canceled by the user or until the radio is turned off and on again. The **HX870** has the capability to suspend (pause) the retransmitting of the distress call by the procedure below.

- After the distress call is transmitted, the radio will show the display as on the right. Looking at this display you will notice "TX IN: 0:15", this is the time when the radio will re-transmit the DSC distress call.
- To suspend re-transmitting the DSC call, press the **[PAUSE]** soft key.
- To resume counting down to transmit the DSC Distress call, press the **[RESUME]** soft key.

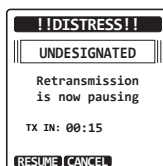
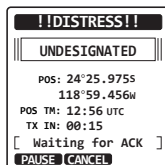

Canceling a DSC Distress Call

If a DSC distress call was sent by error the **HX870** allows you to send a message to other vessels to cancel the distress call that was made.

Press the **[CANCEL]** soft key, then press the **[YES]** soft key.

After the message for cancelling has been transmitted, press the **[OK]** soft key.

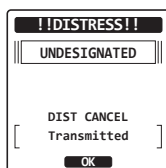
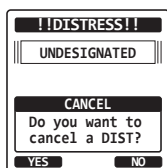

10.3.2 Receiving a DSC Distress Call

- When a DSC distress call is received, an emergency alarm sounds.
- Press any key to stop the alarm.
- Press the **CH ▼** key several times to show information on the vessel in distress.

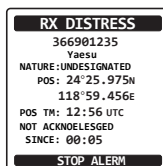

On the display you will notice 3 soft key selections. These selections are described below:

[ACCEPT]: Press this key to accept the DSC distress call and to switch to Channel 16.

Note: If a key is not pressed for 15 seconds or longer the radio will automatically select Channel 16. (Timer setting time is set in “CH SWITCH TIME” from “DSC SETUP”. The default setting is 15 sec.)

[PAUSE]: Press this key to temporarily disable automatic switching to Channel 16.

[QUIT]: Press this key to quit the automatic Channel 16 switching and revert to the last selected working channel.

- After accepting the call, press the **[TO WPT]** soft key to set the vessel in distress as a destination for navigation.

Note: You may change the waypoint name.

- Press the **CH▼/CH▲** key to select “SAVE & GO”, then press the **[SELECT]** soft key to replace the display to the waypoint screen. The display indicates the distance and direction of the distressed vessel, and also the compass indicates the distressed vessel by dot (●).
- To stop navigating to a waypoint, press one of the soft keys, then press the **[STOP]** soft key. The radio is switched to the normal mode.

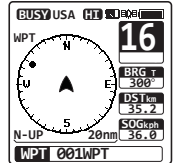
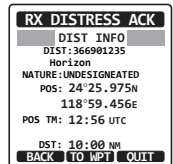
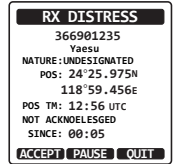

NOTE

- You must continue monitoring Channel 16 as a coast station may require assistance in the rescue attempt.
- When there is an unread distress alert, “✉” icon will appear on the display. You may review the unread distress alert from the DSC log, refer to the section “**10.13.2 Reviewing a Logged DSC Distress Call**”.
- Not all DSC radios can receive a DSC distress relay call.

10.4 ALL SHIPS CALL

The all ships call function allows contact to be established with DSC equipped vessels without having their MMSI in the individual calling directory. Also, priority for the call can be designated as “Urgency” or “Safety”.

URGENCY Call: This type of call is used when a vessel may not truly be in distress, but have a potential problem that may lead to a distress situation. This call is the same as saying “PAN PAN, PAN PAN, PAN PAN” on Channel 16.

SAFETY Call: This type of call is used to transmit boating safety information to other vessels. This message usually contains information about an overdue boat, debris in the water, loss of a navigation aid or an important meteorological message. This call is the same as saying “Securite, Securite, Securite”.

10.4.1 Transmitting an All Ships Call

1. Press the **MENU** key to display “MENU”, then select “DSC CALL” with the **CH▼/CH▲/◀/▶** key.
2. Press the **[SELECT]** soft key, then press the **CH▼/CH▲** key to select “All SHIPS”.
3. Press the **[SELECT]** soft key. (To cancel, press the **[BACK]** soft key.)
4. Press the **CH▼/CH▲** key to select the nature of call (“SAFETY” or “URGENCY”), then press the **[SELECT]** soft key.
5. Press the **CH▼/CH▲** key to select the operating channel you want to communicate on, then press the **[SELECT]** soft key.
6. Press the **[YES]** soft key to transmit the selected type of all ships call.
7. After the all ships call is transmitted, the transceiver will switch to the selected channel.
8. Listen to the channel to make sure it is not busy, then key the microphone and say “PAN PAN, PAN PAN, PAN PAN” or “Securite, Securite, Securite” depending on the priority of the call.
9. Press the **[QUIT]** soft key to exit the all ships call menu.

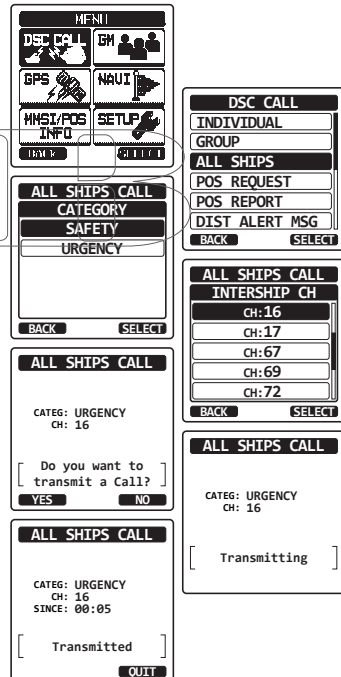

10.4.2 Receiving an All Ships Call

1. When an all ships call is received, an emergency alarm will sound.
The display shows the MMSI of the vessel transmitting the all ships call and the radio will change to the requested channel after 15 seconds (the default setting of “CH SWITCH TIMER”).
2. Press any key to stop the alarm.
3. Monitor the requested channel until the all ships voice communication is completed.

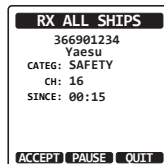
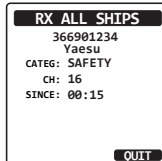

On the display you will notice 3 soft key selections. These selections are described below:

[ACCEPT]: Press this key to accept the DSC all ships call and to switch to requested channel.

Note: If a key is not pressed for 15 seconds or longer the radio will automatically change to the requested channel (the default setting of “CH SWITCH TIMER”).

[PAUSE]: Press this key to temporarily disable automatic switching to the requested channel.

Note: In some cases automatically switching to a requested channel might disrupt important ongoing communications. This feature allows commercial users to suspend channel switching and stay on the working channel selected before the all ships call was received.

[QUIT]: Press this key to quit the automatic channel switching and revert to the last selected working channel.

4. Press the **[QUIT]** key to return to the channel display.

NOTE

When there is an unread all ships call, “” icon will appear on the display. You may review the unread all ships call from the DSC log, refer to the section “**10.13.3 Reviewing Other Logged Calls**”.

10.5 INDIVIDUAL CALL

This feature allows the **HX870** to contact another vessel with a DSC VHF radio and automatically switch the receiving radio to a desired communications channel. This feature is similar to calling a vessel on CH16 and requesting to go to another channel (switching to the channel is private between the two vessels). Up to 100 individual contacts may be programmed.

10.5.1 Setting up the Individual / Position Call Directory

The **HX870** has a DSC directory that allows you to store a vessel or person's name and the associated MMSI number you wish to contact via individual calls, auto polling, position request, position report, and polling transmissions. To transmit an individual call you must program this directory with information of the persons you wish to call, similar to a cellular phones telephone directory.

1. Press the **MENU** key to display "MENU".
2. Press the **CH▼/CH▲/◀/▶** key to select "SETUP".
3. Press the **[SELECT]** soft key, then select "DSC SETUP" with the **CH▼/CH▲** key.
4. Press the **[SELECT]** soft key, then select "INDIVIDUAL DIR." with the **CH▼/CH▲** key.
5. Press the **[SELECT]** soft key.
6. Select "ADD" with the **CH▼/CH▲** key, then press the **[SELECT]** soft key.
7. Press the **CH▼/CH▲** key to scroll through the first letter of the name of the vessel or person you want to reference in the directory.
8. Press the **[SELECT]** soft key to store the first letter in the name and step to the next letter to the right.
9. Repeat steps 7 and 8 until the name is complete. The name can consist of up to eleven characters, and if you do not use all eleven characters, select "→" to move to the next space. This method can also be used to enter a blank space in the name.
If a mistake was made entering in the name, press the **CH▼/CH▲/◀/▶** key to select "←" or "→", press the **[SELECT]** soft key until the wrong character is selected, then perform steps 7 and 8.
10. After the eleventh letter or space has been entered, press the **[FINISH]** soft key to advance to the MMSI number entry.

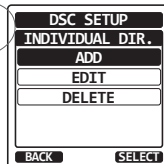
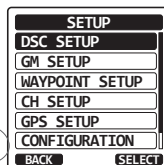
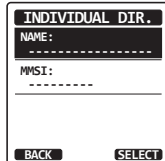
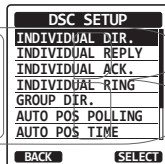
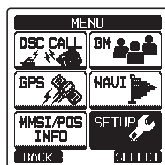

- Press the **CH▼/CH▲** key to scroll through numbers, 0-9. To enter the desired number and move one space to the right by pressing the **[ENTER]** soft key. Repeat this procedure until all nine space of the MMSI number are entered.

If a mistake was made entering in the MMSI number, press the **CH▼/CH▲/◀/▶** key to select “←” or “→”, press the **[SELECT]** soft key until the wrong character is selected, then perform step 11.

- After the ninth letter has been entered, press the **[FINISH]** soft key.

- To store the entered data, press the **CH▼/CH▲/◀/▶** key to select “SAVE”, then press the **[SELECT]** soft key.

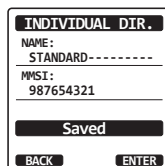

- To enter another individual address, repeat steps 6 through 13.

- Press the **CLR** key to return to radio operation.

10.5.2 Setting up the Individual Call Reply

This menu item sets up the radio to automatically (default setting) or manually respond to a DSC individual call requesting you to switch to a working channel for voice communications. When “Manual” is selected the MMSI of the calling vessel is shown allowing you to see who is calling. This function is similar to caller id on a cellular phone.

- Press the **MENU** key to display “MENU”.
- Press the **CH▼/CH▲/◀/▶** key to select “SETUP”.
- Press the **[SELECT]** soft key, then select “DSC SETUP” with the **CH▼/CH▲** key.
- Press the **[SELECT]** soft key, then select “INDIVIDUAL REPLY” with the **CH▼/CH▲** key.
- Press the **[SELECT]** soft key.
- Press the **CH▼/CH▲** key to select “AUTO” or “MANUAL”.
- Press the **[ENTER]** soft key to store the selected setting.
- Press the **CLR** key to return to radio operation.

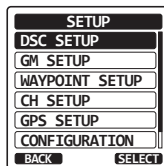
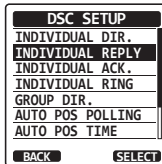
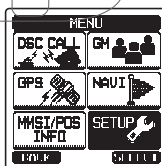

10.5.3 Enabling the Individual Call Acknowledgment

The radio can select either reply message “Able” (default) or “Unable” when the individual reply setting (described in the previous section) is set to “AUTOMATIC”.

1. Press the **MENU** key to display “MENU”.
2. Press the **CH▼/CH▲/◀/▶** key to select “SETUP”.
3. Press the **[SELECT]** soft key, then select “DSC SETUP” with the **CH▼/CH▲** key.
4. Press the **[SELECT]** soft key, then select “INDIVIDUAL ACK.” with the **CH▼/CH▲** key.
5. Press the **[SELECT]** soft key.
6. Press the **CH▼/CH▲** key to select “ABLE” or “UNABLE”.
7. Press the **[ENTER]** soft key to store the selected setting.
8. Press the **CLR** key to return to radio operation.

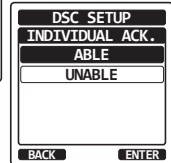
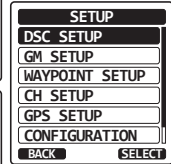
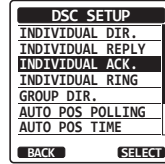

10.5.4 Transmitting an Individual Call

This feature allows the user to contact another vessel with a DSC radio. This feature is similar to calling a vessel on CH16 and requesting to go to another channel.

Individual Call using the Individual/Position Directory

1. Press the **MENU** key to display “MENU”, then select “DSC CALL” with the **CH▼/CH▲/◀/▶** key.
2. Press the **[SELECT]** soft key, then press the **CH▼/CH▲** key to select “INDIVIDUAL”. (To cancel, press the **[BACK]** soft key.)
3. Press the **[SELECT]** soft key.

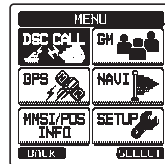

4. Press the **CH▼/CH▲** key to select “HISTORY” or “MEMORY”, then press the **[SELECT]** soft key.
5. Press the **CH▼/CH▲** key to select an individual you want to contact.
6. Press the **[SELECT]** soft key, then press the **CH▼/CH▲** key to select the operating channel you want to communicate on, then press the **[SELECT]** soft key.
7. Press the **[YES]** soft key to transmit the individual DSC signal.
8. When an individual call acknowledgment is received, the established channel is automatically changed to the channel which is selected on step 6 above and a ringing tone sounds.
9. Press the **[QUIT]** soft key to listen to the channel to make sure it is not busy, then press the **PTT** button and talk into the microphone to the other vessel.

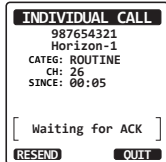
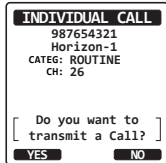
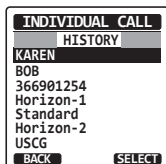
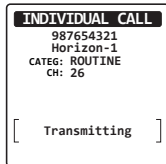
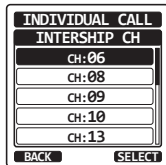
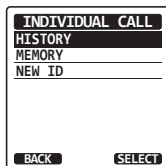

Individual Call by Manually Entering a MMSI

You may enter an MMSI number manually to contact without storing it in the individual directory.

1. Press the **MENU** key to display “MENU”, then select “DSC CALL” with the **CH▼/CH▲/◀/▶** key.
2. Press the **[SELECT]** soft key, then press the **CH▼/CH▲** key to select “INDIVIDUAL”. (To cancel, press the **[BACK]** soft key.)
3. Press the **[SELECT]** soft key.
4. Press the **CH▼/CH▲** key to select “NEW ID”, then press the **[SELECT]** soft key.
5. Press the **CH▼/CH▲** key to select the first number of the MMSI which you want to contact, then press the **[SELECT]** soft key to step to the next number.

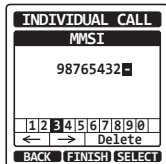
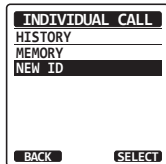

- Repeat step 5 to set the MMSI number (nine digits).

If a mistake was made entering in the MMSI number, press the **CH▼/CH▲/◀/▶** key to select “←” or “→”, press the **[SELECT]** soft key until the wrong character is selected, then perform step 5.

- When finished entering the MMSI number, press the **[FINISH]** soft key.
- Press the **CH▼/CH▲** key to select the operating channel you want to communicate on, then press the **[SELECT]** soft key.

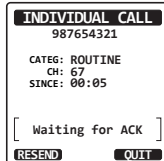
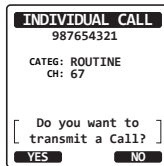
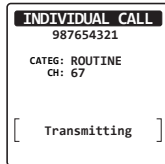
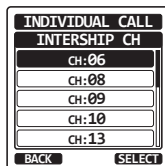

- Press the **[YES]** soft key to transmit the individual DSC signal.
- When an individual call acknowledgment is received, the established channel is automatically changed to the channel which is selected on step 8 above and a ringing tone sounds.
- Press the **[QUIT]** soft key to listen to the channel to make sure it is not busy, then press the **PTT** button and talk into the microphone to the other vessel.

10.5.5 Receiving an Individual Call

When an individual DSC call is received, the radio will automatically respond (default setting) to the calling ship, and switch to the requested channel for voice communications. Refer to section “**10.5.2 Setting up the Individual Call Reply**” to change the reply to manual if you want to see who is calling before replying to the call.

Automatic reply:

- When an individual call is received, an individual call ringing alarm sounds.
The radio automatically switches to the requested channel.
The display shows the MMSI of the vessel calling.
- Press any key to stop the alarm.
- Monitor the requested channel until the message is completed.
Press the **PTT** button and talk into the microphone to the called vessel.
- Press the **[QUIT]** soft key to return to radio operation.

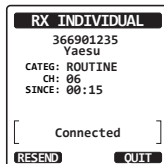
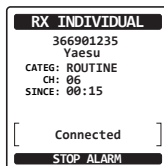

Manual reply:

1. When an individual call is received, an individual call ringing alarm sounds.
The display shows the MMSI of the vessel transmitting the individual call.
2. Press any key to stop the alarm.
3. On the display you will notice 3 soft key selections. These selections are described below:

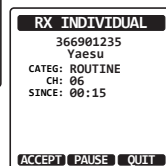
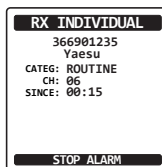

[ACCEPT]: Press this key to accept the DSC individual call and to switch to requested channel.

[PAUSE]: Press this key to temporarily disable automatic switching to the requested channel.

Note: In some cases automatically switching to a requested channel might disrupt important ongoing communications. This feature allows commercial users to suspend channel switching and stay on the working channel selected before the individual call was received.

[QUIT]: Press this key to quit the automatic channel switching and revert to the last selected working channel.

Note: If a key is not pressed for 30 seconds or longer the radio will automatically change to radio operation.

4. After accepting the call, press the **[ABLE]** soft key to switch to the requested channel. (To inform that you cannot respond, press the **[UNABLE]** soft key.)
5. Press the **[YES]** soft key to send an acknowledgement.
Press the **[CHG CH]** soft key to change the channel for communication from the requested one.
6. Monitor the requested or specified channel until the message is completed.
Press the **PTT** button and talk into the microphone to the called vessel.
7. Press the **[QUIT]** soft key to return to the channel display.

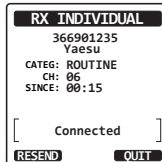
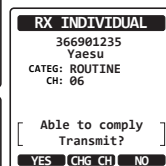
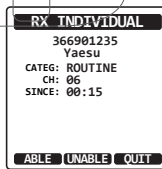

NOTE

When there is an unread individual call, “” icon will appear on the display. You may review the unread individual call from the DSC log, refer to the section “**10.13.3 Reviewing Other Logged Calls**”.

10.5.6 Setting up the Individual Call Ringer

When an individual call is received the radio's default setting will produce a ringing sound for 2 minutes. This selection allows the individual call ringer time to be changed.

1. Press the **MENU** key to display "MENU".
2. Press the **CH▼/CH▲/◀/▶** key to select "SETUP", then press the **[SELECT]** soft key.
3. Select "DSC SETUP" menu with the **CH▼/CH▲** key.
4. Press the **[SELECT]** soft key, then select "INDIVIDUAL RING" with the **CH▼/CH▲** key.
5. Press the **[SELECT]** soft key.
6. Press the **CH▼/CH▲** key to select ringing time of individual calls.
7. Press the **[ENTER]** soft key to store the selected setting.
8. Press the **CLR** key to return to radio operation.

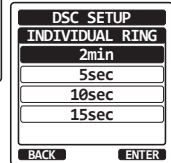
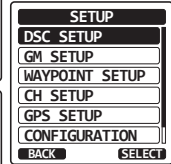
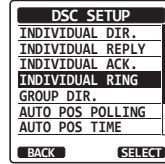
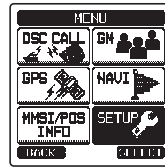

The **HX870** has the capability to turn off the individual call ringer.

1. Press the **MENU** key to display "MENU".
2. Press the **CH▼/CH▲/◀/▶** key to select "SETUP", then press the **[SELECT]** soft key.
3. Select "DSC SETUP" menu with the **CH▼/CH▲** key.
4. Press the **[SELECT]** soft key, then select "DSC BEEP" with the **CH▼/CH▲** key.
5. Press the **[SELECT]** soft key.
6. Press the **CH▼/CH▲** key to select "INDIVIDUAL", then press the **[SELECT]** soft key.
7. Press the **CH▼/CH▲** key to select "OFF".
8. Press the **[ENTER]** soft key to store the selected setting.
9. Press the **CLR** key to return to radio operation.

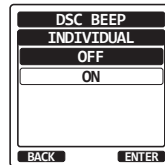
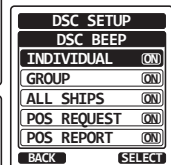
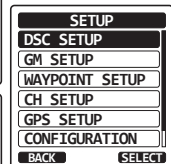
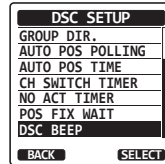
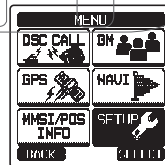

To re-enable the ringer tone, repeat the above procedure, pressing the **CH▼/CH▲** key to select "ON" in step 7 above.

10.6 GROUP CALL

This feature allows the user to contact a group of specific vessels (e.g. members of a yacht club) using DSC radios with the group call function to automatically switch to a desired channel for voice communications. This function is very useful for yacht clubs and vessels traveling together that want to collectively make announcements on a predetermined channel. Up to 20 group MMSIs may be programmed.

10.6.1 Setting up a Group Call

For this function to operate, the same group MMSI (Maritime Mobile Service Identity Number) must be programmed into all the DSC VHF radios within the group of vessels that will be using this feature. To understand Group MMSI programming, first a ship MMSI has to be understood.

Ship MMSI: The first three digits called MID (Mobile Identity Group) of a ship MMSI denote the country where the ship's MMSI is registered. The last 6 digits are specific to the ships ID.

Ship MMSI Example: If your MMSI is "366123456", "366" is MID which denote the country and "123456" is your ships MMSI.

Group MMSI:

- Group MMSI numbers are not assigned by the FCC or other organizations licensed to assign ship MMSI numbers.
- The first digit of a group MMSI is always set to "0" by International rules. All Standard Horizon radios are preset so when programming a group MMSI the first digit is set to "0".
- The USCG recommends programming the MID of a ship MMSI into the Second, Third and Fourth digits of the group MMSI as it denotes the area the ship is located in.
- The last 5 digits are decided upon by persons in the group. This is an important step as all radios in the group must contain the same group MMSI so they can be contacted by each other. There is a chance that another group of vessels may program in the same group MMSI. If this happens, simply change one or more of the last 5 digits of the group MMSI.

1. Press the **MENU** key to display “MENU”.
2. Press the **CH▼/CH▲/◀/▶** key to select “SETUP”, then press the **[SELECT]** soft key.
3. Select “DSC SETUP” with the **CH▼/CH▲** key.
4. Press the **[SELECT]** soft key, then select “GROUP DIR.” with the **CH▼/CH▲** key.
5. Press the **[SELECT]** soft key, then select “ADD” with the **CH▼/CH▲** key.
6. Press the **[SELECT]** soft key.
7. Press the **CH▼/CH▲** key to scroll through the first letter of the name of the group you want to reference in the directory.
8. Press the **[SELECT]** soft key to store the first letter in the name and step to the next letter to the right.
9. Repeat steps 7 and 8 until the name is complete. The name can consist of up to eleven characters, if you do not use all eleven characters, select “→” to move to the next space. This method can also be used to enter a blank space in the name. If a mistake was made entering in the name, press the **CH▼/CH▲/◀/▶** key to select “←” or “→”, press the **[SELECT]** soft key until the wrong character is selected, then perform steps 7 and 8.
10. After the eleventh letter or space has been entered, press the **[FINISH]** soft key to advance to the group MMSI number entry.
11. Press the **CH▼/CH▲** key to select the second number of the MMSI (nine digits: first digit permanently set to “0”) which you want to contact, then press the **[SELECT]** soft key to step to the next number. Repeat this procedure until all eight spaces of the MMSI number are entered. If a mistake was made entering in the MMSI number, press the **CH▼/CH▲/◀/▶** key to select “←” or “→”, press the **[SELECT]** soft key until the wrong character is selected, then perform step 11.
12. After the ninth letter has been entered, press the **[FINISH]** soft key to confirm.
13. To store the data, select “SAVE”, then press the **[SELECT]** soft key.
14. To enter another group address, repeat steps 6 through 13.
15. Press the **CLR** key to return to radio operation.

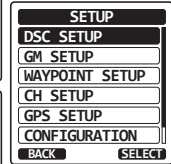
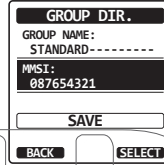
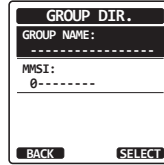
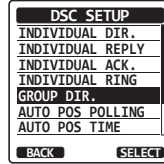

10.6.2 Transmitting a Group Call

Group Call using the Group Directory

1. Press the **MENU** key to display "MENU", select "DSC CALL" with the **CH▼/CH▲/◀/▶** key, then press the **[SELECT]** soft key.
2. Press the **CH▼/CH▲** key to select "GROUP". (To cancel, press the **[BACK]** soft key.)
3. Press the **[SELECT]** soft key, then press the **CH▼/CH▲** key to select "HISTORY" or "MEMORY".
4. Press the **[SELECT]** soft key, then press the **CH▼/CH▲** key to select a group you want to contact.
5. Press the **[SELECT]** soft key, press the **CH▼/CH▲** key to select the operating channel you want to communicate on, then press the **[SELECT]** soft key.
6. Press the **[YES]** soft key to transmit the group call signal.
7. When the group call signal is sent, the display will be as shown in the illustration at the right.
8. After the group call is transmitted, all the radios in the group will switch to the designated channel.
9. Listen to the channel to make sure it is not busy, then press the **PTT** button and call the other vessel you desire to communicate with.

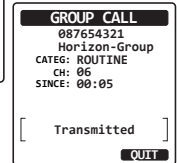
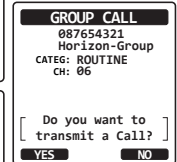
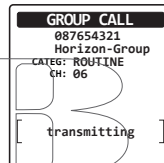
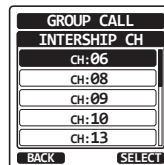
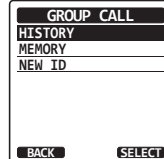
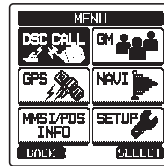

Group Call by Manually Entering an MMSI

This feature allows you to contact a group of vessels by entering in their group MMSI manually.

1. Press the **MENU** key to display “MENU”, then select “DSC CALL” with the **CH▼/CH▲/◀/▶** key.
2. Press the **[SELECT]** soft key, then press the **CH▼/CH▲** key to select “GROUP”. (To cancel, press the **[BACK]** soft key.)
3. Press the **[SELECT]** soft key.
4. Select “NEW ID” with the **CH▼/CH▲** key, then press the **[SELECT]** soft key.
5. Press the **CH▼/CH▲** key to select the first number of the MMSI (nine digits: first digit permanently set to “0”) which you want to contact, then press the **[SELECT]** soft key to step to the next number.
6. Repeat step 5 to set the MMSI number.

If a mistake was made entering in the MMSI number, press the **CH▼/CH▲/◀/▶** key to select “←” or “→”, press the **[SELECT]** soft key until the wrong character is selected, then perform step 5.

7. When finished entering the MMSI number, press the **[FINISH]** soft key.
8. Press the **CH▼/CH▲** key to select the operating channel you want to communicate on, then press the **[SELECT]** soft key.
9. Press the **[YES]** soft key to transmit the group call signal.
10. After the group call is transmitted, all the radios in the group will switch to the designated channel.
11. Listen to the channel to make sure it is not busy, then press the **PTT** button and talk into the microphone to the group of vessels.

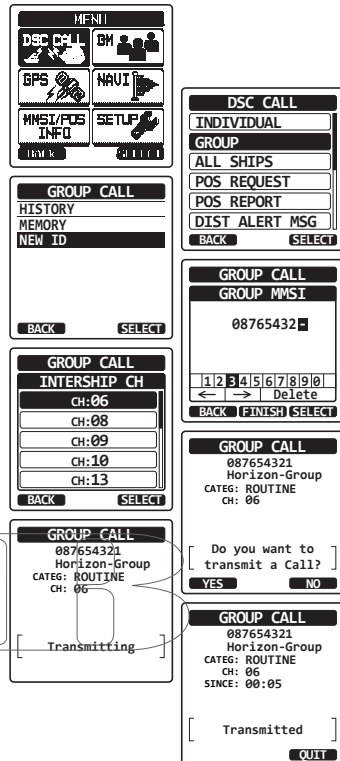

10.6.3 Receiving a Group Call

1. When a group call is received, the **HX870** will produce a ringing alarm sound.
2. The display shows the group MMSI number.
3. Press any key to stop the alarm.
4. Monitor the channel for the person calling the group for a message.

On the display you will notice 3 soft key selections. These selections are described below:

[ACCEPT]: Press this key to accept the group call and to switch to requested channel.

[PAUSE]: Press this key to temporarily disable automatic switching to the requested channel.

[QUIT]: Press this key to quit the automatic channel switching and revert to the last selected working channel.

5. If you want to respond, monitor the channel to make sure it is clear, then press the **PTT** button and talk into the microphone to the group of vessels.
6. Press the **[QUIT]** soft key to return to radio operation.

Note: If a key is not pressed for 30 seconds or longer the radio will automatically change to radio operation.

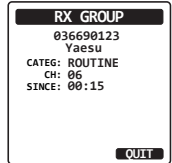

NOTE

When there is an unread group call, “” icon will appear on the display. You may review the unread group call from the DSC log, refer to the section “**10.13.3 Reviewing Other Logged Calls**”.

10.6.4 Setting up the Group Call Ringer

The **HX870** has the capability to turn off the group call ringer.

1. Press the **MENU** key to display “MENU”.
2. Press the **CH▼/CH▲/◀/▶** key to select “SETUP”, then press the **[SELECT]** soft key.
3. Select “DSC SETUP” menu with the **CH▼/CH▲** key.
4. Press the **[SELECT]** soft key, then select “DSC BEEP” with the **CH▼/CH▲** key.
5. Press the **[SELECT]** soft key.
6. Press the **CH▼/CH▲** key to select “GROUP”, then press the **[ENTER]** soft key.
7. Press the **CH▼/CH▲** key to select “OFF”.
8. Press the **[SELECT]** soft key to store the selected setting.
9. Press the **CLR** key to return to radio operation.

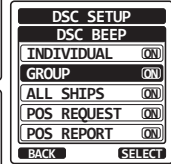
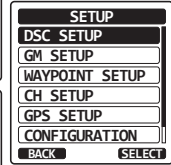
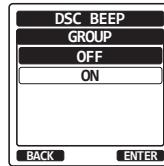
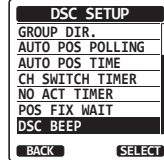

To re-enable the ringer tone, repeat the above procedure, pressing the **CH▼/CH▲** key to select “ON” in step 7 above.

SVWB

10.7 POSITION REQUEST

Advancements in DSC have made it possible to poll the location of another vessel and show the position of that vessel on the display of the **HX870**. This is a great feature for anyone wanting to know the position of another vessel. For example your buddy that is catching fish, or finding the location of a person you are cruising with.

NOTE

The other vessel must have an operating GPS receiver connected to its DSC radio and must not have its radio set not to deny position requests.

10.7.1 Transmitting a Position Request to Another Vessel

Position Request using the Individual/Position Directory

Refer to section “**10.5 INDIVIDUAL CALL**” to enter information into the individual directory.

1. Press the **MENU** key to display “MENU”, select “DSC CALL” with the **CH▼/CH▲/◀/▶** key, then press the **[SELECT]** soft key.
2. Press the **CH▼/CH▲** key to select “POS REQUEST”, then press the **[SELECT]** soft key.
3. Press the **CH▼/CH▲** key to select “HISTORY” or “MEMORY”, then press the **[SELECT]** soft key.
4. Press the **CH▼/CH▲** key to select a name that was stored in the individual/position directory.
5. Press the **[SELECT]** soft key, then press the **[YES]** soft key to transmit the position request DSC call.
6. When the **HX870** receives the position from the polled vessel it is shown on the radio display.
7. Press the **[QUIT]** soft key to return to radio operation.

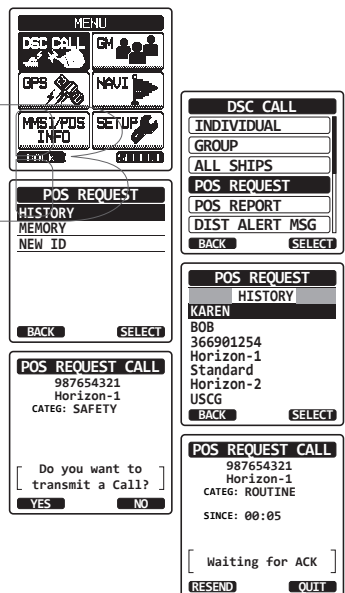

NOTE

If the **HX870** does not receive position data from the polled vessel, the display will show “NO POSITION DATA”.

Position Request by Manually Entering an MMSI

This feature allows you to request the position of a vessel by manually entering the MMSI.

1. Press the **MENU** key to display “MENU”, select “DSC CALL” with the **CH▼/CH▲/◀/▶** key, then press the **[SELECT]** soft key.
2. Press the **[SELECT]** soft key, then press the **CH▼/CH▲** key to select “POS REQUEST”.
3. Press the **[SELECT]** soft key.
4. Press the **CH▼/CH▲** key to select “NEW ID”, then press the **[SELECT]** soft key.
5. Press the **CH▼/CH▲** key to select the first number of the MMSI (nine digits) which you want to contact, then press the **[SELECT]** soft key to step to the next number.
6. Repeat step 5 to set the MMSI number. If a mistake was made entering in the MMSI number, press the **CH▼/CH▲/◀/▶** key to select “←” or “→”, press the **[SELECT]** soft key until the wrong character is selected, then perform step 5.
7. When finished entering the MMSI number, press the **[FINISH]** soft key.
8. Press the **[YES]** soft key to transmit the position request DSC call.
9. When the **HX870** receives the position from the polled vessel it is shown on the radio display.
10. Press the **[QUIT]** soft key to return to radio operation.

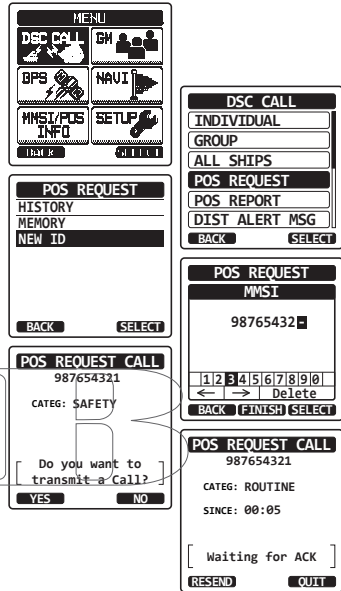

NOTE

The received position from the polled vessel can be transferred to a GPS chart plotter via NMEA DSC and DSE sentences.

10.7.2 Receiving a Position Request

1. When a position request call is received from another vessel, a ringing sound will be produced, and the display will be as shown in the illustration at the right.
2. Press any key to stop the alarm.
3. To send your vessel's position to the requesting vessel, press the **[REPLY]** soft key. Or to exit from position request display, press the **[QUIT]** soft key.
4. Press the **[QUIT]** soft key to return to the channel display.

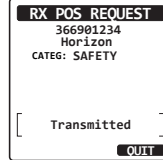

NOTE

When there is an unread position request call, “✉” icon will appear on the display. You may review the unread individual call from the DSC log, refer to the section “**10.13.3 Reviewing Other Logged Calls**”.

10.7.3 Manual Input of Position Information

If the **HX870** is located in an area where GPS reception is limited when you are going to reply to the received position request, you may manually input your location (latitude and longitude) and time to be sent.

1. Press the **MENU** key to display “MENU”.
2. Press the **CH▼/CH▲/◀/▶** key to select “MMSI/POS INFO”, then press the **[SELECT]** soft key.
3. Press the **[POS/TM]** soft key.
4. Press the **CH▼/CH▲/◀/▶** key to select the first number of latitude, then press the **[SELECT]** soft key to step to the next number.
5. Repeat step 4 to set the position and time. If a mistake was made, press the **CH▼/CH▲/◀/▶** key to select “←” or “→”, press the **[SELECT]** soft key until the wrong character is selected, then perform step 4.
6. When finished programming the position and time, press the **[FINISH]** soft key. The display will return to the previous screen.

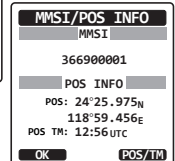
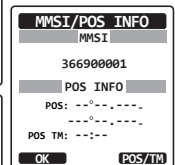
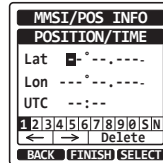
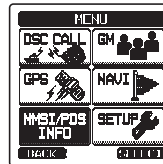

7. Press the **[OK]** soft key.
8. Press the **CLR** key to return to radio operation.

10.7.4 Setting up a Position Request Ringer

The **HX870** has the capability to turn off the position request ringer.

1. Press the **MENU** key to display “MENU”.
2. Press the **CH▼/CH▲/◀/▶** key to select “SETUP”, then press the **[SELECT]** soft key.
3. Select “DSC SETUP” with the **CH▼/CH▲** key.
4. Press the **[SELECT]** soft key, then select “DSC BEEP” with the **CH▼/CH▲** key.
5. Press the **[SELECT]** soft key, then select “POS REQUEST” with the **CH▼/CH▲** key.
6. Press the **[SELECT]** soft key, then select “OFF” with the **CH▼/CH▲** key.
7. Press the **[ENTER]** soft key to store the selected setting.

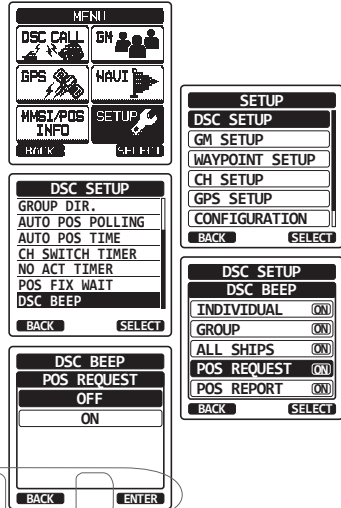

8. Press the **CLR** key to return to radio operation.

To re-enable the ringer tone, repeat the above procedure, pressing the **CH▼/CH▲** key to select “ON” in step 6 above.

10.8 POSITION REPORT

The feature is similar to position request, however instead of requesting a position of another vessel this function allows you to send your position to another vessel.

10.8.1 Transmitting a DSC Position Report Call

DSC Position Report Call using the Individual/Position Directory

Refer to section “10.5 INDIVIDUAL CALL” to enter information into the individual directory.

1. Press the **MENU** key to display “MENU”, select “DSC CALL” with the **CH▼/CH▲/◀/▶** key, then press the **[SELECT]** soft key.
2. Press the **CH▼/CH▲** key to select “POS REPORT”. (To cancel, press the **[BACK]** soft key.)
3. Press the **[SELECT]** soft key.
4. Press the **CH▼/CH▲** key to select “HISTORY” or “MEMORY”.
5. Press the **[SELECT]** soft key.
6. Press the **CH▼/CH▲** key to select the name in the directory, then press the **[SELECT]** soft key.
7. Press the **[YES]** soft key to send your position to the selected vessel.
8. Press the **[QUIT]** soft key to return to radio operation.

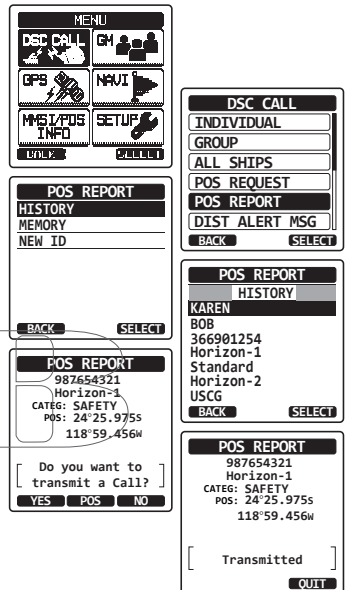

DSC Position Report Call by Manually Entering an MMSI

This feature allows you to send your position to another vessel by manually entering the MMSI of the ship you want to send your position to.

1. Press the **MENU** key to display “MENU”, select “DSC CALL” with the **CH▼/CH▲/◀/▶** key, then press the **[SELECT]** soft key.
2. Press the **CH▼/CH▲** key to select “POS REPORT”. (To cancel, press the **[BACK]** soft key.)
3. Press the **[SELECT]** soft key.
4. Press the **CH▼/CH▲** key to select “NEW ID”, then press the **[SELECT]** soft key.
5. Press the **CH▼/CH▲** key to select the first number of the MMSI which you want to contact, then press the **[SELECT]** soft key to step to the next number.
6. Repeat step 5 to set the MMSI number. If a mistake was made entering in the MMSI number, press the **CH▼/CH▲/◀/▶** key to select “←” or “→”, press the **[SELECT]** soft key until the wrong character is selected, then perform step 5.
7. When finished entering the MMSI number, press the **[FINISH]** soft key.
8. If you want to change the position displayed, press the **[POS/TM]** soft key to go to the position information input screen. After inputting new position information, press the **[FINISH]** soft key to confirm.
9. Press the **[YES]** soft key to send your position to the selected vessel.
10. Press the **[QUIT]** soft key to return to radio operation.

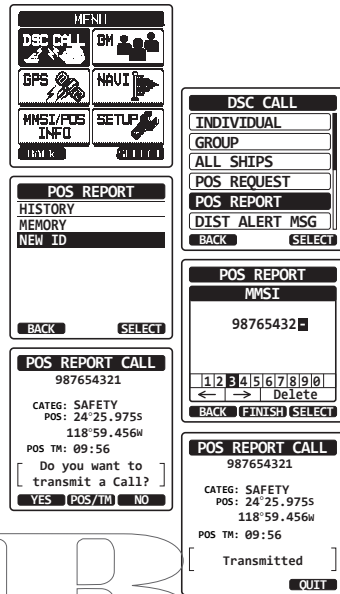

DSC Position Report Call by Manually Input Location and Time

If the **HX870** is located in an area where GPS reception is limited when you are going to transmit a position report call, you may manually input your location (latitude and longitude) and time to be sent. For details, refer to section “**10.7.3 Manual Input of Position Information**”.

10.8.2 Receiving a DSC Position Report Call

When another vessel transmits their vessels location to the **HX870** the following will happen:

1. When a position report call is received from another vessel, a ringing sound will be produced.
2. Press any key to stop ringing.
3. Press the **[INFO]** soft key to see more detailed position information of the station.
4. To exit to radio mode, press the **[QUIT]** soft key.

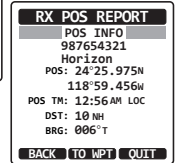
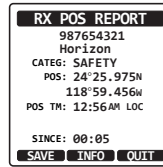

10.8.3 Navigating to the Reported Position

The **HX870** has a feature that allows you to navigate to a received position report call by using the compass display. Navigating to the position of a position report call may be enabled by the procedure below.

1. After the position report call has been received, press the **[INFO]** soft key.
2. Press the **[TO WPT]** soft key.
3. To start navigation using the compass display, select "GOTO" with the **CH▼/CH▲** key, then press the **[ENTER]** soft key.

The display indicates the distance and direction of the received vessel, and also the compass indicates the received vessel with a dot (●).

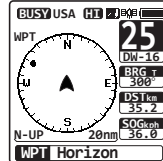
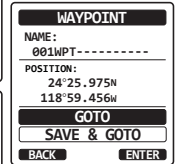
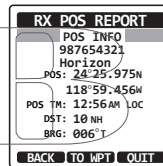

Stopping Navigation to the Reported Position

1. Press one of the soft keys to show the key selections.
2. Press the **[STOP]** soft key. The radio will stop navigating to the waypoint and the normal VHF display will be shown.

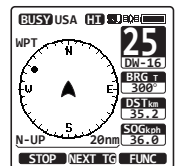

10.8.4 Saving the Reported Position as a Waypoint

The **HX870** can save a position report call in the radio's memory as a waypoint.

1. After the position report call has been received, press the **[SAVE]** soft key.
2. If you want to change the name of the waypoint, press the **CH▼/CH▲** key to select "NAME", then press the **[SELECT]** soft key.
3. Enter the name of the waypoint you want to reference in the directory. For details, refer to "**10.5.1 Setting up the Individual / Position Call Directory**".
4. Press the **CH▼/CH▲** key to select "SAVE", then press the **[ENTER]** soft key to save the waypoint into memory.
5. Press the **[OK]** soft key to return to the position report display.

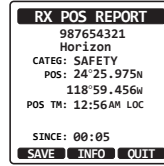

RX POS REPORT
987654321
Horizon
CATEG: SAFETY
POS: 24°25.975N
118°59.456W
POS TM: 12:56AM LOC
SINCE: 00:05
SAVE INFO QUIT



WAYPOINT DIR.
NAME
S -----
[A B C D E F G H I J K L]
[M N O P Q R S T U V W X]
[Y Z 1 2 3 4 5 6 7 8 9 0]
[< a& > Delete]
BACK FINISH SELECT

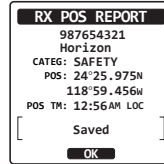

RX POS REPORT
987654321
Horizon
CATEG: SAFETY
POS: 24°25.975N
118°59.456W
POS TM: 12:56AM LOC
[Saved]
OK

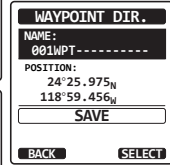

WAYPOINT DIR.
NAME:
001WPT-----
POSITION:
24°25.975N
118°59.456W
SAVE
BACK SELECT

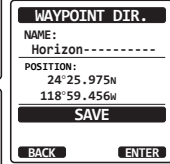

WAYPOINT DIR.
NAME:
Horizon-----
POSITION:
24°25.975N
118°59.456W
SAVE
BACK ENTER

Navigating to a Saved Waypoint

Refer to section "**11.1 STARTING NAVIGATION**" for details.



10.8.5 Setting up a Position Report Ringer

The **HX870** has the capability to turn off the position report ringer.

1. Press the **MENU** key to display “MENU”.
2. Press the **CH▼/CH▲/◀/▶** key to select “SETUP”, then press the **[SELECT]** soft key.
3. Select “DSC SETUP” menu with the **CH▼/CH▲** key.
4. Press the **[SELECT]** soft key, then select “DSC BEEP” with the **CH▼/CH▲** key.
5. Press the **[SELECT]** soft key, then select “POS REPORT” with the **CH▼/CH▲** key.
6. Press the **[SELECT]** soft key, then select “OFF” with the **CH▼/CH▲** key.
7. Press the **[SELECT]** soft key to store the selected setting.
8. Press the **CLR** key to return to radio operation.

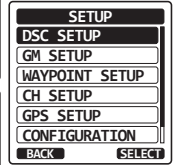
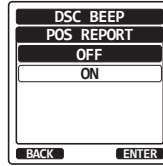
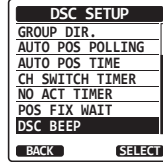

To re-enable the ringer tone, repeat the above procedure, pressing the **CH▼/CH▲** key to select “ON” in the step 6 above.



10.9 POLLING CALL

The **HX870** has the capability to track another vessel.

10.9.1 Transmitting a Polling Call to a Vessel

Polling Call using the Individual/Position Call Directory

1. Press the **MENU** key to display “MENU”, select “DSC CALL” with the **CH▼/CH▲/◀/▶** key, then press the **[SELECT]** soft key.
2. Press the **CH▼/CH▲** key to select “POLLING”, then press the **[SELECT]** soft key.
3. Press the **CH▼/CH▲** key to select “HISTORY” or “MEMORY”, then press the **[SELECT]** soft key.
4. Press the **CH▼/CH▲** key to select a name that was stored in the individual/position call directory, then press the **[ENTER]** soft key.
5. Press the **[YES]** soft key to transmit the polling call.
6. After a polling call is transmitted, if the reply signal is not received, “Waiting for ACK” is shown on the display which means the **HX870** is waiting for the vessel you called to send an acknowledgement.
7. To transmit the call again, press the **[RESEND]** soft key.
8. Press the **[QUIT]** soft key to return to radio operation.

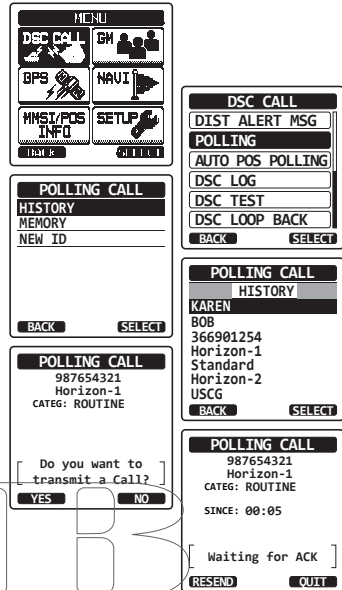

Polling Call by Manually Entering an MMSI

This feature allows you to contact a vessel by manually entering the MMSI of the ship you want to track.

1. Press the **MENU** key to display “MENU”, select “DSC CALL” with the **CH▼/CH▲/◀/▶** key, then press the **[SELECT]** soft key.
2. Press the **CH▼/CH▲** key to select “POLLING”, then press the **[SELECT]** soft key.
3. Press the **CH▼/CH▲** key to select “NEW ID” and press the **[SELECT]** soft key.
4. Press the **CH▼/CH▲** key to select the first number in the MMSI and press the **[SELECT]** soft key.
5. Repeat step 4 until all the digits of the MMSI are shown on the display.
6. If a mistake was made entering in the MMSI number, press the **CH▼/CH▲/◀/▶** key to select “←” or “→”, press the **[SELECT]** soft key until the wrong character is selected, then perform step 5.
7. When finished entering the MMSI number, press the **[FINISH]** soft key.
8. Press the **[YES]** soft key to transmit the polling call.
9. Press the **[QUIT]** soft key to return to radio operation.

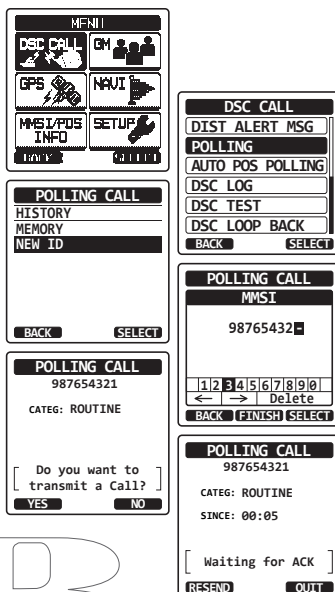

10.9.2 Receiving a Polling Call

When another vessel transmits a polling call to the **HX870** the following will happen:

1. When a polling call is received, the radio will automatically respond to the calling vessel.
2. To exit from the polling call display, press the **[QUIT]** soft key.

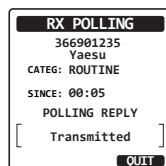

10.10 AUTO POS POLLING

The **HX870** has the capability to automatically track seven vessels programmed into the individual directory, or to automatically send your position information to the programmed stations.

10.10.1 Setting up the Polling Operation

1. Press the **MENU** key to display "MENU".
2. Press the **CH▼/CH▲/◀/▶** key to select "SETUP", then press the **[SELECT]** soft key.
3. Select "DSC SETUP" menu with the **CH▼/CH▲** key.
4. Press the **[SELECT]** soft key, then select "AUTO POS POLLING" with the **CH▼/CH▲** key.
5. Press the **[SELECT]** soft key.
6. Press the **CH▼/CH▲** key to select the desired operation (AUTO POS REQUEST and AUTO POS REPORT), and press the **[ENTER]** soft key.
7. Press the **CLR** key to return to radio operation.

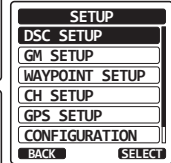
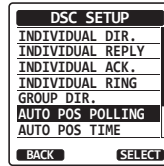

10.10.2 Setting up the Polling Time Interval

1. Press the **MENU** key to display "MENU".
2. Press the **CH▼/CH▲/◀/▶** key to select "SETUP", then press the **[SELECT]** soft key.
3. Select "DSC SETUP" menu with the **CH▼/CH▲** key.
4. Press the **[SELECT]** soft key, then select "AUTO POS TIME" with the **CH▼/CH▲** key.
5. Press the **[SELECT]** soft key.
6. Press the **CH▼/CH▲** key to select the desired interval time (30 second, 1, 2, 3, and 5 minutes) and press the **[ENTER]** soft key.
7. Press the **CLR** key to return to radio operation.

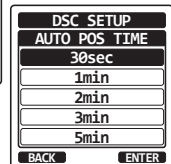
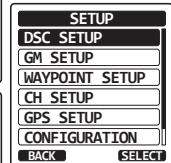
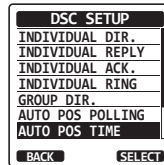
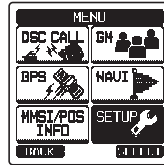

10.10.3 Selecting Vessels to be Automatically Polled

NOTE

The radio uses the individual directory to select vessels to be automatically polled. Refer to section “10.5.1 Setting up the Individual / Position Call Directory” and to enter MMSI of vessels you want to poll before proceeding.

1. Press the **MENU** key to display “MENU”, select “DSC CALL” with the **CH▼/CH▲/◀/▶** key, then press the **[SELECT]** soft key.
2. Press the **CH▼/CH▲** key to select “AUTO POS POLLING”, then press the **[SELECT]** soft key.
3. Press the **CH▼/CH▲** key to select the “SELECT ID”, then press the **[SELECT]** soft key.
4. The radio will show a blank row highlighted when you select the vessel for the first time. Press the **[SELECT]** soft key.
5. The radio will show the vessels programmed in the individual directory. Press the **CH▼/CH▲** key to select the desired vessel and press the **[ENTER]** soft key.
6. For more entries, press the **CH▼/CH▲** key to select a blank row, press the **[SELECT]** soft key, then perform step 5.
7. When finished, press the **CLR** key to exit to the radio mode.

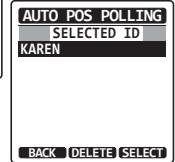
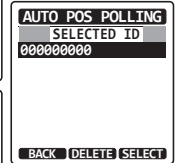
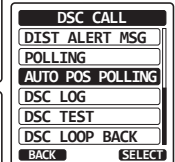
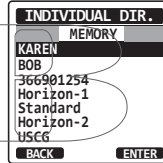
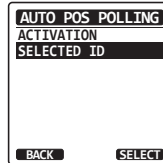
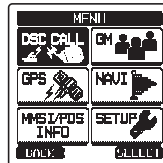

10.10.4 Enabling/Disabling Auto POS Polling

1. Press the **MENU** key to display “MENU”, select “DSC CALL” with the **CH▼/CH▲/◀/▶** key, then press the **[SELECT]** soft key.
2. Press the **CH▼/CH▲** key to select “AUTO POS POLLING”, then press the **[SELECT]** soft key.
3. Press the **CH▼/CH▲** key to select the “ACTIVATION”, then press the **[SELECT]** soft key.
4. Select “START” to enable transmissions or “STOP” to disable.
5. Press the **[ENTER]** soft key.
6. Press the **CLR** key to return to radio operation.
7. Auto POS Polling starts and “A” icon will light up on the screen.

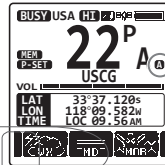
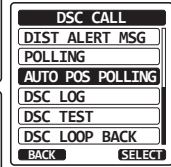
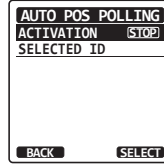

SVLB

10.11 DSC TEST

This function is used to contact another DSC equipped vessel to ensure the DSC functions of the radio are operating.

NOTE

To use this feature, the radio that will receive the test call also needs to have the DSC Test feature.

To perform the DSC test you will need to enter a MMSI of another vessel into the individual directory or manually enter in the MMSI using the procedure below.

10.11.1 Programming MMSI into Individual Directory

Refer to section “10.5.1 Setting up the Individual / Position Call Directory”.

10.11.2 Transmitting a DSC Test to Another Vessel

DSC Test call by using Individual/Position Directory

1. Press the **MENU** key to display “MENU”, select “DSC CALL” with the **CH▼/CH▲/◀/▶** key, then press the **[SELECT]** soft key.
2. Press the **CH▼/CH▲** key to select “DSC TEST”, then press the **[SELECT]** soft key.
3. Press the **CH▼/CH▲** key to select “HISTORY” or “MEMORY”, then press the **[SELECT]** soft key.
4. Press the **CH▼/CH▲** key to select the ship name and press the **[SELECT]** soft key.
5. Press the **[YES]** soft key to transmit the DSC test call to the other vessel.
6. Press the **[QUIT]** soft key to return to radio operation.

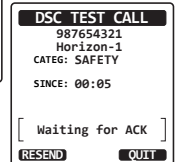
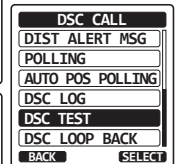
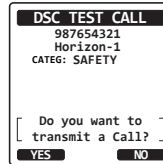
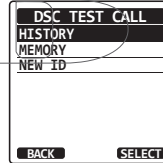
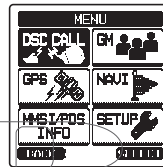

DSC Test Call by Manually Entering an MMSI

1. Press the **MENU** key to display "MENU", select "DSC CALL" with the **CH▼/CH▲/◀/▶** key, then press the **[SELECT]** soft key.
2. Press the **CH▼/CH▲** key to select "DSC TEST", then press the **[SELECT]** soft key.
3. Press the **CH▼/CH▲** key to select "NEW ID" and press the **[SELECT]** soft key.
4. Press the **CH▼/CH▲** key to select the first digit in the MMSI and press the **[SELECT]** soft key.
5. Repeat step 4 until all the numbers of the MMSI are shown on the display.
6. Press the **[FINISH]** soft key to show the test call page.
7. Press the **[YES]** soft key to transmit the DSC test call to the other vessel.
8. Press the **[QUIT]** soft key to return to radio operation.

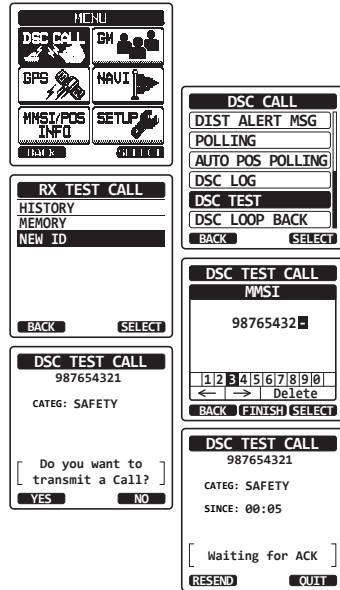

NOTE

After the radio receives a test call reply from the vessel that was called, the radio will ring and show "RX TEST CALL" display, which confirms the radio you called has received the test call.

10.11.3 Receiving a DSC Test Call

When another vessel transmits a DSC Test call to the **HX870** the following will happen:

1. When a DSC Test call is received, the radio will automatically respond to the calling vessel.
2. To exit from the DSC Test call display, press the **[QUIT]** soft key.

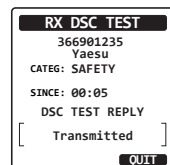

10.12 DSC LOG OPERATION

The **HX870** logs transmitted calls, received DSC distress calls, and other calls (individual, group, all ships, etc.). The DSC log feature is similar to an answer machine where calls are recorded for review and a “” icon will appear on the radios display. The **HX870** can store up to 24 transmitted calls, up to the latest 27 distress calls, and up to the latest 64 other calls (individual, group, all ships, position report, position request ack, test call ack, and polling calls).

NOTE

When the “DSC LOG” menu is selected, the **HX870** may display high-priority logged call automatically.

10.12.1 Reviewing and Resending a Transmitted Logged Call

The **HX870** allows transmitted logged calls to be reviewed and to resend the call.

1. Press the **MENU** key to display “MENU”, then select “DSC CALL” with the **CH▼/CH▲/◀/▶** key.
2. Press the **[SELECT]** soft key, then press the **CH▼/CH▲** key to select “DSC LOG”.
3. Press the **[SELECT]** soft key, then confirm “TRANSMITTED” is selected.
4. Press the **[SELECT]** soft key, then press the **CH▼/CH▲** key to select the station (name or MMSI number) you want to review and/or resend the call.
5. Press the **[SELECT]** soft key to review details for the selected station.
6. Press the **[CALL]** soft key to resend the call or press the **[BACK]** soft key to go back to the DSC transmitted call list.

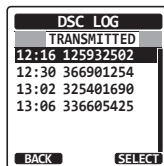
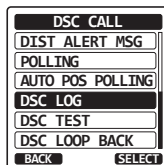
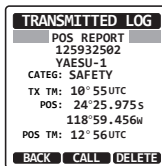

10.12.2 Reviewing a Logged DSC Distress Call

The **HX870** allows logged DSC distress call to be reviewed.

1. Press the **MENU** key to display “MENU”, then select “DSC CALL” with the **CH▼/CH▲/◀/▶** key.
2. Press the **[SELECT]** soft key, then press the **CH▼/CH▲** key to select “DSC LOG”.
3. Press the **[SELECT]** soft key, then press the **CH▼/CH▲** key to select “RX DISTRESS”.
4. Press the **[SELECT]** soft key, then press the **CH▼/CH▲** key to select the station (name or MMSI number) you want to review and/or relay the distress call to other vessels.

Note: When there is an unread received call, “” icon will appear at the head of the call’s row.

5. Press the **[SELECT]** soft key to review details for the selected station.
6. Press the **[INFO]** soft key to display more information or press the **[BACK]** soft key to go back to the received DSC distress call list.

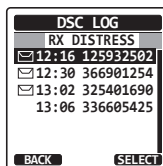
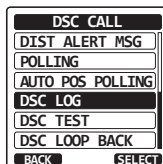
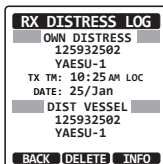

10.12.3 Reviewing Other Logged Calls

1. Press the **MENU** key to display “MENU”, then select “DSC CALL” with the **CH▼/CH▲/◀/▶** key.
2. Press the **[SELECT]** soft key, then press the **CH▼/CH▲** key to select “DSC LOG”.
3. Press the **[SELECT]** soft key, then press the **CH▼/CH▲** key to select “RX OTHER CALL”.
4. Press the **[SELECT]** soft key, then press the **CH▼/CH▲** key to select the station (name or MMSI number) you want to review and/or call back.

Note: When there is an unread received call, “” icon will appear at the head of the call’s row.

5. Press the **[SELECT]** soft key to review details for the selected station.
6. Press the **[CALL]** soft key to reply to the call or press the **[BACK]** soft key to go back to the received call list.

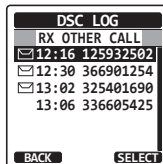
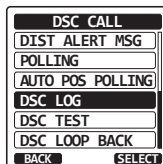
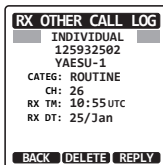

10.12.4 Deleting Logged Calls from the DSC Log Directory

1. Press the **MENU** key to display “MENU”, then select “DSC CALL” with the **CH▼/CH▲/◀/▶** key.
2. Press the **[SELECT]** soft key, then press the **CH▼/CH▲** key to select “DSC LOG”.
3. Press the **[SELECT]** soft key, then press the **CH▼/CH▲** key to select “LOG DELETE” menu.
4. Press the **[SELECT]** soft key, then press the **CH▼/CH▲** key to select the category (“TRANSMITTED”, “RX DISTRESS”, “RX OTHER CALL” or “ALL LOG”) to be deleted.
5. Press the **[SELECT]** soft key.
The display will show “Do you want to delete the LOG?”.
6. Press the **[YES]** soft key. (To cancel, press the **[NO]** soft key.)
7. Press the **CLR** key to return to radio operation.

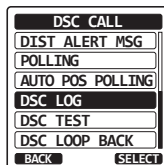
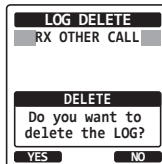
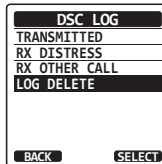
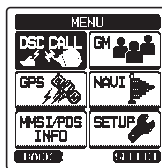

NOTE

The procedure above will delete all logged calls of the selected category at one time.

To delete logged calls one by one, review the details of the call you want to delete, then press the **[DELETE]** soft key.

10.13 DSC LOOP BACK OPERATION

The **HX870** has a self-test feature for DSC call.

1. Press the **MENU** key to display “MENU”, then select “DSC CALL” with the **CH▼/CH▲/◀/▶** key.
2. Press the **[SELECT]** soft key, then press the **CH▼/CH▲** key to select “DSC LOOP BACK”.
3. Press the **[SELECT]** soft key, then press the **[YES]** soft key to start a test. (To cancel, press the **[NO]** soft key.)

The display will show “Passed!” if the DSC feature properly operates, then return to the “DSC CALL” menu.

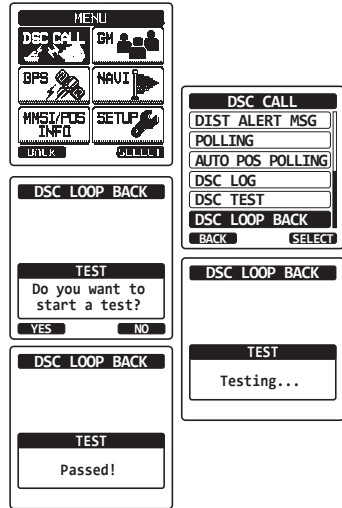

4. Press the **CLR** key to return to radio operation.

SVB

11 NAVIGATION

The **HX870** is capable of storing up to 200 waypoints for navigation using the compass page.

You can also navigation to DSC distress calls with position or a position received from another DSC radio using DSC polling.

11.1 WAYPOINT OPERATION

11.1.1 Starting and Stopping Navigation

Navigation by Using the Waypoint Directory

1. Press the **MENU** key to display “MENU”.
2. Select “NAVI” with the **CH▼/CH▲/◀/▶** key, then press the **[SELECT]** soft key.
3. Select “WAYPOINT” with the **CH▼/CH▲** key, then press the **[SELECT]** soft key.
4. Select the desired category (“HISTORY” or “MEMORY”) with the **CH▼/CH▲** key, then press the **[SELECT]** soft key.
5. Press the **CH▼/CH▲** key to select a waypoint, then press the **[SELECT]** soft key. The navigation screen will appear. The screen includes the distance and direction to the destination, and the waypoint is indicated by a dot (●) inside the compass.
6. Press **◀/▶** key, then press the **[STOP]** soft key to stop the navigation.

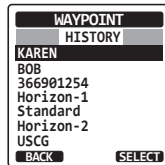
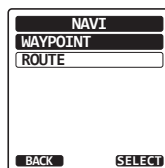
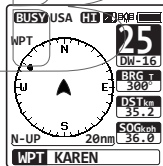
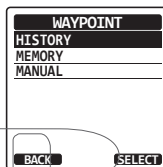

Navigation by Manually Entering a Waypoint

1. Press the **MENU** key to display “MENU”.
2. Select “NAVI” with the **CH▼/CH▲/◀/▶** key, then press the **[SELECT]** soft key.
3. Select “WAYPOINT” with the **CH▼/CH▲** key, then press the **[SELECT]** soft key.
4. Select “MANUAL” with the **CH▼/CH▲** key, then press the **[SELECT]** soft key.
5. If you want to give the waypoint an easy-to-find name, select “NAME” with the **CH▼/CH▲** key, press the **[SELECT]** soft key, then enter the name. For details, refer to “**10.5.1 Setting up the Individual / Position Call Directory**”.
6. Select “POSITION” with the **CH▼/CH▲** key, then press the **[SELECT]** soft key.
7. Press the **CH▼/CH▲/◀/▶** key to select the first number of latitude, then press the **[SELECT]** soft key to step to the next number.
8. Repeat step 7 to set the position.
If a mistake was made, press the **CH▼/CH▲/◀/▶** key to select “←” or “→”, press the **[SELECT]** soft key until the wrong character is selected, then perform step 7.
9. When finished programming the position, press the **[FINISH]** soft key. The display will return to the previous screen.
10. Select “SAVE & GO” with the **CH▼/CH▲** key, then press the **[SELECT]** soft key. The navigation screen will appear.
The screen includes the distance and direction to the destination, and the waypoint is indicated by a dot (●) inside the compass.
11. Press **◀/▶** key, then press the **[STOP]** soft key to stop the navigation.

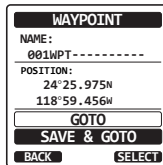
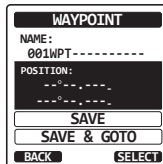
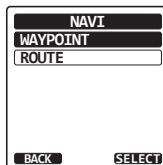
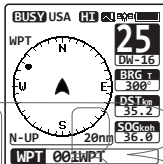
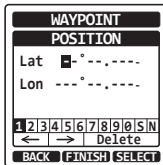
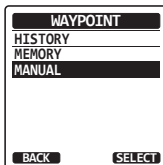

11.1.2 Setting Up Waypoint Directory

Marking a Position

This feature allows the radio to mark the current position of the vessel.

1. Press the **MENU** key to display “MENU”.
2. Select “SETUP” with the **CH▼/CH▲/◀/▶** key, then press the **[SELECT]** soft key.
3. Press the **CH▼/CH▲** key to select “WAYPOINT SETUP”, then press the **[SELECT]** soft key.
4. Select “MARK POSITION” with the **CH▼/CH▲** key, then press the **[SELECT]** soft key.
5. Select “NAME” with the **CH▼/CH▲** key, then press the **[SELECT]** soft key.
6. Enter the waypoint name by pressing the **CH▼/CH▲** key and the **[SELECT]** soft key. When finished entering the name, press the **[FINISH]** soft key.
7. If you want to modify the position, select “POSITION” with the **CH▼/CH▲** key, press the **[SELECT]** soft key, then enter the new coordinates. When finished modifying the position, press the **[FINISH]** soft key.
8. Select “SAVE” with the **CH▼/CH▲** key, then press the **[SELECT]** soft key to save the mark position into memory.
9. Press the **CLR** key to return to radio operation.

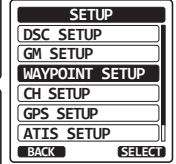
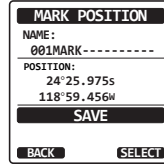
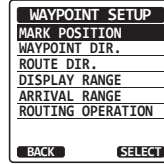
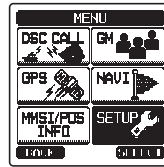

Adding a Waypoint

1. Press the **MENU** key to display “MENU”.
2. Select “SETUP” with the **CH▼/CH▲/◀/▶** key, then press the **[SELECT]** soft key.
3. Press the **CH▼/CH▲** key to select “WAYPOINT SETUP”, then press the **[SELECT]** soft key.
4. Select “WAYPOINT DIR.” with the **CH▼/CH▲** key, then press the **[SELECT]** soft key.
5. Select “ADD” with the **CH▼/CH▲** key, then press the **[SELECT]** soft key.
6. Select “NAME” with the **CH▼/CH▲** key, then press the **[SELECT]** soft key.
7. Enter the waypoint name by pressing the **CH▼/CH▲** key and the **[SELECT]** soft key. When finished entering the name, press the **[FINISH]** soft key.

8. Select “POSITION” with the **CH▼/CH▲** key, press the **[SELECT]** soft key, then enter the coordinates.

When finished entering the position, press the **[FINISH]** soft key.

9. Select “SAVE” with the **CH▼/CH▲** key, then press the **[SELECT]** soft key to save the waypoint into memory.
10. Press the **CLR** key to return to radio operation.

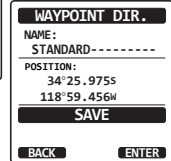
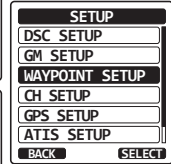
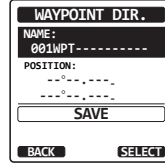
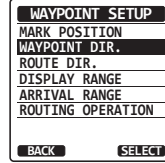

Editing a Waypoint

This function allows a previously entered waypoint to be edited.

1. Press the **MENU** key to display “MENU”.
2. Select “SETUP” with the **CH▼/CH▲/◀/▶** key, then press the **[SELECT]** soft key.
3. Press the **CH▼/CH▲** key to select “WAYPOINT SETUP”, then press the **[SELECT]** soft key.
4. Press the **CH▼/CH▲** key to select “WAYPOINT DIR.”, then press the **[SELECT]** soft key.
5. Select “EDIT” with the **CH▼/CH▲** key, then press the **[SELECT]** soft key.
6. Press the **CH▼/CH▲** key to select the waypoint to be edited, then press the **[SELECT]** soft key to show the waypoint input display.
7. Select “NAME” or “POSITION” with the **CH▼/CH▲** key, then press the **[SELECT]** soft key.
8. Press the **CH▼/CH▲/◀/▶** key to select “←” or “→”, press the **[SELECT]** soft key until the character to be changed is selected, then enter a new character.
9. Repeat step 8 until the waypoint is updated.
When finished editing, press the **[FINISH]** soft key.
10. Select “SAVE” with the **CH▼/CH▲** key, then press the **[SELECT]** soft key to store the edited waypoint into memory.
11. Press the **CLR** key to return to radio operation.

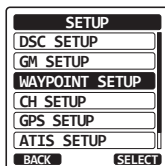
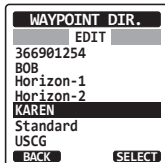
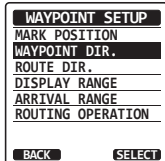

Deleting a Waypoint

1. Press the **MENU** key to display “MENU”.
2. Select “SETUP” with the **CH▼/CH▲/◀/▶** key, then press the **[SELECT]** soft key.
3. Press the **CH▼/CH▲** key to select “WAYPOINT SETUP”, then press the **[SELECT]** soft key.
4. Press the **CH▼/CH▲** key to select “WAYPOINT DIR.”, then press the **[SELECT]** soft key.
5. Select “DELETE” with the **CH▼/CH▲** key, then press the **[SELECT]** soft key.
6. Press the **CH▼/CH▲** key to select the waypoint to be deleted, then press the **[SELECT]** soft key.
7. Confirm the waypoint to be deleted, select “OK” with the **CH▼/CH▲** key, then press the **[ENTER]** soft key.

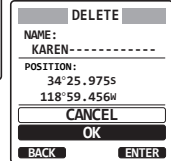
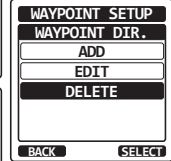
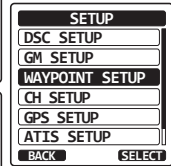
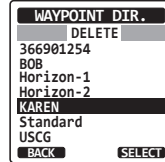
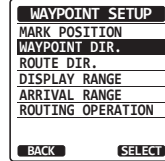

8. Press the **CLR** key to return to radio operation.

Saving a DSC Position Call as a Waypoint

When a position is received from another DSC radio the **HX870** allows the position to be saved as a waypoint.

Refer to section “**10.8.4 Saving a Position Report as a Waypoint**” for details.

11.1.3 Selecting the Display Range

This menu item allows setting of the range on the compass display.

1. Press the **MENU** key to display “MENU”.
2. Select “SETUP” with the **CH▼/CH▲/◀/▶** key, then press the **[SELECT]** soft key.
3. Press the **CH▼/CH▲** key to select “WAYPOINT SETUP”, then press the **[SELECT]** soft key.
4. Select “DISPLAY RANGE” with the **CH▼/CH▲/◀/▶** key, then press the **[SELECT]** soft key.
5. Press the **CH▼/CH▲** key to select desired range. (Unit of measure depends on the settings in the GPS SETUP menu.)
6. Press the **[ENTER]** soft key to store the selected setting.
7. Press the **CLR** key to return to radio operation.

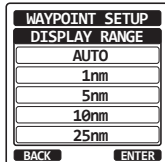
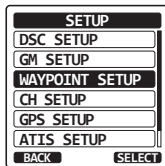
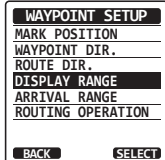
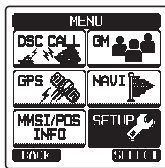

11.1.4 Selecting the Arrival Range

This menu item allows setting of the range within which the **HX870** determines to be around the destination.

1. Press the **MENU** key to display “MENU”.
2. Select “SETUP” with the **CH▼/CH▲/◀/▶** key, then press the **[SELECT]** soft key.
3. Press the **CH▼/CH▲** key to select “WAYPOINT SETUP”, then press the **[SELECT]** soft key.
4. Select “ARRIVAL RANGE” with the **CH▼/CH▲/◀/▶** key, then press the **[SELECT]** soft key.
5. Press the **CH▼/CH▲** key to select desired range. (Unit of measure depends on the settings in the GPS SETUP menu.)
6. Press the **[ENTER]** soft key to store the selected setting.
7. Press the **CLR** key to return to radio operation.

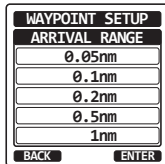
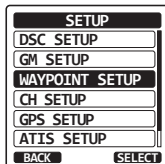
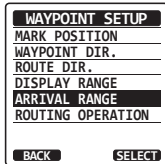
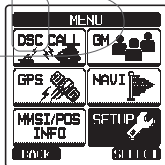

11.2 ROUTING OPERATION

The **HX870** allows you to set 1 to 15 waypoints along the route.

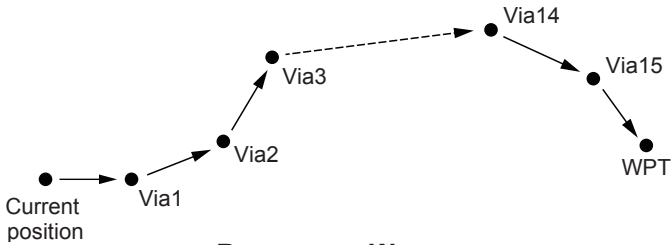

ROUTING TO A WAYPOINT

11.2.1 Setting Up Routing Directory

NOTE

All the destinations and via-points must be programmed as waypoints in the **HX870** memory. Refer to section “11.1.2 Setting Up Waypoint Directory”.

Adding a Route

1. Press the **MENU** key to display “MENU”.
2. Select “SETUP” with the **CH▼/CH▲/◀/▶** key, then press the **[SELECT]** soft key.
3. Press the **CH▼/CH▲** key to select “WAYPOINT SETUP”, then press the **[SELECT]** soft key.
4. Select “ROUTE DIR.” with the **CH▼/CH▲** key, then press the **[SELECT]** soft key.
5. Select “ADD” with the **CH▼/CH▲** key, then press the **[SELECT]** soft key.
6. Select “NAME” with the **CH▼/CH▲** key, then press the **[SELECT]** soft key.
7. Enter the route name by pressing the **CH▼/CH▲** key and the **[SELECT]** soft key. When finished entering the name, press the **[FINISH]** soft key.

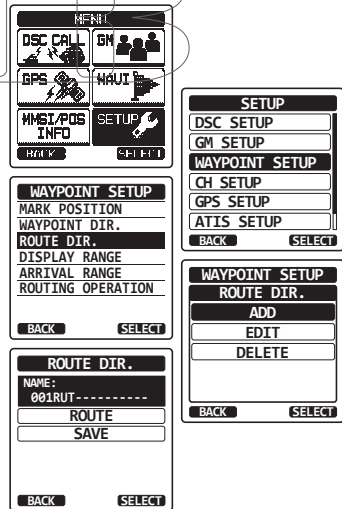

8. Select "ROUTE" with the **CH▼/CH▲** key, press the **[SELECT]** soft key.
9. Select "WPT" with the **CH▼/CH▲** key, then press the **[SELECT]** soft key.
10. Press the **CH▼/CH▲** key to select a waypoint, then press the **[SELECT]** soft key.
11. Select "Via1" with the **CH▼/CH▲** key, then press the **[SELECT]** soft key.
12. Press the **CH▼/CH▲** key to select a waypoint, then press the **[SELECT]** soft key.
13. Repeat steps 11 and 12 to add more via-points.
14. Press the **[BACK]** soft key.
15. Select "SAVE" with the **CH▼/CH▲** key, then press the **[SELECT]** soft key to store the route into memory.
16. Press the **CLR** key to return to radio operation.

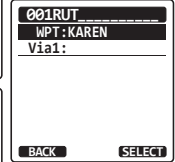
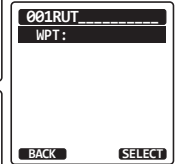
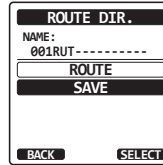
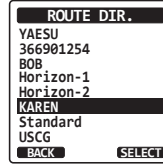
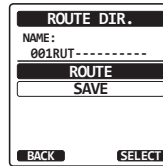

Editing a Route

This function allows a previously entered route to be edited.

1. Press the **MENU** key to display "MENU".
2. Select "SETUP" with the **CH▼/CH▲/◀/▶** key, then press the **[SELECT]** soft key.
3. Press the **CH▼/CH▲** key to select "WAYPOINT SETUP", then press the **[SELECT]** soft key.
4. Press the **CH▼/CH▲** key to select "ROUTE DIR.", then press the **[SELECT]** soft key.
5. Select "EDIT" with the **CH▼/CH▲** key, then press the **[SELECT]** soft key.
6. Press the **CH▼/CH▲** key to select the route to be edited, then press the **[SELECT]** soft key to show the route input display.
7. Perform steps 6 to 14 of the previous page until the route is updated.
8. Select "SAVE" with the **CH▼/CH▲** key, then press the **[SELECT]** soft key to store the edited route into memory.
9. Press the **CLR** key to return to radio operation.

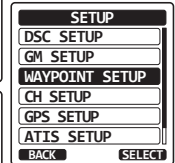
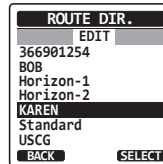
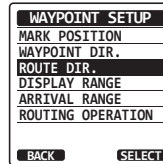
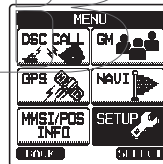

Deleting a Route

1. Press the **MENU** key to display “MENU”.
2. Select “SETUP” with the **CH▼/CH▲/◀/▶** key, then press the **[SELECT]** soft key.
3. Press the **CH▼/CH▲** key to select “WAYPOINT SETUP”, then press the **[SELECT]** soft key.
4. Press the **CH▼/CH▲** key to select “ROUTE DIR.”, then press the **[SELECT]** soft key.
5. Select “DELETE” with the **CH▼/CH▲** key, then press the **[SELECT]** soft key.
6. Press the **CH▼/CH▲** key to select the route to be deleted, then press the **[SELECT]** soft key.
7. Confirm the route to be deleted, select “OK” with the **CH▼/CH▲** key, then press the **[ENTER]** soft key.

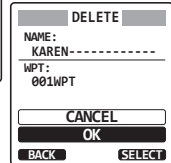
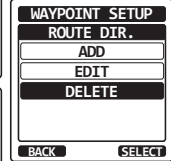
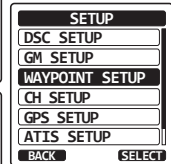
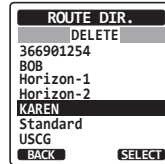
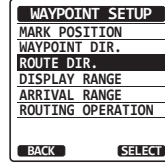

8. Press the **CLR** key to return to radio operation.

11.2.2 Starting and Stopping Route Navigation

1. Press the **MENU** key to display “MENU”.
2. Select “NAVI” with the **CH▼/CH▲/◀/▶** key, then press the **[SELECT]** soft key.
3. Select “ROUTE” with the **CH▼/CH▲** key, then press the **[SELECT]** soft key.
4. Select the desired category (“HISTORY” or “MEMORY”), then press the **[SELECT]** soft key.
5. Press the **CH▼/CH▲** key to select a route, then press the **[SELECT]** soft key. The navigation screen with “RTE” indicator appears.
6. A message “ARRIVED” will appear when you have reached to the first target point.
To start navigation to the next target, press the **[YES]** soft key.
7. To stop the navigation, press **◀/▶** key, then press the **[STOP]** soft key.
8. Press the **CLR** key to return to radio operation.

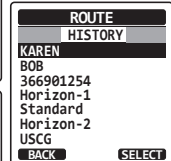
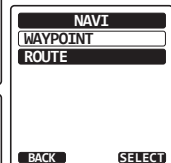
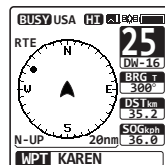
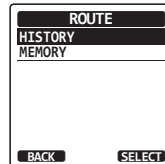
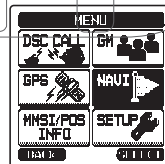

11.2.3 Changing the Destination

1. On the navigation screen, press ◀/▶ key, then press the [NEXT TG] soft key.
2. Press the CH▼/CH▲ key to select desired destination.
3. Press the [SELECT] soft key. The navigation screen with a new destination appears.

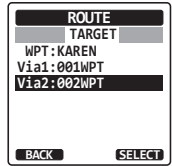
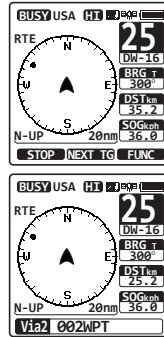

11.2.4 Selecting Automatic or Manual Routing

This selection allows you to start navigation to the next target automatically or manually when your vessel has arrived at a target point.

1. Press the MENU key to display “MENU”.
2. Select “SETUP” with the CH▼/CH▲/◀/▶ key, then press the [SELECT] soft key.
3. Press the CH▼/CH▲ key to select “WAYPOINT SETUP”, then press the [SELECT] soft key.
4. Press the CH▼/CH▲ key to select “ROUTE OPERATION”, then press the [SELECT] soft key.
5. Select “AUTO” or “MANUAL” with the CH▼/CH▲ key, then press the [ENTER] soft key.
6. Press the CLR key to return to radio operation.

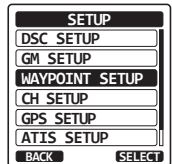
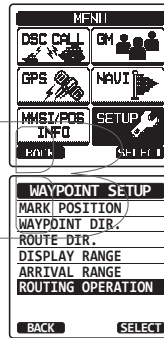

12 GM OPERATION

The GM (Group Monitor) feature of the **HX870** utilizes the same system as the DSC Group call and Auto Position Polling, to display the group members' locations.

12.1 SETTING UP GM OPERATION

The **HX870** is capable of storing up to 10 groups with 1 to 9 members each.

12.1.1 Setting Up Group Directory

NOTE

- For this function to operate, the same group MMSI must be programmed into each transceiver of group members to be monitored. Refer to section “**10.6.1 Setting Up a Group Call**” for details.
- Group members for GM operation can only be selected from the Individual/Position Call directory, there for all members that you want to monitor have to be stored in the directory. Refer to section “**10.5.1 Setting Up the Individual / Position Call Directory**” for details.

1. Press the **MENU** key to display “MENU”.
2. Press the **CH▼/CH▲/◀/▶** key to select “SETUP”, then press the **[SELECT]** soft key.
3. Select “GM SETUP” with the **CH▼/CH▲** key, then press the **[SELECT]** soft key.
4. Select “GM GROUP DIR.” with the **CH▼/CH▲** key, then press the **[SELECT]** soft key.
5. Select “ADD” with the **CH▼/CH▲** key, then press the **[SELECT]** soft key.
6. Select “NAME” with the **CH▼/CH▲** key, then press the **[SELECT]** soft key.
7. Enter the route name by pressing the **CH▼/CH▲** key and the **[SELECT]** soft key. When finished entering the name, press the **[FINISH]** soft key.
8. Select “GM ID” with the **CH▼/CH▲** key, press the **[SELECT]** soft key, then enter the group MMSI number. When finished entering the MMSI, press the **[FINISH]** soft key.

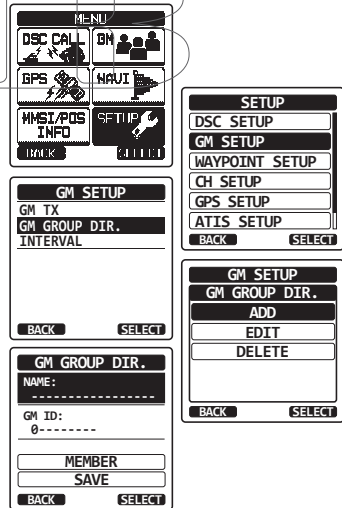

9. Select "MEMBER" with the **CH▼/CH▲** key, then press the **[SELECT]** soft key.
10. Press the **CH▼/CH▲** key to select a list number, then press the **[SELECT]** soft key.
11. Press the **CH▼/CH▲** key to select a member from the Individual directory, then press the **[SELECT]** soft key.
12. Repeat steps 11 and 11 to add members to the group.
13. Press the **[BACK]** soft key to return to the "NAME" and "GM ID" screen.
14. To store the data, select "SAVE" with the **CH▼/CH▲** key, then press the **[ENTER]** soft key.
15. To enter another group directories, repeat steps 5 through 14.
16. Press the **CLR** key to return to radio operation.

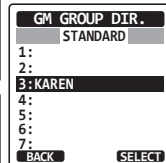
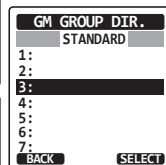
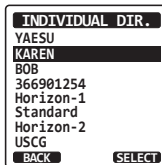

12.1.2 Setting Up the Polling Time Interval

1. Press the **MENU** key to display "MENU".
2. Press the **CH▼/CH▲/◀/▶** key to select "SETUP", then press the **[SELECT]** soft key.
3. Select "GM SETUP" with the **CH▼/CH▲** key, then press the **[SELECT]** soft key.
4. Select "INTERVAL" with the **CH▼/CH▲** key, then press the **[SELECT]** soft key.
5. Press the **CH▼/CH▲** key to select the desired interval time, then press the **[ENTER]** soft key.
6. Press the **CLR** key to return to radio operation.

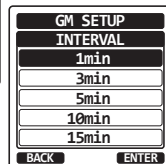
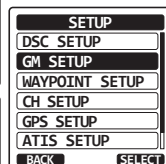
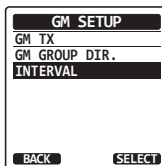

12.1.3 Enabling/Disabling Transmission during GM Operation

1. Press the **MENU** key to display “MENU”.
2. Press the **CH▼/CH▲/◀/▶** key to select “SETUP”, then press the **[SELECT]** soft key.
3. Select “GM SETUP” with the **CH▼/CH▲** key, then press the **[SELECT]** soft key.
4. Select “GM TX” with the **CH▼/CH▲** key, then press the **[SELECT]** soft key.
5. Press the **CH▼/CH▲** key to select the desired transmission type, then press the **[ENTER]** soft key.
 - OFF: Disables the transmission during GM operation.
 - ON GM: Enables the transmission during the GM target display.
 - ON ALL: Enables the transmission during the GM operation.
6. Press the **CLR** key to return to radio operation.

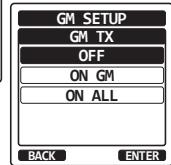
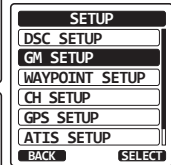
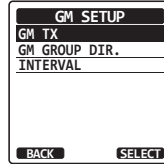
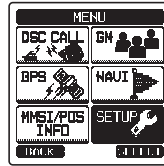

12.2 STARTING GM OPERATION

1. Press the **MENU** key to display “MENU”.
2. Press the **CH▼/CH▲/◀/▶** key to select “GM”, then press the **[SELECT]** soft key.
3. Select a group you want to monitor with the **CH▼/CH▲** key, then press the **[SELECT]** soft key.

The GM operation starts and the GM target display appears.
4. Press the **CLR** key to return to radio operation.

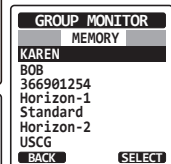
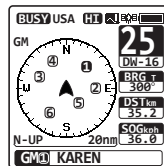
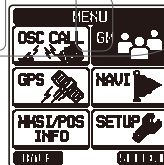

12.2.1 Transmitting a DSC Call to a Group Member

1. Press **◀/▶** key during the GM target display, then press the **[LIST]** soft key.
2. Press the **CH▼/CH▲** key to select a member you want to call.
3. Press the **[SELECT]** soft key.
The list number of the selected member will be highlighted, and the name of the selected member will be displayed at the bottom of the screen.
4. Press **◀/▶** key, then press the **[CALL]** soft key to transmit a DSC Individual call to the selected member.

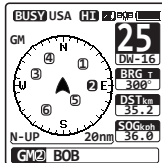
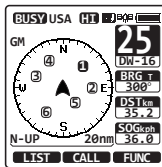

GM KARENS	
NAME	DST MH
1: KAREN	35.2
2: BOB	11.0
3: 366901254	12.8
4: Horizon	34.9
5: Standard	30.0
6: Horizon-2	47.6
7: MIKE	38.4

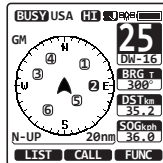

12.2.2 Starting Navigation to a Group Member

1. Press **◀/▶** key during the GM target display, then press the **[LIST]** soft key.
2. Press the **CH▼/CH▲** key to select a member you want to approach.
3. Press the **[INFO]** soft key to display the location, distance, and bearing of the selected member.
4. Press the **[TO WPT]** soft key to start navigation to the selected member. (Press the **[BACK]** soft key twice to cancel and return to the GM target display.)

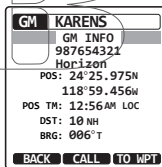
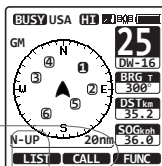

GM KARENS	
NAME	DST MH
1: KAREN	35.2
2: BOB	11.0
3: 366901254	12.8
4: Horizon	34.9
5: Standard	30.0
6: Horizon-2	47.6
7: MIKE	38.4

13 CONFIGURATION SETUP

13.1 DIMMER ADJUSTMENT

This menu selection adjusts the backlight intensity.

1. Press the **MENU** key to display “MENU”.
2. Select “SETUP” with the **CH▼/CH▲/◀/▶** key, then press the **[SELECT]** soft key.
3. Select “CONFIGURATION” with the **CH▼/CH▲** key, then press the **[SELECT]** soft key.
4. Select “DIMMER” with the **CH▼/CH▲** key, then press the **[SELECT]** soft key.
5. Press the **CH▼/CH▲** key to select the desired level (“5” is default). When “OFF” is selected, the lamp is turned off.
6. Press the **[ENTER]** soft key to store the selected level.
7. Press the **CLR** key to return to radio operation.

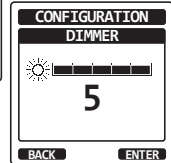
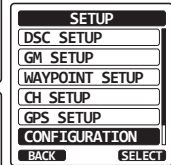
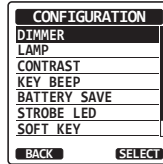

13.2 LAMP

This menu selection is used to setup the illumination time of the display and keypad.

1. Press the **MENU** key to display “MENU”.
2. Select “SETUP” with the **CH▼/CH▲/◀/▶** key, then press the **[SELECT]** soft key.
3. Select “CONFIGURATION” with the **CH▼/CH▲** key, then press the **[SELECT]** soft key.
4. Select “LAMP” with the **CH▼/CH▲** key, then press the **[SELECT]** soft key.
5. Press the **CH▼/CH▲** key to select the desired time.

OFF: Disables the display/keypad lamp illumination.

3/5/10 Sec: Illuminates the display/keypad for the selected time when you press any key (except the PTT switch).

CONTINUOUS: Illuminates the display/keypad continuously.

6. Press the **[ENTER]** soft key to store the selected setting.
7. Press the **CLR** key to return to radio operation.

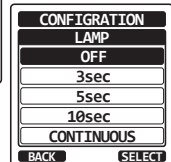
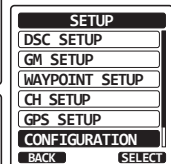
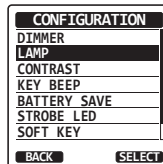
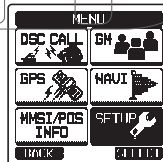

13.3 DISPLAY CONTRAST

The display contrast can be adjusted to suit your operation environment.

1. Press the **MENU** key to display “MENU”.
2. Select “SETUP” with the **CH▼/CH▲/◀/▶** key, then press the **[SELECT]** soft key.
3. Select “CONFIGURATION” with the **CH▼/CH▲** key, then press the **[SELECT]** soft key.
4. Select “CONTRAST” with the **CH▼/CH▲** key, then press the **[SELECT]** soft key.
5. Press the **CH▼/CH▲** key to select the desired level. The contrast level can be set from “0” to “30” (“10” is default).
6. Press the **[ENTER]** soft key to store the selected level.
7. Press the **CLR** key to return to radio operation.

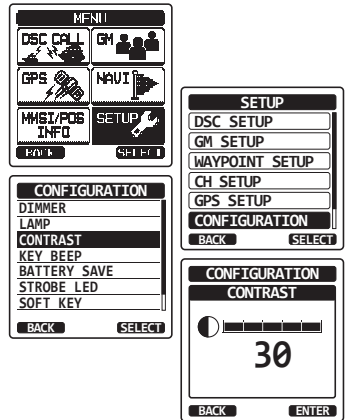

13.4 KEY BEEP

This selection is used to select the beep tone volume level when a key is pressed.

1. Press the **MENU** key to display “MENU”.
2. Select “SETUP” with the **CH▼/CH▲/◀/▶** key, then press the **[SELECT]** soft key.
3. Select “CONFIGURATION” with the **CH▼/CH▲** key, then press the **[SELECT]** soft key.
4. Select “KEY BEEP” with the **CH▼/CH▲** key, then press the **[SELECT]** soft key.
5. Press the **CH▼/CH▲** key to select the desired level. The beep level can be set from “LEVEL 1” to “LEVEL 5”, or “OFF”.
6. Press the **[ENTER]** soft key to store the selected level.
7. Press the **CLR** key to return to radio operation.

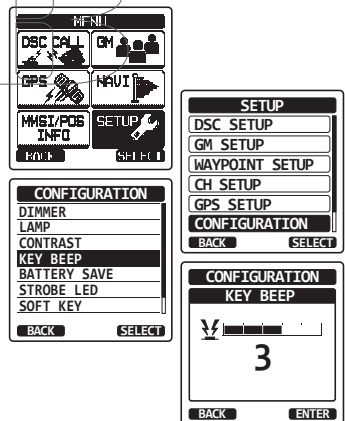

13.5 BATTERY SAVER

This function allows you to change the battery save mode setting.

1. Press the **MENU** key to display “MENU”.
2. Select “SETUP” with the **CH▼/CH▲/◀/▶** key, then press the **[SELECT]** soft key.
3. Select “CONFIGURATION” with the **CH▼/CH▲** key, then press the **[SELECT]** soft key.
4. Select “BATTERY SAVE” with the **CH▼/CH▲** key, then press the **[SELECT]** soft key.
5. Press the **CH▼/CH▲** key to select the desired setting. You can select one from “OFF”, “50%”, “70%”, “80%”, or “90%”.
6. Press the **[ENTER]** soft key to store the selected setting.
7. Press the **CLR** key to return to radio operation.

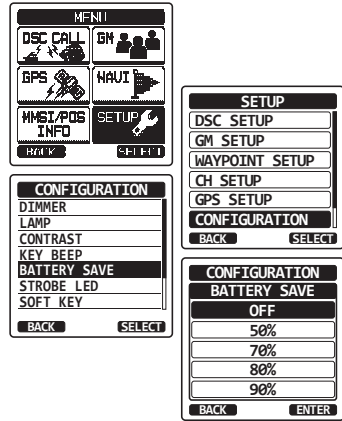

13.6 STROBE LED

This selection is used to switch and set the function of the strobe LED.

13.6.1 Emergency LED

1. Press the **MENU** key to display “MENU”.
2. Select “SETUP” with the **CH▼/CH▲/◀/▶** key, then press the **[SELECT]** soft key.
3. Select “CONFIGURATION” with the **CH▼/CH▲** key, then press the **[SELECT]** soft key.
4. Select “STROBE LED” with the **CH▼/CH▲** key, then press the **[SELECT]** soft key.
5. Press the **CH▼/CH▲** key to select “EMERGENCY LED”, then press the **[SELECT]** soft key.
6. Press the **CH▼/CH▲** key to select the desired setting. You can select one from “CONTINUOUS”, “SOS”, “BLINK 1”, “BLINK 2”, or “BLINK 3”.
7. Press the **[ENTER]** soft key to store the selected setting.
8. Press the **CLR** key to return to radio operation.

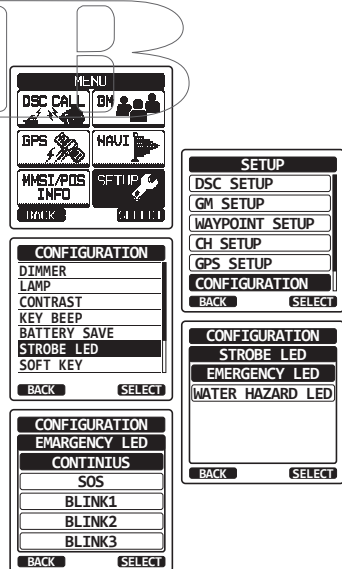

13.6.2 Water Hazard LED

1. Press the **MENU** key to display “MENU”.
2. Select “SETUP” with the **CH▼/CH▲/◀/▶** key, then press the **[SELECT]** soft key.
3. Select “CONFIGURATION” with the **CH▼/CH▲** key, then press the **[SELECT]** soft key.
4. Select “STROBE LED” with the **CH▼/CH▲** key, then press the **[SELECT]** soft key.
5. Press the **CH▼/CH▲** key to select “WATER HAZARD LED”, then press the **[SELECT]** soft key.
6. Press the **CH▼/CH▲** key to select the desired setting. You can select one from “OFF”, “ON”, or “ON/PWR ON”.

OFF: The LED does not light up.

ON: The LED lights up.

ON/PWR ON: The LED lights up and the transceiver turns on even if the transceiver is off.

7. Press the **[ENTER]** soft key to store the selected setting.
8. Press the **CLR** key to return to radio operation.

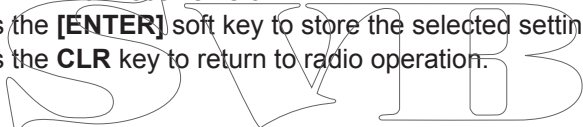
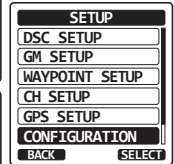
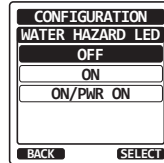
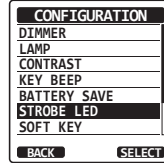

13.7 SOFT KEYS

This menu item allows soft key assignment and how long the display will show the soft key icon after a soft key is pressed.

13.7.1 Key Assignment

1. Press the **MENU** key to display “MENU”.
2. Select “SETUP” with the **CH▼/CH▲/◀/▶** key, then press the **[SELECT]** soft key.
3. Select “CONFIGURATION” with the **CH▼/CH▲** key, then press the **[SELECT]** soft key.
4. Select “SOFT KEY” with the **CH▼/CH▲** key, then press the **[SELECT]** soft key.
5. Select “KEY ASSIGNMENT” with the **CH▼/CH▲** key, then press the **[SELECT]** soft key.
6. Press the **CH▼/CH▲** key to select the key number to be programmed, and press the **[SELECT]** soft key.
7. Press the **CH▼/CH▲** key to select a new function to be assigned, and press the **[ENTER]** soft key. Available functions are listed below. By selecting “NONE” the soft key assignment is removed.
8. Repeat steps 6 and 7 to program other soft keys. Up to 12 functions can be assigned.
9. Press the **CLR** key to return to radio operation.

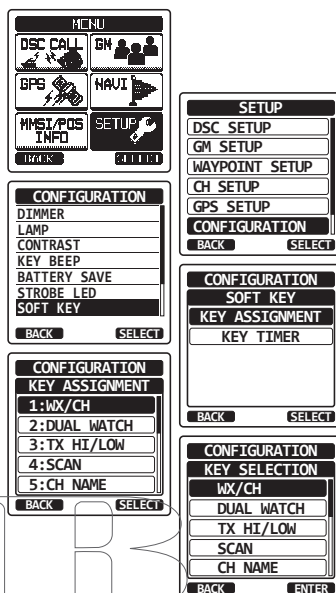

DISPLAY	FUNCTION
WX/CH	Switches channels between weather and marine.
HI/MD/LO	Selects transmit power.
SCAN	Turns on or off scanning function.
DW/TW	Turns on or off dual or triple watch scan.
MOB	Marks the position where a person falls overboard.
COMP	Enables the “Compass” display.
NAVI	Enables the “Waypoint” or “Route” navigation display.
MARK	Marks the current position for a “Waypoint”.
MEM	Add or remove channels from memory channel scan.
PRESET	Programs or deletes the preset memory channel.
NAME	Edit channel names.
STROBE	Turns on or off the strobe light LED.
LOGGER	Starts and stops logging position data.
NCR	Enables the noise canceling settings display.

13.7.2 Key Timer

1. Press the **MENU** key to display "MENU".
2. Select "SETUP" with the **CH▼/CH▲/◀/▶** key, then press the **[SELECT]** soft key.
3. Select "CONFIGURATION" with the **CH▼/CH▲** key, then press the **[SELECT]** soft key.
4. Select "SOFT KEY" with the **CH▼/CH▲** key, then press the **[SELECT]** soft key.
5. Select "KEY TIMER" with the **CH▼/CH▲** key, then press the **[SELECT]** soft key.
6. Press the **CH▼/CH▲** key to select the desired time.
7. Press the **[ENTER]** soft key to store the selected setting.
8. Press the **CLR** key to return to radio operation.

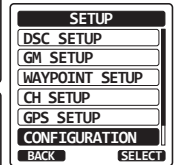
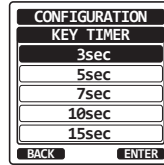
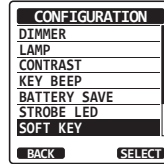
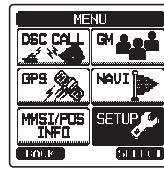

13.8 RESET

You may initialize the memories and settings of the setup categories independently or return the transceiver to the original factory setting.

1. Press the **MENU** key to display "MENU".
2. Select "SETUP" with the **CH▼/CH▲/◀/▶** key, then press the **[SELECT]** soft key.
3. Select "CONFIGURATION" with the **CH▼/CH▲** key, then press the **[SELECT]** soft key.
4. Select "RESET" with the **CH▼/CH▲** key, then press the **[SELECT]** soft key.
5. Press the **CH▼/CH▲** key to select the desired category. You can select one from "DSC", "CHANNEL", "WAYPOINT & GPS", "CONFIGURATION", or "FACTORY" (all settings except the MMSI will be initialized).
7. Press the **[ENTER]** soft key to store the selected setting.
8. Press the **CLR** key to return to radio operation.

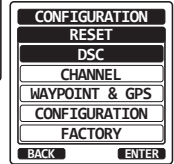
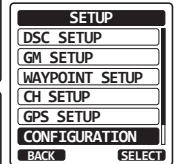
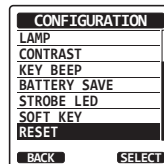
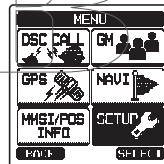

13.9 SUMMARY OF THE CONFIGURATION SETUP

Item	Description	Default Value
DIMMER	Adjusts the backlight level of the LCD and keypad	5
LAMP	Selects the illumination time of the LCD and keypad backlights.	3 sec
CONTRAST	Adjusts the contrast of the LCD	10
KEY BEEP	Adjusts the volume of beep tone when a key is pressed.	3
BATTERY SAVE	Selects the battery save mode.	50%
STROBE LED	Sets the operation of the EMERGENCY LED.	CONTINUOUS
	Sets the operation of the WATER HAZARD LED.	ON
SOFT KEY KEY TIMER	Sets the assignment and display time of the soft keys.	10 sec
RESET	Initializes the memories and settings.	-

SVIB

14 CHANNEL FUNCTION SETUP

14.1 CHANNEL GROUP

This menu item allows you to select a channel group from USA, Canada, and International.

Refer to section “8.6 USA, INTERNATIONAL, AND CANADA MODE” for details.

14.2 WEATHER ALERT

Enables/disables the NOAA Weather Alert function. The default setting is “ON”.

1. Press the **MENU** key to display “MENU”.
2. Select “SETUP” with the **CH▼/CH▲/◀/▶** key, then press the **[SELECT]** soft key.
3. Select “CH SETUP” with the **CH▼/CH▲** key, then press the **[SELECT]** soft key.
4. Select “WX ALERT” with the **CH▼/CH▲** key, then press the **[SELECT]** soft key.
5. Press the **CH▼/CH▲** key to select “ON” or “OFF”.
6. Press the **[ENTER]** soft key to store the selected level.
7. Press the **CLR** key to return to radio operation.

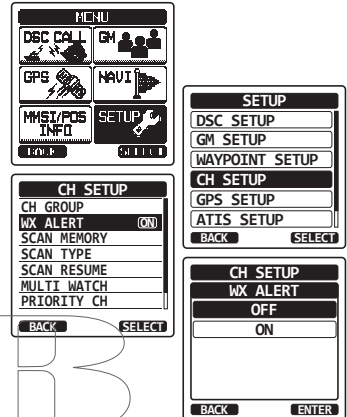

14.3 SCAN MEMORY

To be able to scan channels the radio must be programmed. This section allows channels to be stored in scan memory.

Refer to section “8.9.2 Programming Scan Memory” for details.

14.4 SCAN TYPE

This selection is used to select the scan mode between “Memory Scan” and “Priority Scan”. The default setting is “Priority Scan”.

Refer to section “8.9.1 Selecting the Scan Type” for details.

14.5 SCAN RESUME

This selection is used to select the time the **HX870** waits after a transmission ends before the radio starts to scan channels again. The default setting is 2 seconds.

1. Press the **MENU** key to display “MENU”.
2. Select “SETUP” with the **CH▼/CH▲/◀/▶** key, then press the **[SELECT]** soft key.
3. Select “CH SETUP” with the **CH▼/CH▲** key, then press the **[SELECT]** soft key.
4. Select “SCAN RESUME” with the **CH▼/CH▲** key, then press the **[SELECT]** soft key.
5. Press the **CH▼/CH▲** key to select the desired resume time, default is 2 seconds. The resume time can be set to “1sec” through “5sec”.
6. Press the **[ENTER]** soft key to store the new setting.
7. Press the **CLR** key to return to radio operation.

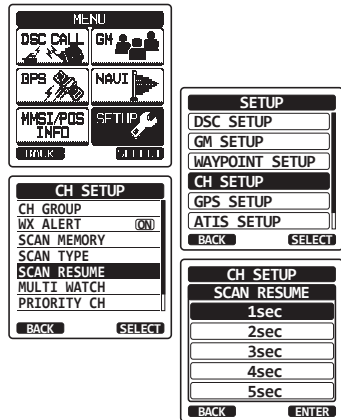

14.6 WATCH TYPE

This selection is used to select the watch type between “Dual Watch” and “Triple Watch”. The default setting is “Dual Watch”.

Refer to section “**8.8 MULTI WATCH (TO PRIORITY CHANNEL)**” for details.

14.7 PRIORITY CHANNEL

This procedure allows the radio to use a different priority channel GPS used when priority scanning. By default the radio priority channel is set to Channel 16.

1. Press the **MENU** key to display “MENU”.
2. Select “SETUP” with the **CH▼/CH▲/◀/▶** key, then press the **[SELECT]** soft key.
3. Select “CH SETUP” with the **CH▼/CH▲** key, then press the **[SELECT]** soft key.
4. Select “PRIORITY CH” with the **CH▼/CH▲** key, then press the **[SELECT]** soft key.
5. Press the **CH▼/CH▲** key to select the desired channel to be a priority.
6. Press the **[ENTER]** soft key to store the new setting.
7. Press the **CLR** key to return to radio operation.

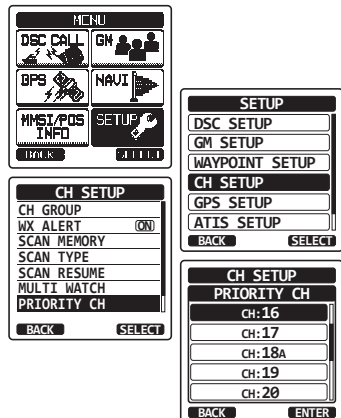

14.8 SUB CHANNEL

By default the sub channel is set to Channel 9. This procedure allows the radio to assign a different sub channel for instant access.

1. Press the **MENU** key to display “MENU”.
2. Select “SETUP” with the **CH▼/CH▲/◀/▶** key, then press the **[SELECT]** soft key.
3. Select “CH SETUP” with the **CH▼/CH▲** key, then press the **[SELECT]** soft key.
4. Select “SUB CH” with the **CH▼/CH▲** key, then press the **[SELECT]** soft key.
5. Press the **CH▼/CH▲** key to select the desired channel to be a sub channel.
6. Press the **[ENTER]** soft key to store the new setting.
7. Press the **CLR** key to return to radio operation.

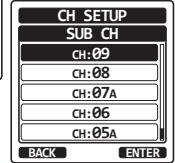
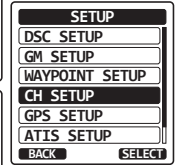
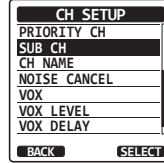

SVIB

14.9 CHANNEL NAME

When the radio (“Normal”) mode is selected, the display will show a name under the channel number. This name describes the use of the channel. The radio has the capability to customize the name by the procedure below.

Example: CH69 PLEASURE to HOOKUP

1. Press the **MENU** key to display “MENU”.
2. Select “SETUP” with the **CH▼/CH▲/◀/▶** key, then press the **[SELECT]** soft key.
3. Select “CH SETUP” with the **CH▼/CH▲** key, then press the **[SELECT]** soft key.
4. Select “CH NAME” with the **CH▼/CH▲** key, then press the **[SELECT]** soft key.
5. Press the **CH▼/CH▲** key to select the channel to be named, then press the **[SELECT]** soft key.
6. Press the **CH▼/CH▲** key to scroll through the first letter of the new channel name.
7. Press the **[SELECT]** soft key to store the first letter in the name and step to the next letter to the right.
8. Repeat step 6 and 7 until the name is complete. The name can consist of up to 16 characters, if you do not use all 16 characters, select “→” to move to the next space. This method can also be used to enter a blank space in the name.
9. Press the **[FINISH]** soft key to save the name.
10. If you want to enter the name of another channel, repeat the steps 5 through 9.
11. Press the **CLR** key to return to radio operation.

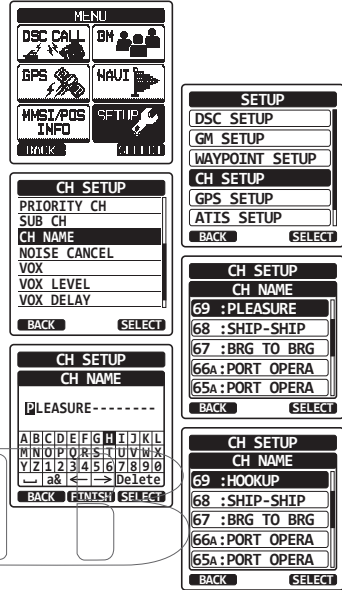

NOTE

When “CHANNEL NAME” is assigned to the soft key, you can show the channel name input display directly by pressing the **[NAME]** soft key during radio operation.

14.10 NOISE CANCELLATION

Enables/disables the Noise-canceling function of the transmitter and receiver independently.

1. Press the **MENU** key to display “MENU”.
2. Select “SETUP” with the **CH▼/CH▲/◀/▶** key, then press the **[SELECT]** soft key.
3. Select “CH SETUP” with the **CH▼/CH▲** key, then press the **[SELECT]** soft key.
4. Select “NOISE CANCEL” with the **CH▼/CH▲** key, then press the **[SELECT]** soft key.
5. Select “TX MODE” with the **CH▼/CH▲** key, then press the **[SELECT]** soft key.
6. Press the **CH▼/CH▲** key to select “ON” or “OFF”, then press the **[ENTER]** soft key.
7. Select “RX MODE” with the **CH▼/CH▲** key, then press the **[SELECT]** soft key.
8. Select the noise level from “Level 1” through “Level 4” or “OFF” with the **CH▼/CH▲** key, then press the **[ENTER]** soft key.

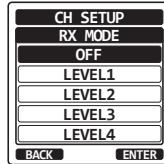
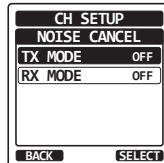
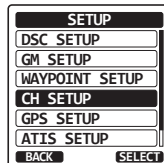
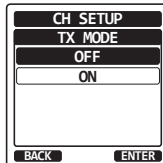
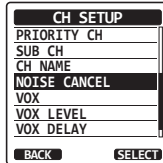
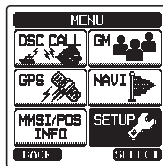

9. Press the **CLR** key to return to radio operation.

14.11 VOX OPERATION

The procedures below allow you to set up the VOX operation when utilizing an optional VOX headset purchased from a third party vendor.

14.11.1 Enabling the VOX Operation

1. Press the **MENU** key to display “MENU”.
2. Select “SETUP” with the **CH▼/CH▲/◀/▶** key, then press the **[SELECT]** soft key.
3. Select “CH SETUP” with the **CH▼/CH▲** key, then press the **[SELECT]** soft key.
4. Select “VOX” with the **CH▼/CH▲** key, then press the **[SELECT]** soft key.
5. Press the **CH▼/CH▲** key to select “ON” or “OFF”, then press the **[ENTER]** soft key to store the new setting.
6. Press the **CLR** key to return to radio operation.

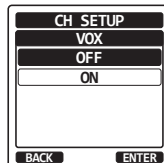
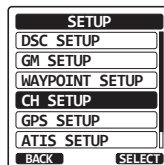
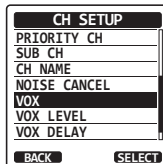
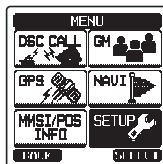

14.11.2 Setting the VOX Level

1. Press the **MENU** key to display "MENU".
2. Select "SETUP" with the **CH▼/CH▲/◀/▶** key, then press the **[SELECT]** soft key.
3. Select "CH SETUP" with the **CH▼/CH▲** key, then press the **[SELECT]** soft key.
4. Select "VOX LEVEL" with the **CH▼/CH▲** key, then press the **[SELECT]** soft key.
5. Press the **CH▼/CH▲** key to select the desired active level. The level can be set from "0" to "4" ("2" is default).
6. Press the **[ENTER]** soft key to store the new setting.
7. Press the **CLR** key to return to radio operation.

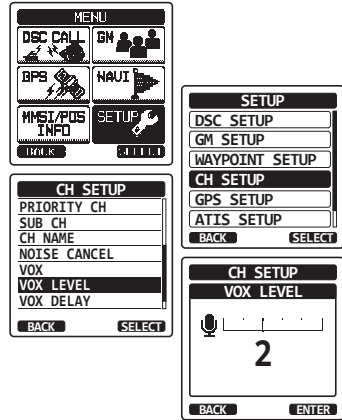

NOTE

During setup the VOX level can be seen directly by speaking into the microphone while the VOX operation is enabled.

14.11.3 Setting the VOX Delay Time

1. Press the **MENU** key to display "MENU".
2. Select "SETUP" with the **CH▼/CH▲/◀/▶** key, then press the **[SELECT]** soft key.
3. Select "CH SETUP" with the **CH▼/CH▲** key, then press the **[SELECT]** soft key.
4. Select "VOX DELAY" with the **CH▼/CH▲** key, then press the **[SELECT]** soft key.
5. Press the **CH▼/CH▲** key to select the desired delay time from "0.5sec", "1.0sec", "1.5sec", "2.0sec" or "3.0sec".
6. Press the **[ENTER]** soft key to store the new setting.
7. Press the **CLR** key to return to radio operation.

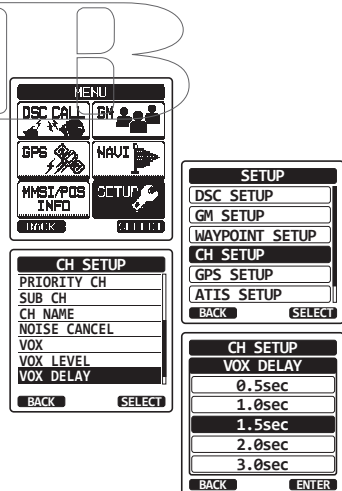

14.12 AUDIO FILTER OPERATION

This menu item allows you to select operation of the internal audio filter for your comfortable listening.

1. Press the **MENU** key to display “MENU”.
2. Select “SETUP” with the **CH▼/CH▲/◀/▶** key, then press the **[SELECT]** soft key.
3. Select “CH SETUP” with the **CH▼/CH▲** key, then press the **[SELECT]** soft key.
4. Select “AF PITCH” with the **CH▼/CH▲** key, then press the **[SELECT]** soft key.
5. Press the **CH▼/CH▲** key to select the desired filter operation.
6. Press the **[ENTER]** soft key to store the new setting.
7. Press the **CLR** key to return to radio operation.

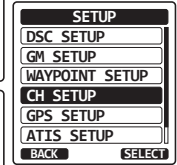
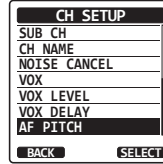

SVIB

14.13 SUMMARY OF THE CANNEL FUNCTION SETUP

Item	Description	Default Value
CH GROUP	Selects the channel group	USA: USA
WX ALERT	Turns on or off the Weather Alert function	Off
SCAN MEMORY	Add or remove a channel to Scan Memory	-
SCAN TYPE	Select priority scan or memory scan	PRIORITY
SCAN RESUME	Sets the resume time of scanning	2 sec
MULTI WATCH	Selects Dual Watch or Triple Watch	DUAL
PRIORITY CH	Selects a priority channel	CH16
SUB CH	Selects a Sub Channel	CH09
CH NAME	Edit the name of memory channels	-
NOISE CANCEL	Turns on or off of noise cancelling function (independently available for transmission and reception)	Off
VOX	Turn on or off the VOX function	Off
VOX LEVEL	Selects the VOX gain	2
VOX DELAY	Selects the VOX delay time	1.5 sec
AF PITCH	Selects the audio filter operation	Normal

SVMB

15 DSC SETUP

15.1 INDIVIDUAL DIRECTORY

The **HX870** has a DSC directory that allows you to store a vessel or person's name and the associated MMSI you wish to contact via individual calls, position requests and position report transmissions.

To transmit an individual call you must program this directory with information of the vessel you wish to contact, similar to a cellular phones telephone directory. Refer to section "**10.5.1 Setting up the Individual / Position Call Directory**" for details.

15.2 INDIVIDUAL REPLY

This menu item sets up the radio to automatically (default setting) or manually respond to a DSC Individual call requesting you to switch to a working channel for voice communications. When "MANUAL" is selected the MMSI of the calling vessel is shown allowing you to see who is calling. This function is similar to caller id on a cellular phone.

Refer to section "**10.5.2 Setting up the Individual Call Reply**" for details.

15.3 INDIVIDUAL ACKNOWLEDGMENT

The radio can be setup to transmit a reply automatically (default) or set so the radio will not reply to an individual call.

Refer to section "**10.5.3 Enabling the Individual Call Acknowledgment**" for details.

15.4 INDIVIDUAL RINGER

The radio can be setup to ring like a telephone to alert you the radio received a DSC individual call. The default setting is 2 minutes, however this can be changed to 5, 10 or 15 seconds with the procedure below.

Refer to section "**10.5.6 Setting up the Individual Call Ringer**" for details.

15.5 GROUP DIRECTORY

For this function to operate, the same group MMSI must be programmed into all the DSC VHF radios within the group of vessels that will be using this feature.

Refer to section "**10.6.1 Setting up a Group Call**" for details.

15.6 AUTO POS POLLING

The **HX870** has the capability to automatically track seven vessels programmed into the individual directory.

Refer to section “**10.10 AUTO POS POLLING**” for details.

15.7 AUTO POS INTERVAL

The **HX870** has the capability to automatically track seven vessels programmed into the individual directory.

Selecting the auto position polling time interval between position request transmissions to be setup.

Refer to section “**10.10.1 Setting up the Polling Time Interval**” for details.

15.8 CHANNEL SWITCH TIMER

When a DSC distress or an all ships (urgency or safety) call is received, the **HX870** will automatically switch to Channel 16.

This menu selection allows the automatic switch time to be changed. The default selection is 30 seconds.

1. Press the **MENU** key to display “MENU”.
2. Select “SETUP” with the **CH▼/CH▲/◀/▶** key, then press the **[SELECT]** soft key.
3. Select “DSC SETUP” with the **CH▼/CH▲** key, then press the **[SELECT]** soft key.
4. Select “CH SWITCH TIMER” with the **CH▼/CH▲** key, then press the **[SELECT]** soft key.
5. Press the **CH▼/CH▲** key to select the desired time, then press the **[ENTER]** soft key.
6. Press the **CLR** key to return to radio operation.

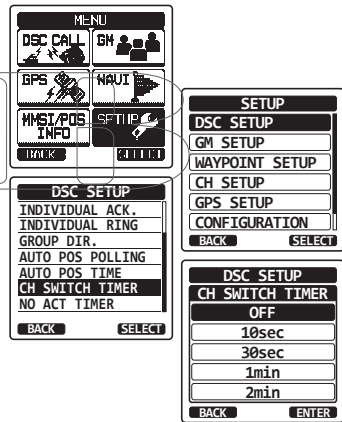

When the “OFF” is selected, “C” icon will light up on the screen.

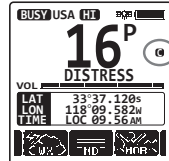

15.9 NO ACT (ACTION) TIMER

If no key is pressed during the “MENU” or “DSC CALL” screen, the HX870 will automatically return to radio operation.

The default selection is 15 minutes.

1. Press the **MENU** key to display “MENU”.
2. Select “SETUP” with the **CH▼/CH▲/◀/▶** key, then press the **[SELECT]** soft key.
3. Select “DSC SETUP” with the **CH▼/CH▲** key, then press the **[SELECT]** soft key.
4. Select “NO ACT TIMER” with the **CH▼/CH▲** key, then press the **[SELECT]** soft key.
5. Press the **CH▼/CH▲** key to select the desired time, then press the **[ENTER]** soft key.
6. Press the **CLR** key to return to radio operation.

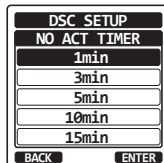
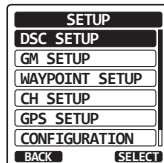
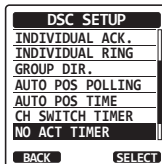
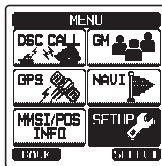

15.10 WAIT TIME FOR POSITION FIX

This menu allows you to select the maximum wait time till obtaining a position information when receiving a distress call, POS Report call, or acknowledgment to POS request call.

The default selection is 15 seconds.

1. Press the **MENU** key to display “MENU”.
2. Select “SETUP” with the **CH▼/CH▲/◀/▶** key, then press the **[SELECT]** soft key.
3. Select “DSC SETUP” with the **CH▼/CH▲** key, then press the **[SELECT]** soft key.
4. Select “POS FIX WAIT” with the **CH▼/CH▲** key, then press the **[SELECT]** soft key.
5. Press the **CH▼/CH▲** key to select the desired time, then press the **[ENTER]** soft key.
6. Press the **CLR** key to return to radio operation.

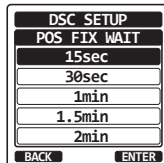
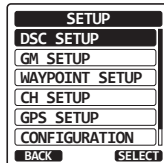
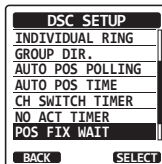
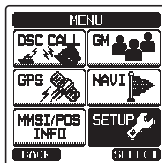

15.11 DSC BEEP

This feature allows the alarm beeps to be turned on or off when a DSC call is received. The DSC calls that can be customized are: individual, group, all ships, position request, and position report.

Refer to section “**10.6.4 Setting up the Group Call Ringer**” for details.

15.12 SUMMARY OF THE DSC SETUP MENU

Item	Description	Default Value
INDIVIDUAL DIR.	Enter or edit addresses used for individual call	-
INDIVIDUAL REPLY	Selects a reply to individual call	MANUAL
INDIVIDUAL ACK.	Selects the message to be sent automatically as an individual call acknowledgement	ENABLE
INDIVIDUAL RING	Selects the ringing time when an individual call or a position request is received	2 min
GROUP DIR.	Enter or edit addresses used for group call	-
AUTO POS POLLING	Selects the AUTO POS POLLING operation type	AUTO POS REQUEST
AUTO POS TIME	Selects the transmission interval of AUTO POS POLLING signal	30 sec
CH SWITCH TIMER	Selects the delay time to move to the requested channel automatically after receiving a distress call, All Ship call, or group call	30 sec
NO ACT (ACTION) TIMER	Selects the delay time to return to radio operation automatically after no key press	15 min
POS FIX WAIT	Sets the maximum wait time to obtain position information when receiving a distress call, POS Report call, or acknowledgement to POS request call	15 sec
DSC BEEP	Turns on or off the audible alarm when receiving a DSC call	Indivi.: On All Ship: On Group: On POS RQ.: Off POS RP.: On Geog.: On Polling: Off Test Call: Off

16 GPS SETUP

The “GPS Setup” mode allows the parameters for the **HX870** internal GPS unit to be customized for your operating requirements.

16.1 GPS ON/OFF

This selection allows the internal GPS unit to be turned on or off to conserve battery power. The default setting is “ON”.

1. Press the **MENU** key to display “MENU”.
2. Select “SETUP” with the **CH▼/CH▲/◀/▶** key, then press the **[SELECT]** soft key.
3. Select “GPS SETUP” with the **CH▼/CH▲** key, then press the **[SELECT]** soft key.
4. Select “GPS ON/OFF” with the **CH▼/CH▲** key, then press the **[SELECT]** soft key.
5. Press the **CH▼/CH▲** key to select “OFF”, “ON”, or “INT and PWR OFF”.
6. Press the **[ENTER]** soft key to save the new setting.
7. Press the **CLR** key to return to radio operation.

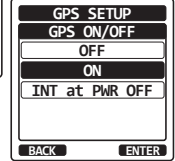
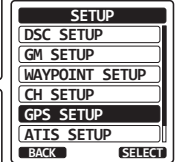
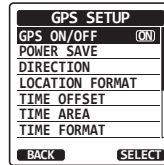

16.2 POWER SAVE

This menu item selects the Battery Save Mode for the internal GPS unit. The default setting for the Power Save Mode is “AUTO”.

1. Press the **MENU** key to display “MENU”.
2. Select “SETUP” with the **CH▼/CH▲/◀/▶** key, then press the **[SELECT]** soft key.
3. Select “GPS SETUP” with the **CH▼/CH▲** key, then press the **[SELECT]** soft key.
4. Select “POWER SAVE” with the **CH▼/CH▲** key, then press the **[SELECT]** soft key.

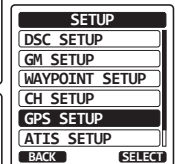
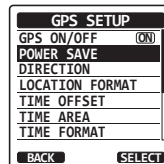
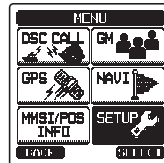

- Press the **CH▼/CH▲** key to select the desired level.

OFF: GPS Signals are always being received.

AUTO: Activates the GPS receiver automatically when GPS signals are received.

50%: Activates the GPS receiver for 3 seconds every 3 seconds.

75%: Activates the GPS receiver for 3 seconds every 9 seconds.

90%: Activates the GPS receiver for 3 seconds every 27 seconds.

- Press the **[ENTER]** soft key to store the selected setting.
- Press the **CLR** key to return to radio operation.

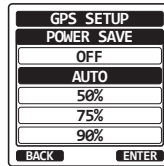

16.3 DISPLAY DIRECTION

This menu item selects the compass direction to be shown on the **HX870** display. The default setting is “course up”.

- Press the **MENU** key to display “MENU”.
- Select “SETUP” with the **CH▼/CH▲/◀/▶** key, then press the **[SELECT]** soft key.
- Select “GPS SETUP” with the **CH▼/CH▲** key, then press the **[SELECT]** soft key.
- Select “DIRECTION” with the **CH▼/CH▲** key, then press the **[SELECT]** soft key.
- Press the **CH▼/CH▲** key to select the desired direction from “COURSE UP” and “NORTH UP”.
- Press the **[ENTER]** soft key to save the new setting.
- Press the **CLR** key to return to radio operation.

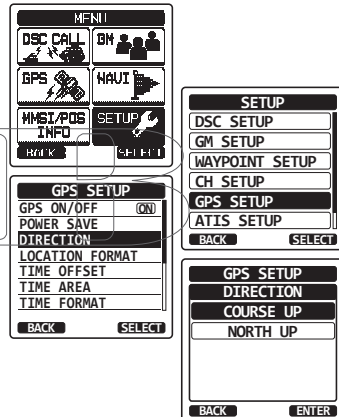

16.4 LOCATION FORMAT

This menu item selects the coordinate system to be shown on the **HX870** display. The default setting is “ddd mm.mmm”.

1. Press the **MENU** key to display “MENU”.
2. Select “SETUP” with the **CH▼/CH▲/◀/▶** key, then press the **[SELECT]** soft key.
3. Select “GPS SETUP” with the **CH▼/CH▲** key, then press the **[SELECT]** soft key.
4. Select “LOCATION FORMAT” with the **CH▼/CH▲** key, then press the **[SELECT]** soft key.
5. Press the **CH▼/CH▲** key to select the desired coordinate system. The location format can be selected from “ddd°mm.mmm”, “ddd°mm.mm”, and “ddd°mm’ss”.
6. Press the **[ENTER]** soft key to save the new setting.
7. Press the **CLR** key to return to radio operation.

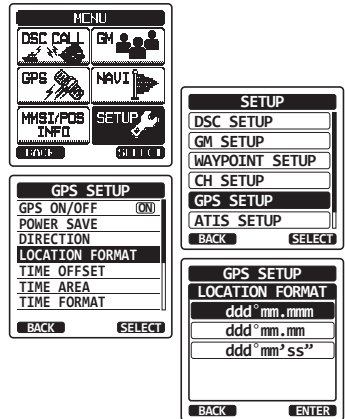

16.5 TIME OFFSET

Sets the local time offset between UTC (Universal Time Coordinated) and local time shown on the display. The offset is added or subtracted from the time received from the GPS.

Refer to section “**6.4 CHANGING THE GPS TIME**” for details.

16.6 TIME AREA

This menu selection allows the radio to show UTC time or local time with the offset.

Refer to section “**6.5 CHANGING THE TIME LOCATION**” for details.

16.7 TIME FORMAT

This menu selection allows the radio to show time in 12-hour or 24-hour format.

Refer to section “**6.6 CHANGING THE TIME FORMAT**” for details.

16.8 UNITS OF MEASURE

This section allows you to set the speed, distance and altitude units.

1. Press the **MENU** key to display “MENU”.
2. Select “SETUP” with the **CH▼/CH▲/◀/▶** key, then press the **[SELECT]** soft key.
3. Select “GPS SETUP” with the **CH▼/CH▲** key, then press the **[SELECT]** soft key.
4. Select “UNITS OF MEASURE” with the **CH▼/CH▲** key, then press the **[SELECT]** soft key.
5. Press the **CH▼/CH▲** key to select the item you want to set.
6. Press the **[SELECT]** soft key.
7. Press the **CH▼/CH▲** key to select the unit.
8. Press the **[ENTER]** soft key to store the new setting.
9. Press the **CLR** key to return to radio operation.

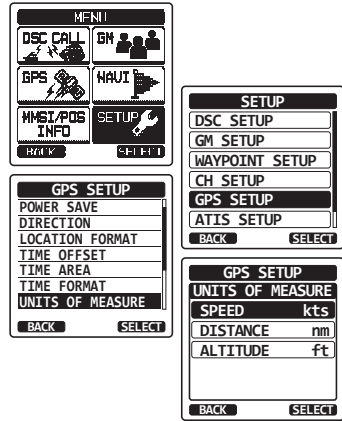

16.9 PINNING

This selection is used to enable or disable position updates when the vessel is not underway. The default setting is “OFF”.

1. Press the **MENU** key to display “MENU”.
2. Select “SETUP” with the **CH▼/CH▲/◀/▶** key, then press the **[SELECT]** soft key.
3. Select “GPS SETUP” with the **CH▼/CH▲** key, then press the **[SELECT]** soft key.
4. Select “PINNING” with the **CH▼/CH▲** key, then press the **[SELECT]** soft key.
5. Press the **CH▼/CH▲** key to select “ON” or “OFF”.

ON: When pinning is turned on, the **HX870** will not update its position unless the vessel travels over 10Ft.

OFF: When the vessel is underway or stopped, the **HX870** continuously updates its position. This improves accuracy of the position fix.

6. Press the **[ENTER]** soft key to save the new setting.
7. Press the **CLR** key to return to radio operation.

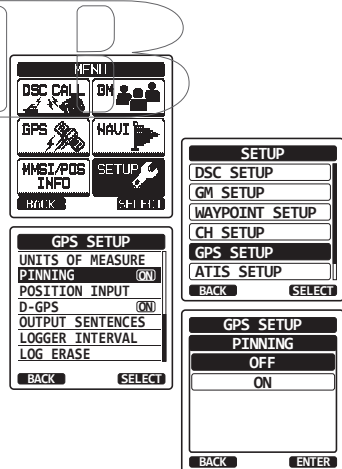

16.10 SBAS (Satellite Based Augmentation System)

This selection enables or disables SBAS such as WAAS, EGNOS and MSAS as some areas (Australia for example) can have problems with GPS reception with SBAS enabled. The default setting is “ON”.

1. Press the **MENU** key to display “MENU”.
2. Select “SETUP” with the **CH▼/CH▲/◀/▶** key, then press the **[SELECT]** soft key.
3. Select “GPS SETUP” with the **CH▼/CH▲** key, then press the **[SELECT]** soft key.
4. Select “D-GPS” with the **CH▼/CH▲** key, then press the **[SELECT]** soft key.
5. Press the **CH▼/CH▲** key to select “ON” or “OFF”.
6. Press the **[ENTER]** soft key to store the new setting.
7. Press the **CLR** key to return to radio operation.

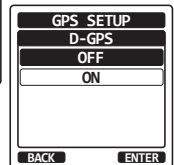
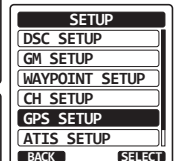
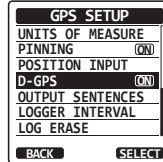
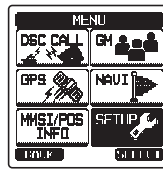

16.11 OUTPUT SENTENCES

This selection is used to setup the NMEA output sentences of the HX870. By default, all the NMEA sentences are turned “OFF”.

1. Press the **MENU** key to display “MENU”.
2. Select “SETUP” with the **CH▼/CH▲/◀/▶** key, then press the **[SELECT]** soft key.
3. Select “GPS SETUP” with the **CH▼/CH▲** key, then press the **[SELECT]** soft key.
4. Select “OUTPUT SENTENCES” with the **CH▼/CH▲** key, then press the **[SELECT]** soft key.
5. Press the **CH▼/CH▲** key to select the desired sentence type, then press the **[SELECT]** soft key.
6. Press the **CH▼/CH▲** key to select “ON” or “OFF”.
7. Press the **[ENTER]** soft key to save the new setting.
8. Repeat steps 5 through 7 to set the other sentences.
9. Press the **CLR** key to return to radio operation.

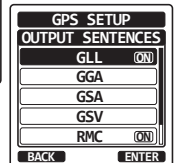
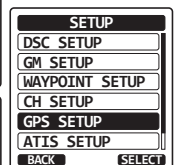
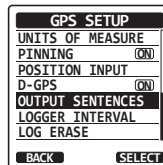
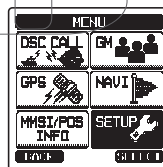

16.12 LOGGER INTERVAL

1. Press the **MENU** key to display "MENU".
2. Select "SETUP" with the **CH▼/CH▲/◀/▶** key, then press the **[SELECT]** soft key.
3. Select "GPS SETUP" with the **CH▼/CH▲** key, then press the **[SELECT]** soft key.
4. Select "LOGGER INTERVAL" with the **CH▼/CH▲** key, then press the **[SELECT]** soft key.
5. Press the **CH▼/CH▲** key to select the desired time and press the **[ENTER]** soft key.

Note: Log time for each logger interval setting

- 5 sec: Aprox. 8 hours
- 15 sec: Aprox. 25 hours
- 30 sec: Aprox. 50 hours
- 1 min: Aprox. 100 hours
- 5 min: Aprox. 500 hours

6. Press the **CLR** key to return to radio operation.

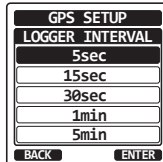
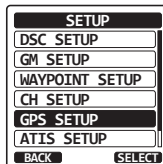
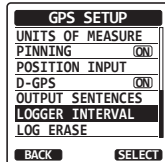
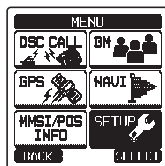

16.13 LOG ERASE

1. Press the **MENU** key to display "MENU".
2. Select "SETUP" with the **CH▼/CH▲/◀/▶** key, then press the **[SELECT]** soft key.
3. Select "GPS SETUP" with the **CH▼/CH▲** key, then press the **[SELECT]** soft key.
4. Select "LOG ERASE" with the **CH▼/CH▲** key, then press the **[SELECT]** soft key.
5. Press the **CH▼/CH▲** key to select "CANCEL" or "OK", then press the **[ENTER]** soft key.
6. Press the **CLR** key to return to radio operation.

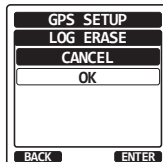
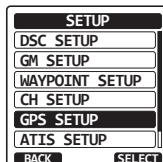
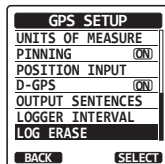
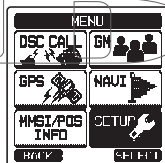

16.14 SUMMARY OF THE GPS SETUP

Item	Description	Default Value
GPS ON/OFF	Turns on or off the GPS receiver	ON
POWER SAVE	Selects the power save mode of the GPS unit	AUTO
DIRECTION	Selects the compass direction to be displayed	COURSE UP
LOCATION FORMAT	Selects the coordinate system to be displayed	ddd°mm.mmm
TIME OFFSET	Sets the offset time from the UTC (available only when "LOCAL" is selected in the item "TIME AREA")	00:00
TIME AREA	Selects the time location to be displayed, from UTC or local	UTC
TIME FORMAT	Selects the time format to be displayed, 12-hour or 24-hour (fixed to "24H" when "UTC" is selected in the item "TIME AREA")	24H
UNITS OF MEASURE	Selects the unit of measure when displaying speed, distance, and altitude	SPEED: kts DISTANCE: nm ALTITUDE: ft
PINNING	Turns on or off GPS position updates for vessel not underway	OFF
D-GPS	Turns on or off of use of SBAS	ON
OUTPUT SENTENCES	Selects a sentence to be output to the USB terminal	OFF
LOGGER INTERVAL	Selects the interval time of logging	1 min
LOG ERASE	Erases the log data	-

17 MAINTENANCE

The inherent quality of the solid-state components used in this transceiver will provide many years of continuous use. Taking the following precautions will prevent damage to the transceiver.

- Never key the microphone unless an antenna or suitable dummy load is connected to the transceiver.
- Use only STANDARD HORIZON approved accessories and replacement parts.

In the unlikely event of serious problems, please contact your Dealer or our repair facility. Address and phone numbers for this facility, as well as warranty information, are contained in section “19 WARRANTY”.

17.1 REPLACEMENT PARTS

Occasionally an owner needs a replacement mounting bracket or knob. These can be ordered from our Parts Department by emailing yaesuparts@yaesu.com or calling:

Marine Division of YAESU U.S.A.

6125 Phyllis Drive, Cypress, California 90630

Telephone (714) 827-7600

Commonly requested parts, and their part numbers are listed below.

- **SBH-12** Charger Cradle: CB6458001
- **CAT460** Antenna: AY139X001
- **Belt Clip** (CLIP-22): CP9672002
- **MIC/SP** Plastic Cap: RA108700B
- **MIC/SP** Cap O-Ring: RA046760A
- **MIC/SP** Rubber: RA1555900

17.2 FACTORY SERVICE

In the unlikely event that the radio fails to perform or needs servicing, please contact the following:

Standard Horizon

Attention Marine Repair Department

6125 Phyllis Drive, Cypress, California 90630, U.S.A.

Telephone (800) 366-4566

For repairs in Canada

Westcom Marine

488 East 62nd Avenue Vancouver BC V5X2G1

Telephone (604) 327-6280

An "RA" (Return Authorization) number is not necessary to send a product in for service. Include a brief note describing the problem along with your name, return address, phone number, and proof of purchase.

17.3 TROUBLESHOOTING CHART

SYMPTOM	PROBABLE CAUSE	REMEDY
The USA/INTL/CAN modes do not function.	Proper operation not followed.	Specify the item number from "SETUP MENU" – "CH SETUP" – "CH GROUP".
Cannot output sound by pressing and holding the SQL key.	Low battery.	Charge battery. Refer to section 6 of this manual.
	Audio volume level is too low.	Press the VOL+ key until background noise outputs.
Cannot transmit a DSC Call.	MMSI number is not programmed.	Program the MMSI number. Refer to section "10.2.2 Programming the MMSI".
Cannot fix the GPS satellites.	Internal GPS receiver is "off".	Internal GPS receiver is "on". Refer to "15.1 GPS ON/OFF".
	Poor location for GPS satellite reception.	Move to a less obstructed position.
Charge indicator does not appear on the display when charging a battery.	Defective battery SBR-13LI .	Contact Standard Horizon dealer.
	The transceiver is not set onto the SBH-12 Charger Cradle properly.	Set the transceiver onto the SBH-12 Charger Cradle properly.
	Power is not supplied to the SBH-12 Charger Cradle.	Connect SAD-11B or E-DC-19A to the SBH-12 Charger Cradle for AC/DC power supplies.

18 CHANNEL ASSIGNMENTS

Tables on the following columns list the VHF Marine Channel assignments for U.S.A. and International use. Below are listed some data about the charts.

1. VTS. Where indicated, these channels are part of the U.S. Coast Guard's Vessel Traffic System.
2. Alpha channel numbers, that is, channel numbers followed by the letter A (such as Channel 07A) are **simplex** channels on the U.S.A. or Canadian channel assignments whose counterparts in the International assignments are **duplex** channels. International channels do not use "alpha" numbers. If you call the Coast Guard on Channel 16, they will sometimes ask you to "**go to channel 22 Alpha**". This is a channel assigned to U.S.A. and Canadian Coast Guards for handling distress and other calls. If your radio is set for **International** operation you will go to Channel 22 instead of 22A, and will not be able to communicate with the Coast Guard. To use Channel 22A, your radio must be set for **USA** or **Canada** operation, usually by a U/I/C (USA/International/Canada) control or combination of controls. Channel 22 (without an "A") is an **International** duplex channel for port operations. Some radios indicate an "A" adjacent to the alpha channels on the display; on others "alpha" is not indicated but the proper channel is selected based on the U/I/C setting.
3. Bridge-to-Bridge channels (for example, Channel 13) are for use by bridge operators on inter-coastal waterways and rivers. It is also used by marine vessels in the vicinity of these bridges for navigation and for communicating with the bridge operators. Note that a limit of 1 Watt is specified for these channels.
4. The **S/D** column on the chart indicates either S (simplex) or D (duplex). **Simplex** means transmitting and receiving on the same frequency. Only one party at a time can talk, unlike a telephone. Be sure to say "**over**" and release your microphone push-to-talk switch at the end of each transmission. **Duplex** operation involves the use of one frequency for transmitting and a separate frequency for receiving. On channels specified as duplex on the charts, correct mode of operation is established automatically by your radio when you select a channel; you cannot change the mode. And you still must release the push-to-talk switch after each transmission in order to listen to the radio.
5. Channels normally used by recreational boaters are those that include the term "non-commercial" in the **Channel Use** column of the chart. Some of these are shared with other users and some are used only in certain geographic regions.

6. Marine vessels equipped with VHF radios are required to monitor Channel 16.
7. 156.050 MHz and 156.175 MHz are available for port operations and commercial communications purposes when used only within the U.S. Coast Guard designated Vessel Traffic Services (VTS) area of New Orleans, on the lower Mississippi River from the various pass entrances in the Gulf of Mexico to Devil's Swamp Light at River Mile 242.4 above head of passes near Baton Rouge.
8. 156.250 MHz is available for port operations communications use only within the U.S. Coast Guard designated VTS radio protection areas of New Orleans and Houston described in Sec. 80.383. 156.250 MHz is available for intership port operations communications used only within the area of Los Angeles and Long Beach harbors, within a 25- nautical mile radius of Point Fermin, California.
9. 156.550 MHz, 156.600 MHz and 156.700 MHz are available in the U.S. Coast Guard designated port areas only for VTS communications and in the Great Lakes available primarily for communications relating to the movement of ships in sectors designated by the St. Lawrence Seaway Development Corporation or the U.S. Coast Guard. The use of these frequencies outside VTS and ship movement sector protected areas is permitted provided they cause no interference to VTS and ship movement communications in their respective designated sectors.
10. Use of 156.875 MHz is limited to communications with pilots regarding the movement and docking of ships. Normal output power must not exceed 1 watt. 5: 156.375 MHz and 156.650 MHz are available primarily for intership navigational communications. These frequencies are available between coast and ship on a secondary basis when used on or in the vicinity of locks or drawbridges. Normal output power must not exceed 1 watt. Maximum output power must not exceed 10 watts for coast stations or 25 watts for ship stations.
11. On the Great Lakes, in addition to bridge-to-bridge communications, 156.650 MHz is available for vessel control purposes in established vessel traffic systems. 156.650 MHz is not available for use in the Mississippi River from South Pass Lighted Whistle Buoy "2" and Southwest Pass entrance Mid-channel Lighted Whistle Buoy to mile 242.4 above Head of Passes near Baton Rouge. Additionally it is not available for use in the Mississippi River-Gulf Outlet, the Mississippi River-Gulf Outlet Canal, and the Inner Harbor Navigational Canal, except to aid the transition from these areas.
12. Use of 156.375 MHz is available for navigational communications only in the Mississippi River from South Pass Lighted Whistle Buoy "2" and South-

west Pass entrance Mid channel Lighted Whistle Buoy to mile 242.4 above head of Passes near Baton Rouge, and in addition over the full length of the Mississippi River-Gulf Outlet Canal from entrance to its junction with the Inner Harbor Navigation Canal, and over the full length of the Inner Harbor Navigation Canal from its junction with the Mississippi River to its entry to Lake Pontchartrain at the New Seabrook vehicular bridge.

13. Within 120 km (75 miles) of the United States/Canada border, in the area of the Puget Sound and the Strait of Juan de Fuca and its approaches, 157.425 MHz is half of the duplex pair designated as Channel 88. In this area, Channel 88 is available to ship stations for communications with public coast stations only. More than 120 km (75 miles) from the United States/Canada border in the area of the Puget Sound and the Strait of Juan de Fuca, its approaches, the Great Lakes, and the St. Lawrence Seaway, 157.425 MHz is available for intership and commercial communications. Outside Puget Sound area and its approaches and the Great Lakes, 157.425 MHz is also available for communications between commercial fishing vessels and associated aircraft while engaged in commercial fishing activities.
14. When the frequency 156.850 MHz is authorized, it may be used additionally for search and rescue training exercises conducted by state or local governments.
15. The frequency 156.850 MHz is additionally available to coast stations on the Great Lakes for transmission of scheduled Coded Marine Weather Forecasts (MAFOR), Great Lakes Weather Broadcast (LAWEB) and scheduled Notices to Mariners or Bulletins. F3C and J3C emissions are permitted. Coast Stations on the Great Lakes must cease weather broadcasts which cause interference to stations operating on 156.800 MHz until the interference problem is resolved.
16. The frequency 157.100 MHz is authorized for search and rescue training exercises by state or local government in conjunction with U.S. Coast Guard stations. Prior U.S. Coast Guard approval is required. Use must cease immediately on U.S. Coast Guard request.
17. The duplex pair for channel 20 (157.000/161.600 MHz) may be used for ship to coast station communications.
18. Available for assignment to coast stations, the use of which is in accord with an agreed program, for the broadcast of information to ship stations concerning the environment.

VHF MARINE CHANNEL CHART							
CH	U	C	I	S/D	TX RX		CHANNEL USE
01		X	X	D	156.050	160.650	Public Correspondence (Marine Operator)
01A	X			S	156.050		Port Operation and Commercial. VTS in selected areas
02		X	X	D	156.100	160.700	Public Correspondence (Marine Operator)
03		X	X	D	156.150	160.750	Public Correspondence (Marine Operator)
03A	X			S	156.150		U.S. Government Only, Coast Guard
04			X	D	156.200	160.800	Public Correspondence (Marine Operator), Port operation, ship movement
04A		X		S	156.200		Pacific coast: Coast Guard, East Coast: Commercial fishing
05			X	D	156.250	160.850	Public Correspondence (Marine Operator), Port operation, ship movement
05A	X	X		S	156.250		Port operation. VTS in Seattle
06	X	X	X	S	156.300		Inter-ship Safety
07			X	D	156.350	160.950	Public Correspondence (Marine Operator), Port operation, ship movement
07A	X	X		S	156.350		Commercial
08	X	X	X	S	156.400		Commercial (Inter-ship only)
09	X	X	X	S	156.450		Boater Calling channel, Commercial & Non-commercial (Recreational)
10	X	X	X	S	156.500		Commercial
11	X	X	X	S	156.550		Commercial. VTS in selected areas
12	X	X	X	S	156.600		Port operation. VTS in selected areas
13	X	X	X	S	156.650		Inter-ship Navigation Safety (Bridge-to-bridge)
14	X	X	X	S	156.700		Port operation. VTS in selected areas
15	X			S	--	156.750	Environmental (Receive only)
15		X	X	S	156.750		Commercial, non-commercial, ship movement (1 W)
16	X	X	X	S	156.800		International Distress, Safety and Calling
17	X	X	X	S	156.850		State Controlled (1 W)
18			X	D	156.900	161.500	Port operation, ship movement
18A	X	X		S	156.900		Commercial
19			X	D	156.950	161.550	Port operation, ship movement
19A	X			S	156.950		US: Commercial
19A		X		S	156.950		Coast Guard
20	X	X	X	D	157.000	161.600	Canadian Coast Guard Only, International: port operations and shipment
20A	X			S	157.000		Port operation
21			X	D	157.050	161.650	Port operation, ship movement
21A	X	X		S	157.050		U.S. Government Only, Canadian Coast Guard
22			X	D	157.100	161.700	Port operation, ship movement
22A	X	X		S	157.100		US and Canadian Coast Guard Liaison and ar- timate Safety Information Broadcasts announced on channel 16
23		X	X	D	157.150	161.750	Public Correspondence (Marine Operator)
23A	X			S	157.150		U.S. Government Only
24	X	X	X	D	157.200	161.800	Public Correspondence (Marine Operator)
25	X	X	X	D	157.250	161.850	Public Correspondence (Marine Operator)
26	X	X	X	D	157.300	161.900	Public Correspondence (Marine Operator)
27	X	X	X	D	157.350	161.950	Public Correspondence (Marine Operator)
28	X	X	X	D	157.400	162.000	Public Correspondence (Marine Operator)

VHF MARINE CHANNEL CHART

CH	U	C	I	S/D	TX	RX	CHANNEL USE
60		X	X	D	156.025	160.625	Public Correspondence (Marine Operator)
61			X	D	156.075	160.675	Public Correspondence (Marine Operator), Port operation, ship movement
61A	X	X		S	156.075		Public Coast: Coast Guard; East Coast: commercial fishing only
62			X	D	156.125	160.725	Public Correspondence (Marine Operator), Port operation, ship movement
62A		X		S	156.125		Public Coast: Coast Guard; East Coast: commercial fishing onl
63			X	D	156.175	160.775	Public Correspondence (Marine Operator), Port operation, ship movement
63A	X	X		S	156.175		Port Operation and Commercial. VTS in selected areas
64		X	X	D	156.225	160.825	Public Correspondence (Marine Operator), Port operation, ship movement
64A	X	X		S	156.225		Public Correspondence (Marine Operator), Port operation, ship movement
65			X	D	156.275	160.875	Public Correspondence (Marine Operator), Port operation, ship movement
65A	X	X		S	156.275		Port Operations
66			X	D	156.325	160.925	Public Correspondence (Marine Operator), Port operation, ship movement
66A	X	X		S	156.325		Port Operations
67	X	X	X	S	156.375		US: Commercial. Used for Bridge-to-bridge communi-cations in lower Mississippi River. Inter-ship only, Canada: Commercial fishing, S&R
68	X	X	X	S	156.425		Non-commercial (Recreational)
69	X	X	X	S	156.475		US: Non-commercial (Recreational), Canada: Commercial fishing only, International: Inter-ship, Port operations and Ship movement
70	X	X	X	S	156.525		Digital selective calling (voice communications not allowed)
71	X	X	X	S	156.575		US, Canada: Non-commercial (Recreational), International: Port operations and Ship move- ment
72	X	X	X	S	156.625		Non-commercial (Inter-ship only)
73	X	X	X	S	156.675		US: Port Operations, Canada: Commercial fishing only, International: Inter-ship, Port operations and Ship movement
74	X	X	X	S	156.725		US: Port Operations, Canada: Commercial fishing only, International: Inter-ship, Port operations and Ship movement
75	X	X	X	S	156.775		Port Operations (Inter-ship only) (1W)
76	X	X	X	S	156.825		Port Operations (Inter-ship only) (1W)
77	X	X		S	156.875		Port Operations (Inter-ship only) (1W)
77			X	S	156.875		Port Operations (Inter-ship only)
78			X	D	156.925	161.525	Public Correspondence (Marine Operator), Port operation, ship-movement
78A	X	X		S	156.925		Non-commercial (Recreational)
79			X	D	156.975	161.575	Port operation and Ship movement
79A	X	X		S	156.975		Commercial

VHF MARINE CHANNEL CHART							
CH	U	C	I	S/D	TX	RX	CHANNEL USE
80			X	D	157.025	161.625	Port operation, ship movement
80A	X	X		S	157.025		Commercial
81			X	D	157.075	161.675	Port operation, ship movement
81A	X			S	157.075		U.S. Government Only - Environmental protection operations
81A		X		S	157.075		Canadian Coast Guard Only
82			X	D	157.125	161.725	Public Correspondence (Marine Operator), Port operation, ship movement
82A	X	X		S	157.125		U.S. Government Only, Canadian Coast Guard Only
83		X		D	157.175	161.775	Canadian Coast Guard Only
83			X	D	157.175	161.775	Public Correspondence (Marine Operator)
83A	X	X		S	157.175		U.S. Government Only, Canadian Coast Guard Only
84	X	X	X	D	157.225	161.825	Public Correspondence (Marine Operator)
85	X	X	X	D	157.275	161.875	Public Correspondence (Marine Operator)
86	X	X	X	D	157.325	161.925	Public Correspondence (Marine Operator)
87		X	X	S	157.375		Port operation, ship movement
87A	X			S	157.375		Public Correspondence (Marine Operator)
88		X	X	S	157.425		Port operation, ship movement
88A	X			S	157.425		Commercial, Inter-ship Only
WX01	X	X	X	D	---	162.550	Weather (receive only)
WX02	X	X	X	D	---	162.400	Weather (receive only)
WX03	X	X	X	D	---	162.475	Weather (receive only)
WX04	X	X	X	D	---	162.425	Weather (receive only)
WX05	X	X	X	D	---	162.450	Weather (receive only)
WX06	X	X	X	D	---	162.500	Weather (receive only)
WX07	X	X	X	D	---	162.525	Weather (receive only)
WX08	X	X	X	D	---	161.650	Weather (receive only)
WX09	X	X	X	D	---	161.775	Weather (receive only)
WX10	X	X	X	D	---	163.275	Weather (receive only)

NOTE: Simplex channels, 03A, 21A, 23A, 61A, 64A, 81A, 82A and 83A CANNOT be lawfully used by the general public in U.S.A. waters.

19 WARRANTY

Marine Products Limited Warranty

PLEASE NOTE

The following "Limited Warranty" is valid for products that have been purchased in the United States and Canada. For limited Warranty details outside the United States, contact the dealer in your country.

STANDARD HORIZON (a division of YAESU U.S.A.) warrants, to the original purchaser only, each new Marine Communications Product ("Product") manufactured and/or supplied by STANDARD HORIZON against defects in materials and workmanship under normal use and service for a period of time from the date of purchase as follows:

Fixed Mount and Portable Transceivers

1 year - if purchased before 01/01/91

3 years - if purchased between 01/01/91 and 01/01/94

3 years Waterproof - if purchased after 01/01/94

Loud hailers

1 year - if purchased before 01/01/91

3 years - if purchased after 01/01/91

Associated Chargers

1 year - if purchased before 01/01/91

3 years - if purchased after 01/01/91

Associated Batteries - 1 year. Note: Batteries will be deemed defective only if storage capacity drops below 80% of rated capacity or if leakage develops.

Associated Accessories - 1 year. Includes: Microphones/Handsets, External Speakers, Antennas, Carrying Accessories, Power Supplies, and Signaling Boards.

To receive warranty service, the purchaser must deliver the Product, transportation and insurance prepaid, to STANDARD HORIZON, Attention Marine repairs 6125 Phyllis Drive, Cypress, California 90630, U.S.A. Include proof of purchase indicating model, serial number, and date of purchase. STANDARD HORIZON will return the Product to the purchaser freight prepaid. Products purchased prior to January 1, 1991 will bear the STANDARD HORIZON warranty terms in effect prior to that date.

In the event of a defect, malfunction or failure of the Product during the warranty period, STANDARD HORIZON's liability for any breach of contract or any breach of express or implied warranties in connection with the sale of Products shall be limited solely to repair or replacement, at its option, of the Product or

part(s) therein which, upon examination by STANDARD HORIZON, appear to be defective or not up to factory specifications. STANDARD HORIZON may, at its option, repair or replace parts or subassemblies with new or reconditioned parts and subassemblies. Parts thus repaired or replaced are warranted for the balance of the original applicable warranty.

STANDARD HORIZON will not warrant installation, maintenance or service of the Products. In all instances, STANDARD HORIZON's liability for damages shall not exceed the purchase price of the defective Product.

This warranty only extends to Products sold within the 50 States of the United States of America and the District of Columbia.

STANDARD HORIZON will pay all labor to repair the product and replacement parts charges incurred in providing the warranty service except where purchaser abuse or other qualifying exceptions exist. The purchaser must pay any transportation expenses incurred in returning the Product to STANDARD HORIZON for service.

This limited warranty does not extend to any Product which has been subjected to misuse, neglect, accident, incorrect wiring by anyone other than STANDARD HORIZON, improper installation, or subjected to use in violation of instructions furnished by STANDARD HORIZON, nor does this warranty extend to Products on which the serial number has been removed, defaced, or changed. STANDARD HORIZON cannot be responsible in any way for ancillary equipment not furnished by STANDARD HORIZON which is attached to or used in connection with STANDARD HORIZON's Products, or for the operation of the Product with any ancillary equipment, and all such equipment is expressly excluded from this warranty. STANDARD HORIZON disclaims liability for range, coverage, or operation of the Product and ancillary equipment as a whole under this warranty. STANDARD HORIZON reserves the right to make changes or improvements in Products, during subsequent production, without incurring the obligation to install such changes or improvements on previously manufactured Products.

The implied warranties which the law imposes on the sale of this Product are expressly LIMITED, in duration, to the time period specified above. STANDARD HORIZON shall not be liable under any circumstances for consequential damages resulting from the use and operation of this Product, or from the breach of this LIMITED WARRANTY, any implied warranties, or any contract with STANDARD HORIZON. IN CONNECTION WITH THE SALE OF ITS PRODUCTS, STANDARD HORIZON MAKES NO WARRANTIES, EXPRESS OR IMPLIED AS TO THE MERCHANTABILITY OR FITNESS FOR A PARTICULAR PURPOSE OR OTHERWISE, EXCEPT AS EXPRESSLY SET FORTH HEREIN.

Some states do not allow the exclusion or limitation of incidental or consequential damages, or limitation on how long an implied warranty lasts, so the above limitations or exclusions may not apply. This warranty gives specific legal rights, and there may be other rights which may vary from state to state.

ONLY PRODUCTS SOLD ON OR AFTER JANUARY 1, 1991 ARE COVERED UNDER THE TERMS OF THIS LIMITED WARRANTY.

ON-LINE WARRANTY REGISTRATION

THANK YOU for buying STANDARD HORIZON (a division of YAESU U.S.A.) products! We are confident your new radio will serve your needs for many years!

Please visit **www.standardhorizon.com** to register your Marine VHF. It should be noted that visiting the website from time to time may be beneficial to you, as new products are released they will appear on the STANDARD HORIZON website. Also a statement regarding product support should be added to the manual.

Product Support Inquiries

If you have any questions or comments regarding the use of the radio, you can visit the STANDARD HORIZON website to send an E-Mail or contact the Product Support team at (714) 827-7600 ext 6300 M-F 8:00-5:00 PST.

In addition to the warranty, STANDARD HORIZON includes a lifetime "flat rate" and "customer loyalty" programs to provide service after the warranty period has expired. If you wish to obtain the flat rate price for out-of-warranty repair, you must include the information on the Owner's Record with the unit when you return it to your Dealer or to STANDARD HORIZON.

Lifetime Flat Rate Service Program: For the original Owner only, for the lifetime of the unit, STANDARD HORIZON will repair the unit to original specifications.

Note: The flat rate amount is payable by the Owner only if STANDARD HORIZON or the STANDARD HORIZON Dealer determines that a repair is needed. After the repair, a 90-day warranty will be in effect from the date of return of the unit to the Owner.

This service program is not available for equipment which has failed as a result of neglect, accident, breakage, misuse, improper installation or modification, or water damage (depending on the product).

20 CONNECTING A USB DATA TERMINAL TO THE PC

The **HX870** outputs the following NMEA 0183 sentences 9600: GLL, GGA, GSA, GSV, RMC, DSC and DSE.

If you have further inquiries, please feel free to contact Product Support at:

Phone: (800) 767-2450

Email: marinetech@yaesu.com

You can also download the log data from the radio by using the PC Programming Software which may be downloaded from the Standard Horizon website. The PC Programming Software is compatible with Windows® Vista®, Windows 7, and Windows 8.

To connect a PC, use the supplied USB cable through the **DATA** jack of the **HX870**.

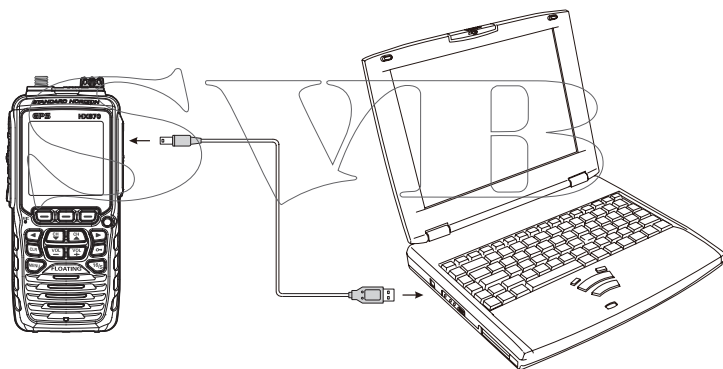

CAUTION

The **DATA** jack is NOT designed to be waterproof when the cover is opened. Connect the radio and PC in a dry location.

21 SPECIFICATIONS

Performance specifications are nominal, unless otherwise indicated, and are subject to change without notice. Measured in accordance with TIA/EIA-603.

21.1 GENERAL

Frequency Range	TX: 156.025 MHz - 157.425 MHz RX: 156.050 MHz - 163.275 MHz
Channel Spacing	25 kHz
Frequency Stability	±3 ppm (-4 °F to +140 °F [-20 °C to +60 °C])
Emission Type	16K0G3E for Voice, 16K0G2B for DSC
Antenna Impedance	50 Ω
Supply Voltage.....	7.4V DC, Negative Ground (Battery Terminal)
Current Consumption	330 mA (Receive) 100 mA (Standby, GPS On) 60 mA (Standby, GPS Off) 1.6 A / 1.0 A / 0.7 A (TX: 6W / 2W / 1W)
Operating Temperature.....	-4 °F to +140 °F (-20 °C to +60 °C)
DSC Individual Directory	Store up to 100
DSC Group Directory.....	Store up to 20
DSC Format.....	ITU-R M.493-13
NMEA Output.....	DSC, DSE, GLL, GGA, GSA, GSV, and RMC
Case Size (W x H x D).....	2.44" x 5.43" x 1.69" (62 mm x 138 mm x 43 mm) (w/o knob & antenna)
Weight	11.36 oz (322 g) w/ SBR-13LI, hand strap, belt clip & antenna

21.2 TRANSMITTER

RF Power Output.....	6 W (HI) / 2 W (MEDIUM) / 1 W (LOW) (@7.4 V)
Modulation Type	Variable Reactance
Maximum Deviation	±5 kHz
Spurious Emission.....	-75 dBc typical
Microphone Impedance	2 kΩ

21.3 RECEIVER (for Voice and DSC)

Circuit Type.....Double-Conversion Superheterodyne
Intermediate Frequencies.....for Voice 1st: 38.85 MHz
2nd: 450 kHz
for DSC 1st: 30.4 MHz
2nd: 450 kHz
Sensitivityfor Voice 0.25 μ V for 12 dB SINAD
for DSC 0.5 μ V for 12 dB SINAD
Adjacent Channel Selectivity 70 dB typical
Intermodulation..... 70 dB typical
Hum & Noise Ratio.....40 dB
Selectivity 12 kHz / 25 kHz (-6 dB / -60 dB)
AF Output (Internal SP)..... 700 mW @16 Ω for 10 % THD (@7.4 V)

21.4 GPS

Receiver Channels66 Channels
Sensitivity Less than -147 dBm
Time to First Fix..... 1 min typical (@Cold Start)
5 sec typical (@Hot Start)
Geodetic Datum..... WGS84

21.5 NMEA OUTPUT

NMEA 0183 Output Sentence (9600 baud)..... DSC, DSE, GGA, GLL,
RMC, GSA & GSV

22 FCC RADIO LICENSE INFORMATION

Standard Horizon radios comply with the Federal Communication Commission (FCC) requirements that regulate the Maritime Radio Service.

22.1 STATION LICENSE

An FCC ship station license is no longer required for any vessel traveling in U.S. waters (except Hawaii) which is under 20 meters in length. However, any vessel required to carry a marine radio on an international voyage, carrying a HF single side band radiotelephone or marine satellite terminal is required to have a ship station license. FCC license forms, including applications for ship (605) and land station licenses can be downloaded via the Internet at <http://www.fcc.gov/Forms/Form605/605.html>. To obtain a form from the FCC, call (888) 225-5322.

22.2 RADIO CALL SIGN

Currently the FCC does not require recreational boaters to have a Ship Radio Station License. The USCG recommends the boats registration number and the state to be used when calling another vessel.

22.3 CANADIAN SHIP STATION LICENSING

You may need a license when traveling in Canada. If you do need a license contact their nearest field office or regional office or write:

Industry Canada
Radio Regulatory Branch
Attn: DOSP
300 Slater Street
Ottawa, Ontario
Canada, KIA 0C8

22.4 FCC / INDUSTRY CANADA INFORMATION

The following data pertaining to the transceiver is necessary to fill out the license application.

Type Acceptance FCC Part 80
Output Power..... 1 Watt (low), 2 Watts (medium) and 6 Watts (high)
Emission 16K0G3E, 16K0G2B
Frequency Range 156.025 to 163.275 MHz
FCC Type Number..... K6630573X30
Industry Canada Type Approval 511B-30573X30

23 RF EXPOSURE SAFETY STATEMENT

SAFETY INFORMATION

Your wireless handheld portable transceiver contains a low power transmitter. When the Push-to-Talk (PTT) button is pushed, the transceiver sends out radio frequency (RF) signals. In August 1996, the Federal Communications Commission adopted RF exposure guidelines with safety levels for hand-held wireless devices.

This device is authorized to operate at a duty factor not to exceed 50 % (this corresponds to 50% transmission time and 50 % reception time).

WARNING: To maintain compliance with the FCC's RF exposure guidelines, this transmitter and its antenna must maintain a separation distance of at least 1 inch (2.5 centimeters) from your face. Speak in a normal voice, with the antenna pointed up and away from the face at the required separation distance.

If you use a headset accessory for this radio, with the radio worn on your body, use only the Yaesu belt clip for this transceiver, and ensure that the antenna is at least 1 inch (2.5 centimeters) from your body when transmitting.

Use only the supplied antenna. Unauthorized antennas, modifications, or attachments could damage the transmitter, and may violate FCC regulations.

CONSIGNES DE SECURITE

Votre émetteur-récepteur portable sans fil contient un émetteur à faible puissance. Lorsque vous appuyez sur le bouton Push-to-Talk (PTT), l'émetteur-récepteur émet des signaux de radiofréquence (RF). En août 1996, la FCC (Commission Fédérale des Communications) a adopté des directives relatives à l'exposition aux RF avec des niveaux de sécurité pour les appareils sans fils portatifs.

Le fonctionnement de cet appareil est autorisé à un facteur d'utilisation ne dépassant pas 50 % (correspondant à 50% de la durée de transmission et 50% de la durée de réception).

AVERTISSEMENT: Pour assurer la conformité avec les directives d'exposition RF de la FCC, cet émetteur-récepteur et son antenne doivent être maintenus à une distance minimum d'un pouce (2,5 centimètre) de votre visage. Parlez avec une voix normale, avec l'antenne dirigée vers le haut et éloignée du visage, à la distance requise.

Si vous utilisez un casque pour cette radio, et que vous portez la radio sur vous, utilisez exclusivement le clip de ceinture Yaesu pour cet émetteur-récepteur, et assurez-vous que l'antenne se trouve à une distance minimum d'un pouce (2,5 centimètres) de votre corps pendant l'émission.

Utilisez exclusivement l'antenne fournie. Les antennes, les modifications ou les accessoires non autorisés peuvent endommager l'émetteur-récepteur et enfreindre les réglementations FCC.

24 FCC NOTICE

NOTICE

Unauthorized changes or modifications to this equipment may void compliance with FCC Rules. Any change or modification must be approved in writing by STANDARD HORIZON.

NOTICE

This equipment has been tested and found to comply with the limits for a Class B digital device, pursuant to Part 15 of the FCC Rules. These limits are designed to provide reasonable protection against harmful interference in a residential installation. This equipment generates, uses and can radiate radio frequency energy and, if not installed and used in accordance with the instructions, may cause harmful interference to radio communications. However, there is no guarantee that interference will not occur in a particular installation. If this equipment does cause harmful interference to radio or television reception, which can be determined by turning the equipment off and on, the user is encouraged to try to correct the interference by one or more of the following measures:

- Reorient or relocate the receiving antenna.
- Increase the separation between the equipment and receiver.
- Connect the equipment into an outlet on a circuit different from that to which the receiver is connected.
- Consult the dealer or an experienced radio/TV technician for help.

SVIB

SVIB

THIS DEVICE COMPLIES WITH PART 15 OF THE FCC RULES. OPERATION IS SUBJECT TO THE FOLLOWING TWO CONDITIONS: (1) THIS DEVICE MAY NOT CAUSE HARMFUL INTERFERENCE, AND (2) THIS DEVICE MUST ACCEPT ANY INTERFERENCE RECEIVED, INCLUDING INTERFERENCE THAT MAY CAUSE UNDESIRE OPERATION.

Changes or modifications to this device not expressly approved by YAESU U.S.A. could void the User's authorization to operate this device.

This device complies with Industry Canada license-exempt RSS standard(s). Operation is subject to the following two conditions: (1) this device may not cause interference, and (2) this device must accept any interference, including interference that may cause undesired operation of the device.

Le présent appareil est conforme aux CNR d'Industrie Canada applicables aux appareils radio exempts de licence. L'exploitation est autorisée aux deux conditions suivantes : (1) l'appareil ne doit pas produire de brouillage, et (2) l'utilisateur de l'appareil doit accepter tout brouillage radioélectrique subi, même si le brouillage est susceptible d'en compromettre le fonctionnement.

Under Industry Canada regulations, this radio transmitter may only operate using an antenna of a type and maximum (or lesser) gain approved for the transmitter by Industry Canada. To reduce potential radio interference to other users, the antenna type and its gain should be so chosen that the equivalent isotropically radiated power (e.i.r.p.) is not more than that necessary for successful communication.

Conformément à la réglementation d'Industrie Canada, le présent émetteur radio peut fonctionner avec une antenne d'un type et d'un gain maximal (ou inférieur) approuvé pour l'émetteur par Industrie Canada. Dans le but de réduire les risques de brouillage radioélectrique à l'intention des autres utilisateurs, il faut choisir le type d'antenne et son gain de sorte que la puissance isotrope rayonnée équivalente (p.i.r.e.) ne dépasse pas l'intensité nécessaire à l'établissement d'une communication satisfaisante.

This radio transmitter (identify the device by certification number, or model number if Category II) has been approved by Industry Canada to operate with the antenna types listed below with the maximum permissible gain and required antenna impedance for each antenna type indicated. Antenna types not included in this list, having a gain greater than the maximum gain indicated for that type, are strictly prohibited for use with this device.

Le présent émetteur radio (identifier le dispositif par son numéro de certification ou son numéro de modèle s'il fait partie du matériel de catégorie I) a été approuvé par Industrie Canada pour fonctionner avec les types d'antenne énumérés ci-dessous et ayant un gain admissible maximal et l'impédance requise pour chaque type d'antenne. Les types d'antenne non inclus dans cette liste, ou dont le gain est supérieur au gain maximal indiqué, sont strictement interdits pour l'exploitation de l'émetteur. l'établissement d'une communication satisfaisante.



YAESU U.S.A.

6125 Phyllis Drive, Cypress, California 90630

www.standardhorizon.com



E M O S 7 N 1 0 0

Copyright 2014
YAESU MUSEN CO., LTD.
All rights reserved.

No portion of this manual
may be reproduced
without the permission of
YAESU MUSEN CO., LTD.

Printed in China